

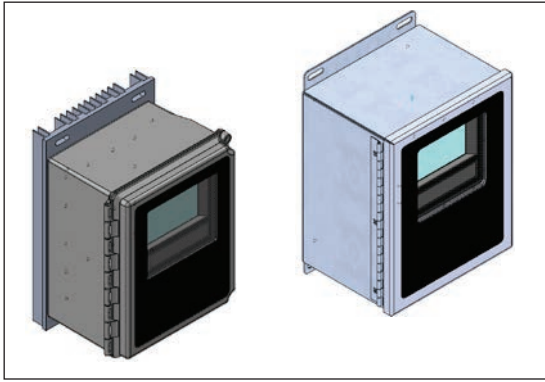

Elexant 4010i

Installation Instructions



DESCRIPTION

The nVent RAYCHEM Elexant 4010i is a compact, full-featured, touch screen based, single-point heat-tracing controller. It provides control and monitoring of Electric Heat Tracing (EHT) circuits for both freeze protection and process temperature maintenance. This controller can monitor and alarm on high and low temperature, high and low current, ground-fault levels, voltage, and supports a host of additional features to offer the utmost in control and monitoring of EHT.

TOOLS REQUIRED

- 3 mm head flat blade screwdriver for IO terminal
- 5 mm head flat blade screwdriver for power terminals

APPROVALS

Hazardous Locations (SSR Variants)



E4905419
Proc. Cont. Eq.
Use in Haz. Loc.
(Associated Apparatus)



Class I, Division 2, Group A, B, C, D T4 Type 4X
Class I, Zone 2, AEx nA nC [ia Ga] IIC T4 Gc
Ex ec nC [ia Ga] IIC T4 Gc
IP64 (FW) IP66 (SW)
UL 21 ATEX 2616X (for IS versions only)
DEMKO 18 ATEX 2091 X (for non- IS versions)
UL21UKEX2316X
II 3 (1)G Ex ec nC [ia Ga] IIC T4 Gc
IP64 (FW) IP66 (SW)
IECEX UL 18 .0098X

Non-Hazardous Locations (EMR & SSR Variants)



E498881
Proc. Cont. Eq.

Enclosure Type 4X
IP64 (FW) IP66 (SW)

IS Temperature Sensor Inputs (Optional) $U_m = 305VAC$
Associated Apparatus $U_o = 5.4V$ $C_a = 65\mu F$
Entity Parameters $I_o = 0.083A$ $L_a = 2mH$

VARIANTS (NOT ALL VARIANTS ARE AVAILABLE IN ALL REGIONS)

Type	Description
4010i-EMR-FW	Elexant 4010i controller in an 8 in x 10 in FRP enclosure with window and 2-pole 32A EMR. Controls a single circuit with a 2-pole electromechanical relay. (Approved for non-hazardous locations only)
4010i-SSR-FW	Elexant 4010i controller in an 8 in x 10 in FRP enclosure with window and 2-pole 32A 277V SSR. Controls a single circuit with a 2-pole solid-state relay. (Approved for Class I, Div. 2/Zone 2 locations)
4010i-EMR-SW	Elexant 4010i controller in an 8 in x 10 in stainless steel enclosure with window and 2-pole 32A EMR. Controls a single circuit with a 2-pole electromechanical relay. (Approved for non-hazardous locations only)
4010i-SSR-SW	Elexant 4010i controller in an 8 in x 10 in stainless steel enclosure with window and 2-pole 32A 277V SSR. Controls a single circuit with a 2-pole solid-state relay. (Approved for Class I, Div. 2 /Zone 2 locations)
4010i-EMR-IS-FW	Elexant 4010i controller in an 8 in x 10 in FRP enclosure with window and 2-pole 32A EMR. Controls a single circuit with a 2-pole electromechanical relay. Includes intrinsically safe barriers on RTD inputs. (Approved for non-hazardous locations only. RTDs may be placed in Class I, Div.2/Zone 2 , Div.1/Zone 1 locations)
4010i-SSR-IS-FW	Elexant 4010i controller in an 8 in x 10 in FRP enclosure with window and 2-pole 32A 277V SSR. Controls a single circuit with a 2-pole solid state relay. Includes intrinsically safe barriers on RTD inputs. (Approved for Class I, Div. 2/Zone 2 locations, RTDs may be placed in Class I, Div. 2/Zone 2, Div. 1/Zone 1 locations)
4010i-EMR-IS-SW	Elexant 4010i controller in an 8 in x 10 in stainless steel enclosure with window and 2-pole 32A EMR. Controls a single circuit with a 2-pole electromechanical relay. Includes intrinsically safe barriers on RTD inputs. (Approved for non-hazardous locations only. RTDs may be placed in Class I, Div. 2/Zone 2 , Div. 1/Zone 1 locations)
4010i-SSR-IS-SW	Elexant 4010i controller in an 8 in x 10 in stainless steel enclosure with window and 2-pole 32A 277V SSR. Controls a single circuit with a 2-pole solid-state relay. Includes intrinsically safe barriers on RTD inputs. (Approved for Class I, Div. 2 /Zone 2 locations, RTDs may be placed in Class I, Div. 2/Zone 2, Div.1/Zone 1 locations)
4010i-Mod	Elexant 4010i Module (replacement)
4010i-Mod-IS	Elexant 4010i Module with IS Barrier (replacement)

WARNING:

This component is an electrical device that must be installed correctly to ensure proper operation and to prevent shock or fire.

GENERAL

Supply voltage	100Vac to 277Vac, +/-10%, 50-60Hz
Internal power consumption	< 24W
Electromagnetic Compatibility	IEC 61326-1:2012 / EN 61326-1:2013

ENVIRONMENTAL

Protection	Type 4X, IP64 (FRP enclosure) Type 4X, IP66 (stainless steel enclosure)
Materials	Fiber-Reinforced Plastic (FRP) or stainless steel (SS304)
Ambient operating temperature	-40°C to 60°C (-40°F to 140°F)
Ambient storage temperature	-55°C to 85°C (-67°F to 185°F)
Relative humidity	0% to 90%, noncondensing
Environment	PD2, CAT III
Max altitude	2,000 m (6,562 ft)

CONTROL

Relay Type	Double-pole, mechanical (EMR versions) Double-pole, solid-state (SSR versions)
Voltage, maximum	277Vac nominal, 50/60Hz
Current, maximum	32A @ 40°C, de-rated to 24A @ 50°C and further de-rated to 16A @ 60°C (EMR) 32A @ 40°C, de-rated to 24A @ 50°C and further de-rated to 16A @ 60°C (SSR)

TEMPERATURE SENSOR INPUTS

Quantity Three temperature inputs each of which can be individually set to one of the types below.

Types

100Ω platinum RTD	3-wire, $\alpha=0.00385$ ohms/ohm/°C Can be extended with a 3-conductor shielded cable of 20Ω maximum per conductor
100Ω nickel iron RTD	2-wire, $\alpha=0.00599$ ohms/ohm/°C Can be extended with a 2-conductor shielded cable of 20Ω maximum per conductor
100Ω nickel RTD	2-wire, $\alpha=0.00618$ ohms/ohm/°C Can be extended with a 2-conductor shielded cable of 20Ω maximum per conductor
Thermocouple	Requires external 4-20mA converter 4-20mA current loop, ± 0.05 mA, 24Vdc loop power provided in device, external loop power can also be used

Intrinsic Safety Barriers included on RTD Inputs when using IS models.

RTD Intrinsic Safety Associated Apparatus Entity Parameters

U_o (Maximum Output Voltage): 5.4V L_a (Maximum External Inductance): 2mH
I_o (Maximum Output Current): 0.083A C_a (Maximum External Capacitance): 65uF
P_o (Maximum Output Power): 0.449W

DIGITAL INPUTS

Quantity Two multi-purpose inputs for connection to external dry (voltage free) contact or DC voltage
Rating 100 Ω max loop resistance or 5-24Vdc @ 1 mA maximum

OUTPUTS

Alarm Relay Form-C dry contact: 100Vac to 277Vac, 3A, 50/60Hz
Auxiliary Output 24Vdc, max load of 250 mA @ 40°C,
de-rated to 165 mA @ 60°C

CONNECTION TERMINALS

Power Supply Input Screw terminals, 24 – 5 AWG (0.2 – 16.8 mm²)
Heating Cable output Screw terminals, 24 – 5 AWG (0.2 – 16.8 mm²)
Torque Range for Screw Terminals 1.2 – 1.5 Nm
Ground (Earth) Three box lugs, 14 – 2 AWG (2.0 – 33.6 mm²)
Sensor / Other terminals Cage clamp terminals, 28 – 12 AWG (0.08 – 3.3 mm²)
Minimum Conductor Temp. Rating 80°C

MOUNTING

FRP enclosure with EMR Surface mounting with four holes on 6.0 in x 10.9 in (152 mm x 278 mm) centers
Hole diameter: 0.3 in (8 mm)
FRP enclosure with SSR Surface mounting with four holes on 5.6 in x 11.0 in (143 mm x 279 mm) centers
Hole diameter: 0.3 in (8 mm)
Stainless steel enclosure with EMR Surface mounting with four holes on 6.0 in x 11.0 in (152 mm x 279 mm) centers
Hole diameter: 0.3 in (8 mm)
Stainless steel enclosure with SSR Surface mounting with four holes on 5.6 in x 11.0 in (143 mm x 279 mm) centers
Hole diameter: 0.3 in (8 mm)

CONNECTIONS AND INDICATORS

A. TB1 Wiring

Terminals	Function
1	TS1 (White)
2	TS1 (Red)
3	TS1 (Red)
4	TS2 (White)
5	TS2 (Red)
6	TS2 (Red)
7	TS3 (White)
8	TS3 (Red)
9	TS3 (Red)
10	No Connect
11	No Connect
12	No Connect

B. TB2 Wiring

Terminals	Function
1	TC3+
2	TC2+
3	TC1+
4	TC3-
5	TC2-
6	TC1-
7	- No Connect
8	SSR-
9	SSR+
10	DIGITAL INPUT COM
11	DIGITAL INPUT 1
12	DIGITAL INPUT 2
13	RS485 IN+
14	RS485 IN-
15	RS485 COM
16	RS485 OUT+
17	RS485 OUT-
18	RS485 COM

C. TB1 Wiring

Terminals	Function
1	24V+ OUT
2	- No Connect
3	Output Relay
4	24V COM
5	External Jumper Required
6	External Jumper Required
7	Alarm_NC
8	Alarm_COM
9	Alarm_NO

D. TB4 Wiring

Terminals	Function
1	EGND
2	POWER IN (L1)
3	POWER IN (L2/N)
4	LOAD OUT (L1)
5	LOAD OUT (L2/N)

E. Status LEDs

Status:	Indicates status of Elexant 4010i module
Off	No power
Green	Normal operation, no internal faults
Red	Device Reset
Flash R/G	Unlocked/Calibrated

Output Shows status of switched output

COMM

Flash Green	Receive Active
Flash Red	Transmit Active

Alarm

Red	Illuminates when an alarm is present
-----	--------------------------------------

F. USB Connector

G. Ethernet Connection

⚠ WARNING: Shock Hazard.
Disconnect from live voltage prior to accessing terminals

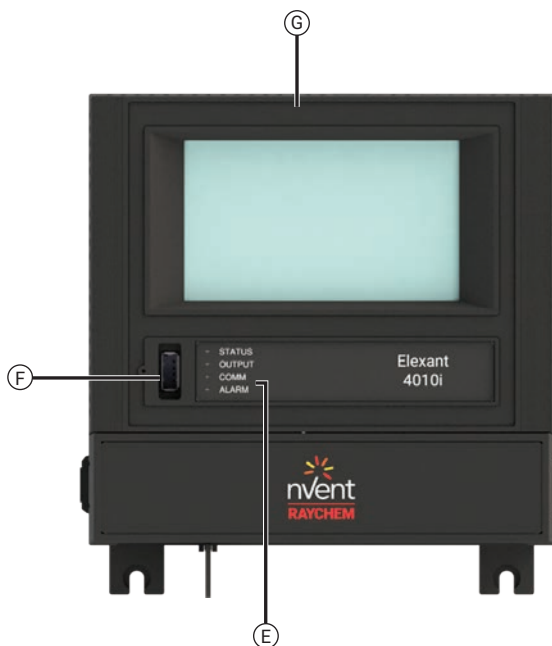
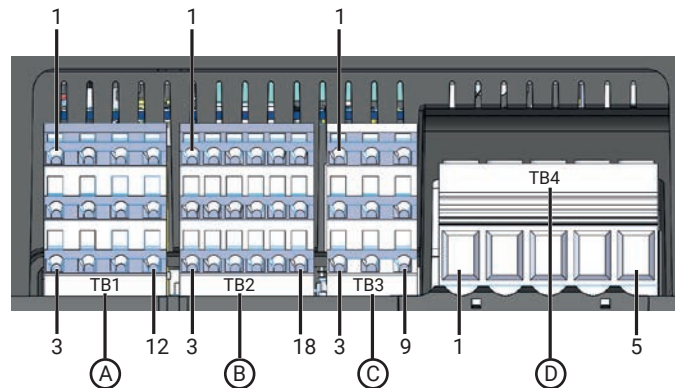

MOUNTING THE ELEXANT 4010i CONTROLLER

- SSR version should ideally be mounted to channel strut to maximize heat sink ventilation.
- EMR version can be mounted against a flat surface using the attached mounting feet.
- Secure the enclosure using the upper and lower mounting slots in the heat sink or the mounting feet using hex head screws, flat & lock-washers washers or equivalent hardware.

SSR version

SAE ¼" x 2" long (Grade 2, 5, 8 : Torque to 4 ft-lb, 7 ft-lb, 9ft-lb respectively)

Metric 6 mm x 50 mm (Grade 4.6, 8.8 : Torque to 6-Nm 12-Nm respectively)

EMR version

SAE ¼" x ¾" long

Metric 6 mm x 20 mm

[inches] mm

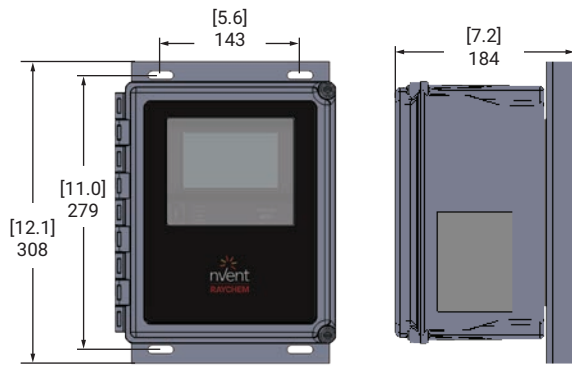

Fiber-Reinforced Plastic (FRP) Enclosure with SSR

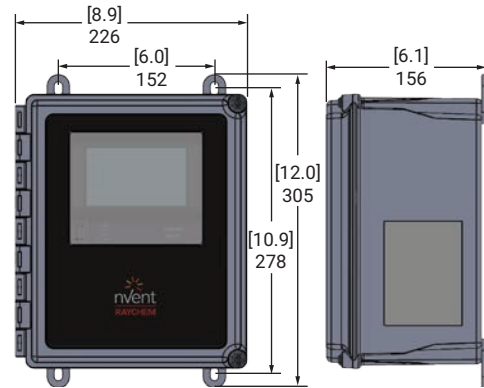

Fiber-Reinforced Plastic (FRP) Enclosure with EMR

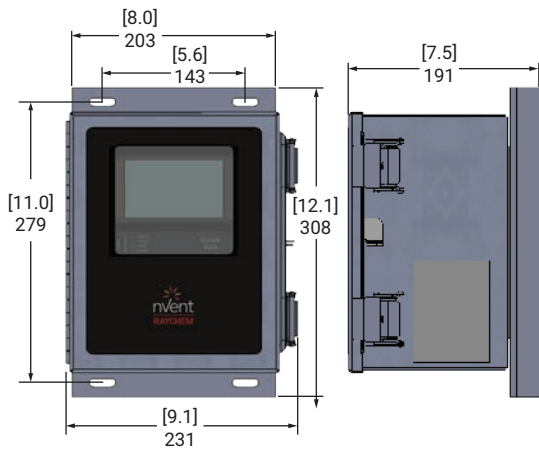

Stainless Steel Enclosure with SSR

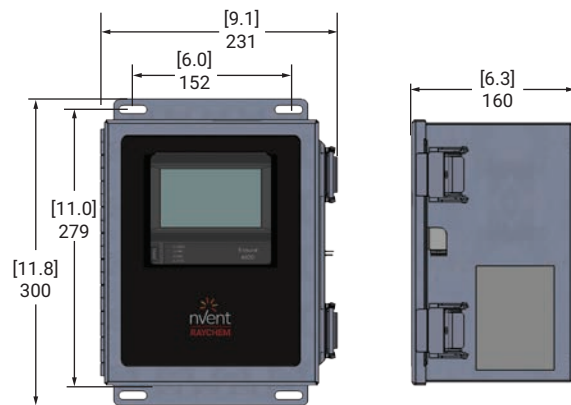

Stainless Steel Enclosure with EMR

1. INPUT POWER

The input power connection is made at the screw terminals on TB-4.
Refer to the Connections section on page 3 for terminal block details.
The incoming ground connection should be terminated on the field terminal block located on the mounting plate.

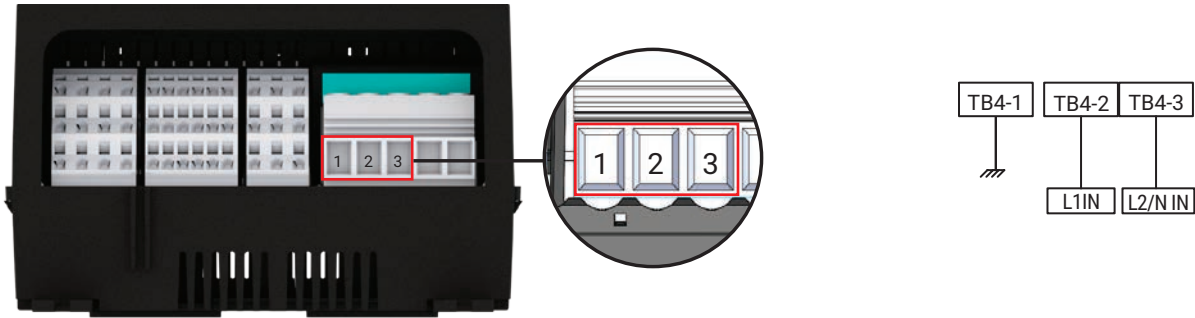

2. LOAD CONNECTIONS

Connections made to the load using screw terminals on TB4.
All variants use the same output connection.
Refer to the Connections section on page 3 for terminal block details.
Load ground terminations are to be made on the field terminal block located on the mounting plate.

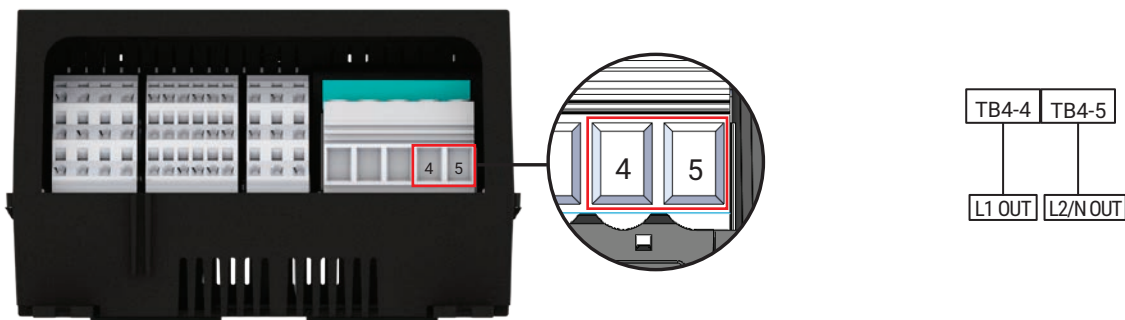

3. 3-WIRE RTD CONNECTIONS

Terminate RTD field wires to terminal block TB1.
Refer to the Connections section on page 3 for terminal block details.
Terminate cable shields on the field terminal block located on the mounting plate.

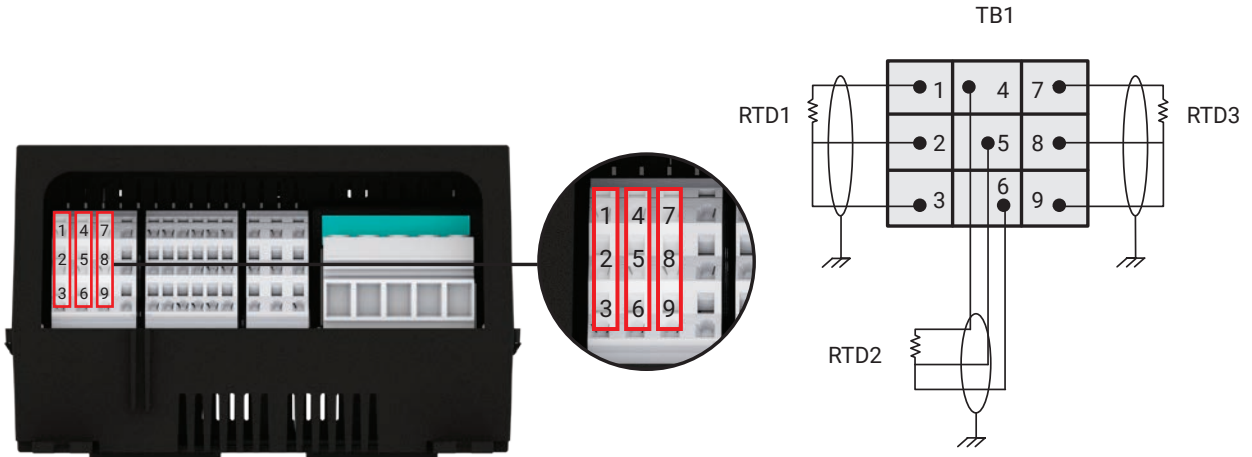

4. 2-WIRE RTD CONNECTIONS

Terminate RTD field wires to terminal block TB1.
Refer to the Connections section on page 3 for terminal block details.
Terminate cable shields on the field terminal block located on the mounting plate.

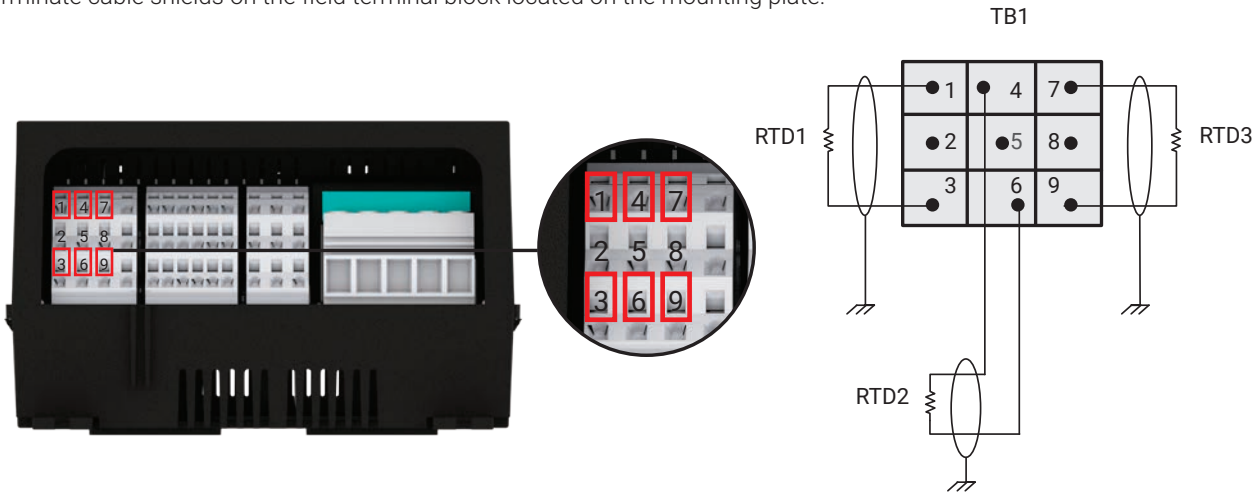

5. 4-20 MA CONNECTIONS

Wiring for 4-20 mA connections are made directly to the terminal block TB2.
Refer to the CONNECTIONS section on page 3 for terminal block details.
Terminate cable shields on the field terminal block located on the mounting plate.

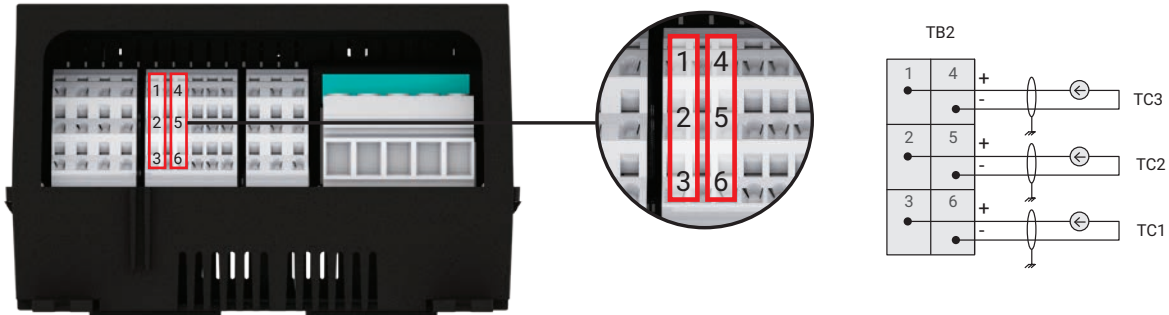

6. ALARM RELAY

The multi-purpose alarm relay is energized in the normal state (No Alarms) and is configured as Fail Safe.
The alarm relay connections provide a Form-C dry contact, rated at 277 V max (3 A).

Refer to the CONNECTIONS section on page 3 for terminal block details.

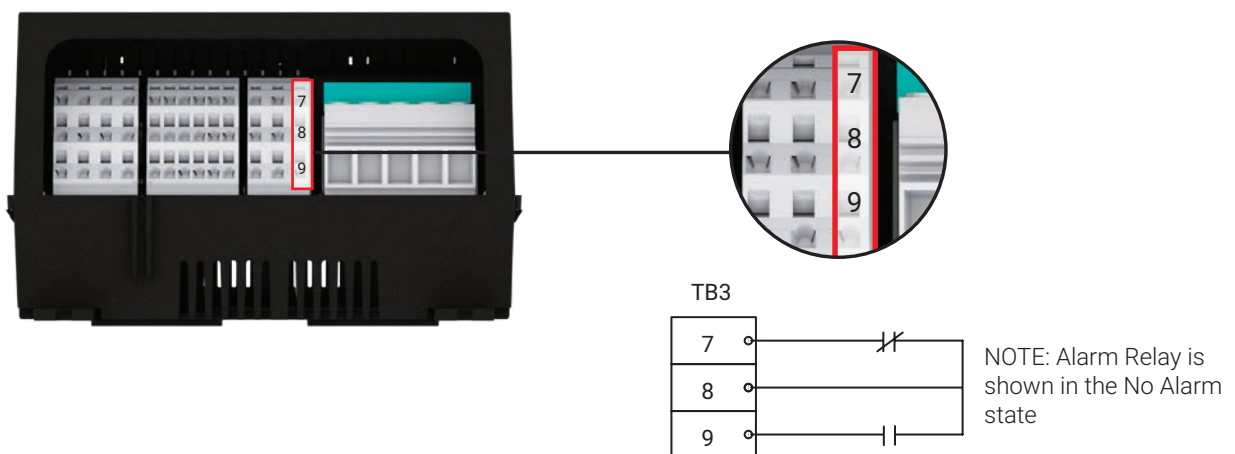

7. RS-485 IN

Wiring for RS-485 communications must be made directly to the terminal block TB2.
No shield wires should be terminated on the terminals of TB2.
Refer to the Connections section on page 3 for terminal block details.
Terminate cable shields on the field terminal block located on the mounting plate.

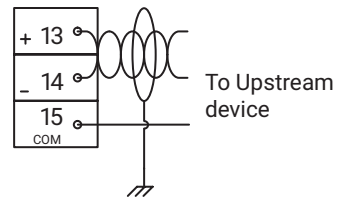
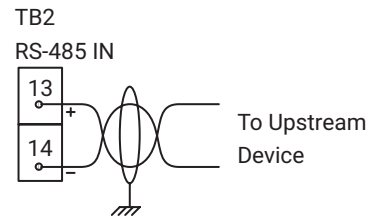
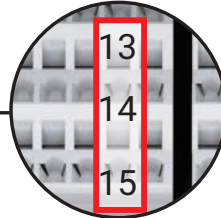
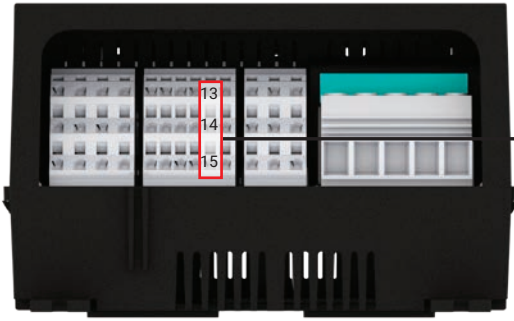

For best performance, an additional third signal ground wire is connected between COM and the signal ground of the upstream device. This wiring method will reduce noise induced through ground potential differences.

8. RS-485 OUT

Wiring for RS-485 communications must be made directly to the terminal block TB2.
No shield wires should be terminated on the terminals of TB2.
Refer to the Connections section on page 3 for terminal block details.
Terminate cable shields on the field terminal block located on the mounting plate.

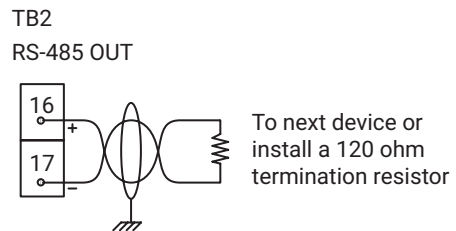
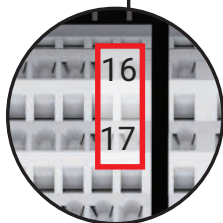

Note: Install a 120 ohm termination resistor as shown if this is the last device in the communications bus

9. ETHERNET

An Ethernet connection is made via the RJ45 connector using a CAT 5E cable, terminated with an RJ45 connector.

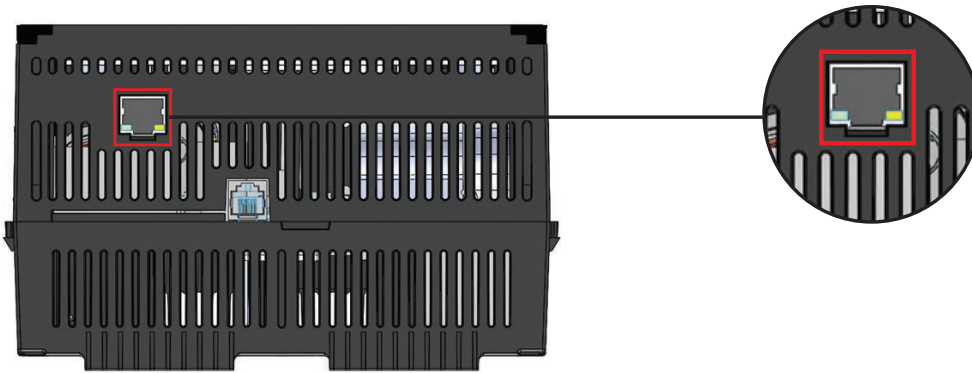

10. DIGITAL INPUTS

Digital Inputs Multi-purpose input for connection to external dry (voltage free) contact or DC voltage.
 Rating 100 Ω max loop resistance or 5-24 Vdc @ 1 mA maximum

Refer to the CONNECTIONS section for terminal block details.

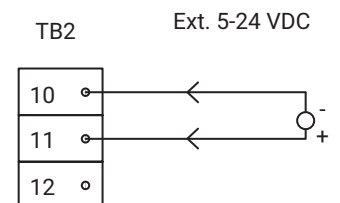
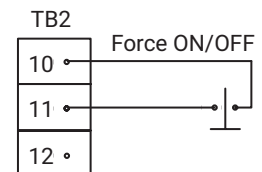
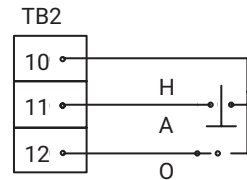
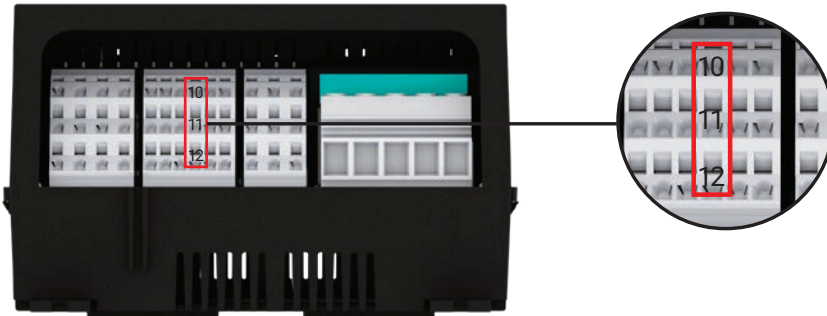

11. AUX 24V OUTPUT

This 24VDC output may be used to power peripheral equipment if required. The connection is made using TB3.

Refer to the CONNECTIONS section on page 3 for terminal block details.

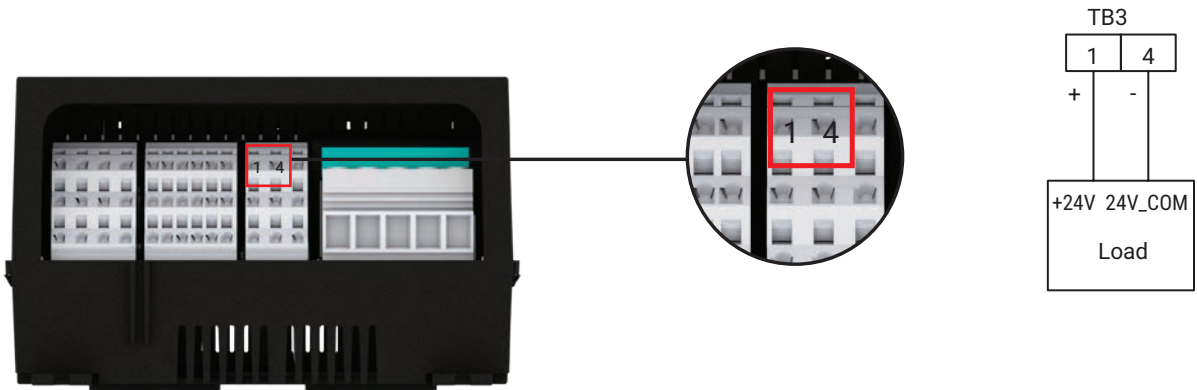

12. USB CONNECTOR

The USB connector on the front of the unit can be used to import and export User setting configurations for ease of programming units and uploading of new firmware.



13. INTRINSIC SAFETY RTD CONNECTIONS – IF EQUIPPED

For models that include Intrinsic Safety barriers for the RTD connections, the terminal block TB1 will be blue. Each RTD wiring pair is to be considered a separate circuit.

RTD1 Circuit: TB1-1, TB1-2, TB1-3

RTD2 Circuit: TB1-4, TB1-5, TB1-6

RTD3 Circuit: TB1-7, TB1-8, TB1-9

Associated Apparatus Entity Parameters

Uo (Maximum Output Voltage): 5.4V

Io (Maximum Output Current): 0.083A

Po (Maximum Output Power): 0.449W

La (Maximum External Inductance): 2mH

Ca (Maximum External Capacitance): 65uF

The output current of this associated apparatus is limited by a resistor such that the output voltage-current plot is a straight line drawn between open-circuit voltage and short-circuit current.

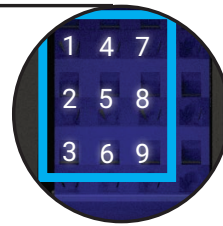

Intrinsically Safe RTD Terminal Connection

Class I, Division 2, Group A,B,C,D
Class I, Zone 2, Group IIC
IEC EX/ATEX/UKEx Zone 2



Class I, Div 1, Group A, B, C, D
Class I, Zone 1, Group IIC
Class I, Zone 0, Group IIC
IEC EX/ATEX/UKEx Zone 1, Zone 0

RTD

Specific Conditions of Use

This associated apparatus is intended for connection only to simple apparatus as defined in:

- Article 504.2 and installed and temperature classified in accordance with Article 504.10(D) of the National Electrical Code (ANSI/NFPA 70)
- Clause 3.5.5 and installed and temperature classified in accordance with Clause 16.4 of IEC 60079-14
- Section F3 in Appendix F and installed and temperature classified in accordance with Section F4.2 in Appendix F of the Canadian Electrical Code, Part 1 (C22.1)
- Or other local codes, as applicable.

When connecting to simple apparatus, the cable length shall not exceed 3000m (9842ft).

Associated apparatus must be installed in an enclosure suitable for the application in accordance with the National Electrical Code (ANSI/NFPA 70) for installation in the United States, the Canadian Electrical Code for installations in Canada, or other local codes, as applicable.

The associated apparatus must be connected to a suitable ground electrode per the National Electrical Code (ANSI/NFPA 70), the Canadian Electrical Code or other local installation codes, as applicable. The resistance of the ground path must be less than 1 ohm.

Where multiple circuits extend from the same piece of associated apparatus, they must be installed in separate cables or in one cable having suitable insulation. Refer to Article 504.30(B) of the National Electrical Code (ANSI/NFPA 70) and Instrument Society of America Recommended Practice ISA RP12.06 for installing intrinsically safe equipment.

Intrinsically safe circuits must be wired and separated in accordance with:

- Article 504.20 of the National Electrical Code (ANSI/NFPA 70)
- Clause 16.2 of IEC 60079-14
- Section F4.2 in Appendix F of the Canadian Electrical Code, Part 1 (C22.1)
- or other local codes, as applicable.

This associated apparatus has not been evaluated for use in combination with another associated apparatus.

Control equipment must not use or generate more than 305 V rms (U_m) or dc with respect to earth.

- The enclosure of the device shall be fitted with a locking mechanism such that it is only accessible with the use of a tool.
- Provisions shall be made, external to the apparatus, to provide the transient protection device to be set at a level not exceeding 140% of the rated voltage at the input terminals of this apparatus.
- To maintain an internal pollution degree 2 environment, after opening the enclosure, make sure there is no visible condensation or dust. Power the device and let it heat up for 5 minutes before closing the enclosure door.
- Only install in areas with low risk of mechanical impact.
- 4010i-Mod and 4010i-Mod-IS replacement modules must be installed into existing ATEX/UKEx/IECEx Zone 2 certified Elexant 4010i enclosures.

 **WARNING: Explosion Hazard – Substitution of components may impair suitability for Class I, Division 2 hazardous and nonhazardous locations**

 **AVERTISSEMENT – Risque D'explosion – La substitution de composants peut rendre ce matériel inacceptable pour les emplacements de Classe I, Division 2**

 **WARNING: Explosion Hazard – Do not disconnect equipment unless power has been switched off or the area is known to be nonhazardous**

 **AVERTISSEMENT – Risque D'explosion – Avant de débrancher l'équipement, couper le courant ou s'assurer que l'emplacement est désigné non dangereux**

 **WARNING: Explosion Hazard – To prevent the risk of electrostatic discharge, only clean the equipment enclosure with a damp cloth**

 **AVERTISSEMENT – Risque D'explosion – Pour éviter tout risque de décharge électrostatique, ne nettoyez le boîtier de l'appareil qu'avec un chiffon humide**

The Elexant 4010i contains no user serviceable parts. Contact your nVent representative for service and a Return Authorization number if required.

North America

nVent
899 Broadway
Redwood City, CA 94063
United States
Tel +1.800.545.6258
Fax +1.800.527.5703
thermal.info@nVent.com

Europe, Middle East, Africa

nVent
Romeinse straat 14
3001 Leuven
Belgium
Tel +32.16.213.511
Fax +32.16.213.604
thermal.info@nVent.com

North America

Tel +1.800.545.6258
Fax +1.800.527.5703
thermal.info@nVent.com

Europe, Middle East, Africa

Tel +32.16.213.511
Fax +32.16.213.604
thermal.info@nVent.com

Asia Pacific

Tel +86.21.5426.2937
Fax +86.21.2412.1688
cn.thermal.info@nVent.com

Latin America

Tel +1.713.868.4800
Fax +1.713.868.2333
thermal.info@nVent.com



[nVent.com/RAYCHEM](https://www.nVent.com/RAYCHEM)