

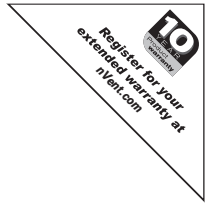

RAYCHEM



Industrial Heat-Tracing

Installation and Maintenance
Manual For Self-Regulating and
Power-Limiting Heating Cable Systems

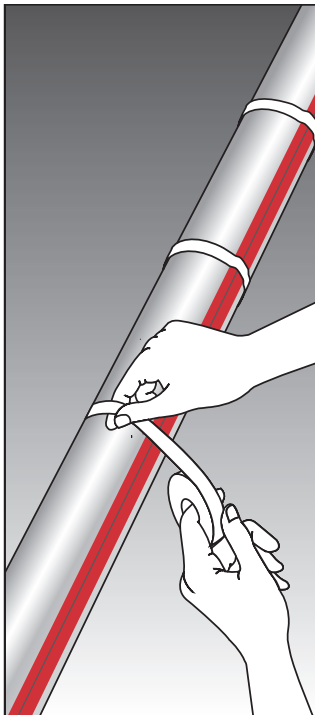

Important Safeguards and Warnings

WARNING: FIRE AND SHOCK HAZARD.

nVent RAYCHEM heat-tracing systems must be installed correctly to ensure proper operation and to prevent shock and fire. Read these important warnings and carefully follow all the installation instructions.

- To minimize the danger of fire from sustained electrical arcing if the heating cable is damaged or improperly installed, and to comply with nVent requirements, agency certifications, and national electrical codes, ground-fault equipment protection must be used on each heating cable branch circuit. Arcing may not be stopped by conventional circuit breakers.
- Approvals and performance of the heat-tracing systems are based on the use of nVent specified parts only. Do not substitute parts or use vinyl electrical tape.
- Bus wires will short if they contact each other. Keep bus wires separated.
- Components and cable ends must be kept dry before and during installation.
- The black heating cable core and fibers are conductive and can short. They must be properly insulated and kept dry.
- Damaged bus wires can overheat or short. Do not break bus wire strands when preparing the cable for connection.
- Damaged heating cable can cause electrical arcing or fire. Do not use metal attachments such as pipe straps or tie wire. Use only nVent RAYCHEM approved tapes and cable ties to secure the cable to the pipe.
- Do not attempt to repair or energize damaged cable. Remove damaged cable at once and replace with a new length using the appropriate nVent RAYCHEM splice kit. Replace damaged components.
- Re-use of the grommets, or use of the wrong grommet, can cause leaks, cracked components, shock, or fire. Be sure the type of grommet is correct for the heating cable being installed. Use a new grommet whenever the cable has been pulled out of the component.
- Use only fire-resistant insulation which is compatible with the application and the maximum exposure temperature of the system to be traced.
- To prevent fire or explosion in hazardous locations, verify that the maximum sheath temperature of the heating cable is below the auto-ignition temperature of the gases in the area. For further information, see the design documentation.
- Material Safety Data Sheets (MSDSs) are available on-line at nVent.com.

Table of Contents

1	General Information	5
	1.1 Use of the Manual	5
	1.2 Safety Guidelines	5
	1.3 Electrical Codes	6
	1.4 Warranty and Approvals	6
	1.5 General Installation Notes	6

2	Heating Cable Selection	7
----------	-------------------------	---

3	Heating Cable Installation	8
	3.1 Heating Cable Storage	8
	3.2 Pre-Installation Checks	8
	3.3 Installation	9

4	Heating Cable Components	20
	4.1 General Component Information	20

5	Control and Monitoring	24
----------	------------------------	----

6	Thermal Insulation	26
	6.1 Pre-Insulation Checks	26
	6.2 Insulation Installation Hints	26
	6.3 Marking	26
	6.4 Post-Insulation Testing	26

7	Power Supply and Electrical Protection	27
	7.1 Voltage Rating	27
	7.2 Electrical Loading	27
	7.3 Ground-Fault Protection	27

8	Commissioning and Preventive Maintenance	28
	8.1 Tests	28
	8.2 Preventive Maintenance	29

9	Test Procedures	31
	9.1 Visual Inspection	31
	9.2 Insulation Resistance (Megger) Test	31
	9.3 Continuity check	34
	9.4 Power Check	34
	9.5 Fault Location Tests	35

10	Troubleshooting Guide	40
-----------	-----------------------	----

11	Installation and Inspection Records	44
-----------	-------------------------------------	----

1

General Information

1.1 Use of the Manual

This installation and maintenance manual is for nVent RAYCHEM Self-Regulating and Power-Limiting heat-tracing systems on thermally insulated pipes and vessels only. This includes nVent RAYCHEM BTV, HBTV, QTVR, HQTV, XTV, HXTV, HTV, KTV, VPL heating cables and the appropriate nVent RAYCHEM components.

For information regarding other applications, design assistance or technical support, contact your nVent representative or nVent directly.

nVent

7433 Harwin Drive
Houston, TX 77036 USA
Tel: +1.800.545.6258
Tel: +1.650.216.1526
Fax: +1.800.527.5703
Fax: +1.650.474.7711
thermal.info@nVent.com
nVent.com





Important: For the nVent warranty and agency approvals to apply, the instructions that are included in this manual and product packages must be followed.

1.2 Safety Guidelines

The safety and reliability of any heat-tracing system depends on proper design, installation and maintenance. Incorrect handling, installation, or maintenance of any of the system components can cause underheating or overheating of the pipe or damage to the heating cable system and may result in system failure, electric shock or fire.

Persons involved in the installation and testing of electric trace heating systems shall be suitably trained in all special techniques required. Installation shall be carried out under the supervision of a qualified person.

Pay special attention to the following:

- Important instructions are marked  **Important**
- Warnings are marked  **WARNING**

1

General Information

1.3 Electrical Codes

Sections 427 (pipelines and vessels) and 500 (classified locations) of the National Electrical Code (NEC), and Part 1 of the Canadian Electrical Code, Sections 18 (hazardous locations) and 62 (Fixed Electric Space and Surface Heating), govern the installation of electrical heat-tracing systems.

All heat-tracing-system installations must be in compliance with these and any other applicable national or local codes.

1.4 Warranty and Approvals

nVent RAYCHEM heating cables and components are approved for use in hazardous and nonhazardous locations. Refer to the specific product data sheets for details.

1.5 General Installation Notes

These notes are provided to assist the installer throughout the installation process and should be reviewed before the installation begins.

- Read all instruction sheets to familiarize yourself with the products.
- Select the heating cable type and rating in accordance with the Industrial Product Selection and Design Guide (nVent literature #H56550), or TraceCalc Pro software, or the website design software.
- Ensure all pipes, tanks, etc., have been released by the client for tracing prior to installation of the heating cables.
- Typically, heating cables are installed at the 4 and 8 o'clock positions on a pipe.
- All heat-traced pipes, tanks, vessels, and equipment must be thermally insulated.
- Do not install heating cables on equipment operating above the heating cable's maximum rated temperature.
- The minimum bending radius for VPL Power-Limiting cables is 3/4 inch (19 mm). The minimum bending radius for Self-Regulating cables is 1/2 inch (13 mm).
- Never install heating cables over expansion joints without leaving slack in the cable.
- Do not energize cable when it is coiled or on the reel.
- Never use tie wire or pipe straps to secure heating cables.

2

Heating Cable Selection

Cable	Minimum installation temperature per agency schedule			
	FM	cFMus	CSA	cCSAus
BTV-CT	-40°C / -40°F		-60°C / -76°F	-60°C / -76°F
BTV-CR	-40°C / -40°F		-60°C / -76°F	-60°C / -76°F
HBTV-CT	-40°C / -40°F			
LBTV	-40°C / -40°F		-60°C / -76°F	-60°C / -76°F
QTVR	-40°C / -40°F		-60°C / -76°F	-60°C / -76°F
HQTV	-40°C / -40°F			
KTV	-40°C / -40°F		-60°C / -76°F	-60°C / -76°F
XTV	-40°C / -40°F		-60°C / -76°F	-60°C / -76°F
HXTV	-40°C / -40°F			
HTV		-60°C / -76°F		-60°C / -76°F
VPL	-40°C / -40°F		-60°C / -76°F	-60°C / -76°F

Check the design specification to make sure the proper heating cable is installed on each pipe or vessel. Refer to the Industrial Product Selection and Design Guide, TraceCalc Pro or the nVent web site, nVent.com, to select the proper heating cable for your application.

3

Heating Cable Installation

3.1 Heating Cable Storage

- Store the heating cable in a clean, dry place. Temperature range: -40°F (-40°C) to 140°F (60°C).
- Protect the heating cable from mechanical damage.

3.2 Pre-Installation Checks

Check materials received:

- Review the heating cable design and compare the list of materials to the catalog numbers of heating cables and components received to confirm that proper materials are on site. The heating cable type and voltage is printed on its jacket.
- Ensure that the heating cable voltage rating is suitable for the service voltage available.
- Inspect the heating cable and components for in-transit damage.
- Verify that there are no holes in the heating cable jackets by conducting the insulation resistance test (refer to Section 9) on each reel of cable.

Check piping to be traced:

- Make sure all mechanical pipe testing (i.e. hydrostatic testing/purging) is complete and the system has been cleared by the client for tracing.
- Walk the system and plan the routing of the heating cable on the pipe.
- Inspect the piping for burrs, rough surfaces, or sharp edges. Remove if necessary.
- Verify that any surface coatings are dry to the touch.

3

Heating Cable Installation

3.3 Installation

Paying out the cable

Pay out the heating cable, loosely stringing it along the pipe, making sure that the cable is always next to the pipe when crossing obstacles. If the cable is on the wrong side of an obstacle such as a crossing pipe or I-beam, you will need to reinstall it or cut and splice it.

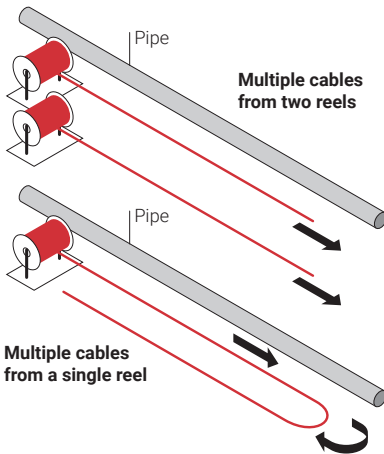
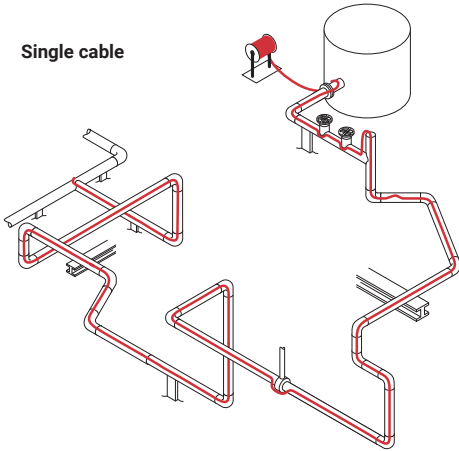

3

Heating Cable Installation

Heating cable paying out tips:

- Use a reel holder that pays out smoothly with little tension. If heating cable snags, stop pulling.
- Keep the heating cable strung loosely but close to the pipe being traced to avoid interference with supports and equipment.
- Meter marks on the heating cable can be used to determine heater length.
- Protect all heating cable ends from moisture, contamination, and mechanical damage.

When paying out the heating cable, AVOID:

- Sharp edges
- Excessive pulling force or jerking
- Kinking and crushing
- Walking on it, or running over it with equipment

⚠ WARNING: Fire and Shock Hazard. Do not install damaged cable. Components and cable ends must be kept dry before and during installation.

Positioning heating cables

If possible, position the heating cable on the lower section of the pipe, at the 4 and 8 o'clock positions, as shown below, to protect it from damage.

One heating cable

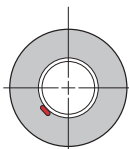

Two heating cables

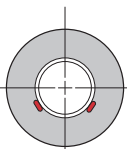

Attachment tapes

Suitable for use with one of the following nVent RAYCHEM attachment tapes to secure the heating cable on the the pipe: GT-66 or GS-54 fiberglass tape, or AT-180 aluminum tape.

3

Heating Cable Installation

GT-66 fiberglass tape

- General purpose tape for installation at 40°F (5°C) and above

GS-54 fiberglass tape

- Special application tape for stainless steel pipes
- For installations at -40°F (-40°C) and above

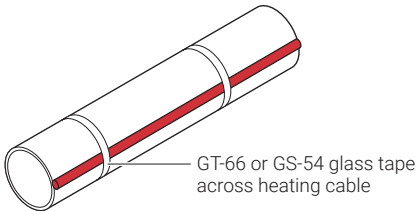

AT-180 aluminum tape

- Heat-transfer tape for plastic pipes, pump bodies, and odd-shaped equipment
- Install above 32°F (0°C)
- Tape lengthwise over the heating cable as required by the design

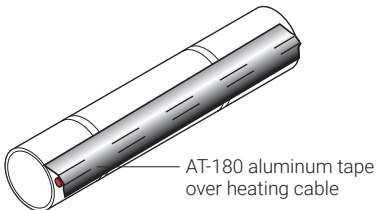

⚠ WARNING: Fire and Shock Hazard. Do not use metal attachments such as pipe straps or tie wire. Do not use vinyl-based electrical or duct tape. Use only nVent RAYCHEM approved tapes.

3

Heating Cable Installation

Attaching the heating cable

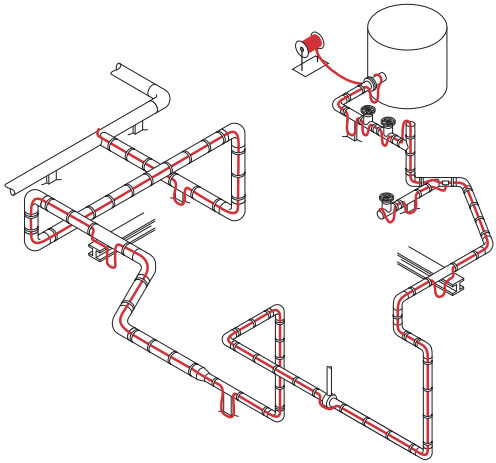

Starting from the end opposite the reel, tape the heating cable on the pipe at every foot, as shown in the figure above. If aluminum tape is used, apply it over the entire length of the heating cable after the cable has been secured with glass tape. Work back to the reel. Leave extra heating cable at the power connection, at all sides of splices and tees and at the end seal to allow for future servicing.

Allow a loop of extra cable for each heat sink, such as pipe supports, valves, flanges, and instruments, as detailed by the design. Refer to "Typical installation examples" on page 16 for attaching heating cable to heat sinks.

Install heating cable components immediately after attaching the heating cable. If immediate installation is not possible, protect the heating cable ends from moisture.

3

Heating Cable Installation

Multiple cables and spiraling

There are two situations where multiple heating cable runs may be required:

- **Redundant heat-tracing runs** are used in situations where a backup is required. Each run should be installed per the design specifications.
- **Double or multiple heat-tracing runs** are used when a single heat-tracing run alone cannot compensate for larger heat losses. Double heat-tracing runs should have extra heating cable installed at heat sinks, as called out in the design. It is recommended to supply the extra heating cable at heat sinks alternately from both runs in order to balance out both circuit lengths.

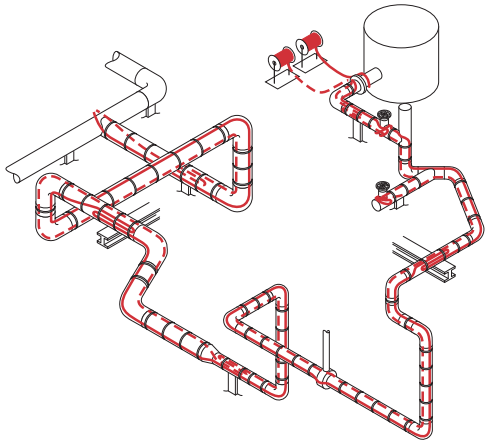

Spiral tracing

When the design calls for spiraling, begin by suspending a loop at every 10-foot pipe section. To determine the loop length, obtain a spiral factor from the design and multiply by 10. For example, if the spiral factor of 1.3 is called for, leave a 13-foot loop of heating cable at every 10-foot section of pipe. Attach the loop to the pipe at each interval using the appropriate nVent RAYCHEM attachment tape.

3

Heating Cable Installation

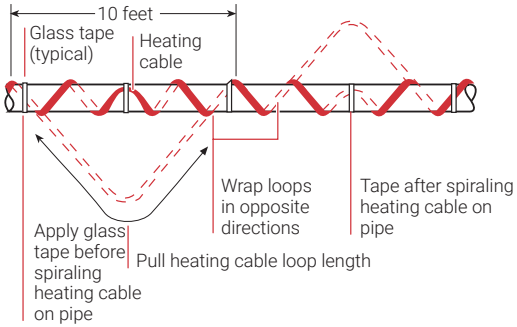

Bending the cable

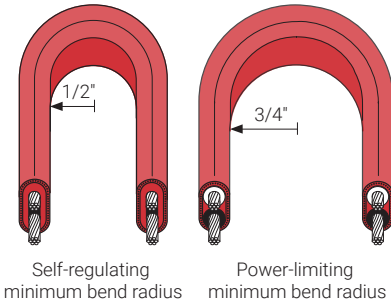

When positioning the heating cable on the pipe, do not bend tighter than 1/2" for self-regulating cables and 3/4" for power-limiting cables.

3

Heating Cable Installation

The heating cable does not bend easily in the flat plane. Do not force such a bend, as the heating cable may be damaged.



Crossing the cable

Self-Regulating cables, BTV, HBTV, QTVR, HQTV, HTV, XTV, HXTV, KTV allow for multiple overlapping of the heating cable.

Power-Limiting cable, VPL, allows for a single overlap of the heating cable per zone.

For VPL heating cable only:

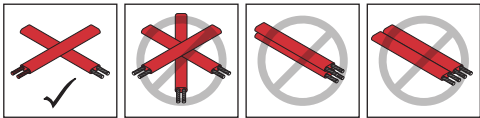

Cutting the cable

Cut the heating cable to length after it is attached to the pipe.

Heating cable can be cut to length without affecting the heat output per foot.

3

Heating Cable Installation

Typical installation examples

Wrap pipe fittings, equipment, and supports as shown in the following examples to properly compensate for higher heat-loss at heat sinks and to allow easy access for maintenance. The exact amount of heating cable needed is determined in the design.

Valve

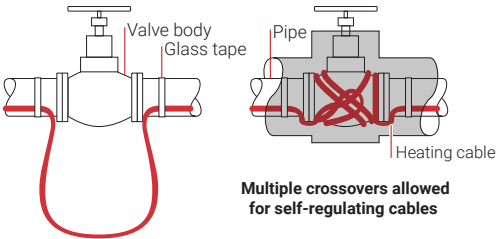

Note: Cable loop length varies depending on heat loss.

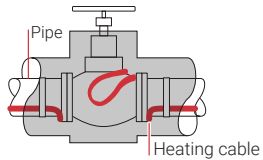

Flange

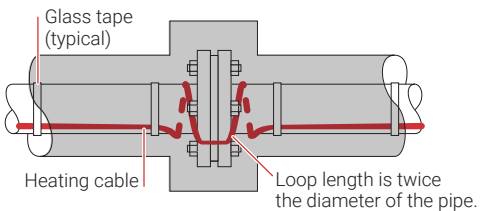

3

Heating Cable Installation

Pipe support shoe

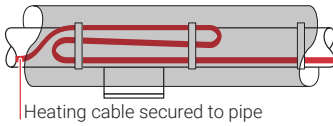
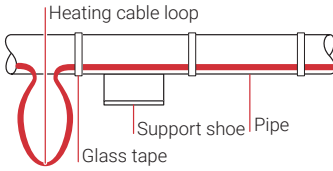

Elbow

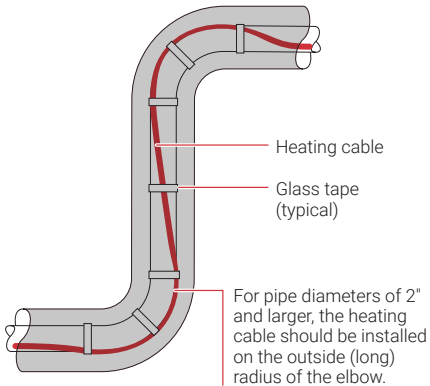

3

Heating Cable Installation

Pressure gauge

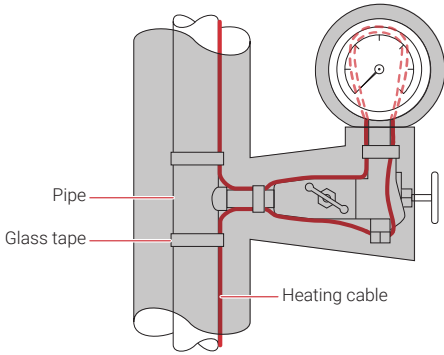

Split case centrifugal pump

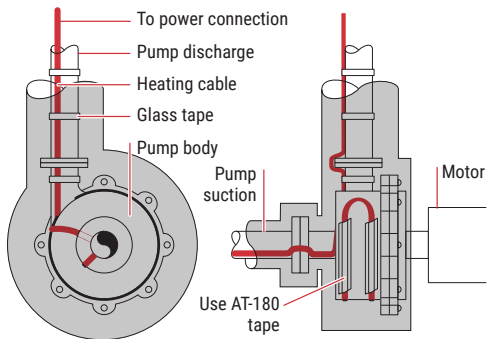

3

Heating Cable Installation

Pipe hanger

No additional heating cable is required for pipe hangers unless called for in the design specification, then use loop length specified.

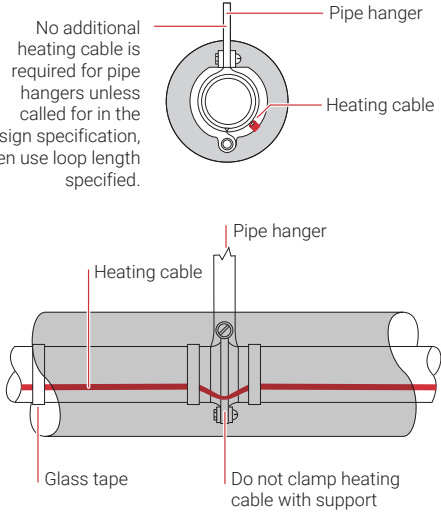

4

Heating Cable Components

4.1

General Component Information

nVent RAYCHEM components must be used with nVent RAYCHEM self-regulating and power-limiting heating cables. A complete circuit requires a power connection and an end seal. Splices and tees are used as needed.

Use the Industrial Product Selection and Design Guide or TraceCalc Pro to select appropriate components.

Installation instructions are included with the component kit. Steps for preparing the heating cable and connecting to components must be followed.

nVent RAYCHEM self-regulating and power-limiting heating cables are parallel circuit design. Do not twist the conductors together as this will result in a short circuit.

Component Installation Tips

- Connection kits should be mounted on top of the pipe when practical. Electrical conduit leading to power connection kits should have low-point drains to keep condensation from accumulating in the conduit. All heating cable connections must be mounted above grade level.
- Special adapters are available for mounting on small pipes. Be sure to use these adapters if installing cables on pipes of 1 inch O.D. or less.
- Be sure to leave a service loop at all components for future maintenance, except when temperature-sensitive fluids are involved or when the pipe is smaller than 1 inch.
- Locate junction boxes for easy access, but not where they may be exposed to mechanical abuse.
- Heating cables must be installed over, not under, pipe straps used to secure components.
- For VPL, cut cable 12" (30 cm) from last active node (indentation) to be sure an inactive zone is used to enter the component. Refer to component installation instructions.

4

Heating Cable Components

- All power connections, splices, tees, and end seals in a Division 1 location must use the HAK-C-100 connection kit and an HAK-JB3-100 or a Division 1 Nationally Recognized Testing Lab (NRTL) approved junction box.

 **WARNING:** The black heating cable core and fibers are electrically conductive and can short. They must be properly insulated and kept dry. Damaged bus wires can overheat or short. Do not break bus wire strands when stripping the heating cable.

Specific Conditions of Use

The following limiting temperatures for the internal components of power connections, end seals and splices shall not be exceeded:

+260°C for the E-40 and S-40

+150°C for the S-150 and E-150

+151°C for the E-100, E-100-L and JBS-100

+155°C for the JBM-100 and T-100

The E-100, E-100-L, JBM-100, JBM-100-L, JBS-100, JBS-100-L and T-100 have limiting temperatures based on an internal component in these accessories. When located on a pipe or other work piece surface, a maximum pipe temperature of 250°C will not cause the limiting temperatures of 151°C or 155°C to be exceeded.

The end seals, splices and power connections have the following associated ambient temperatures:

-60°C to +56°C for the E-40 and S-40

-55°C to +56°C for the T-100, JBM-100, JBS-100, JBU-100 and E-100

-40°C to +40°C for the JBS-100-L, JBM-100-L, and JBU-100-L

-55°C to +55°C for the S-150 and E-150

-40°C to +40°C for the E-100-L

The assembly of glands, splices and end terminations shall be carried out in accordance with the manufacturer's instructions.

4

Heating Cable Components

- The heating element supply circuit must include an electrical protection device in conformity with Clause 4.4 of IEC 60079-30-1.
- The minimum installation temperature of the heating cables is -60°C . The minimum bending radii at specific temperatures are shown on the next pages of this document.
- The supply to the heating unit must be terminated in a suitably certified terminal enclosure.

nVent RAYCHEM Components for Nonhazardous, CID2 and Zone 1 Hazardous Locations

Power Connection

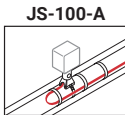
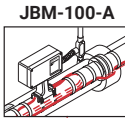

JBS-100-A



Splice

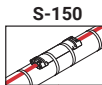

T-100



Tee



T-100



End Seal



E-100-L-A



E-100-A



PMKG-LE



PMKG-LE, PMKG-LT, PMKG-LS are only approved for use with BTV and QTVR heating cables.

S-150, E-150 are only approved with BTV, QTVR, XTV, KTV heating cables.

4

Heating Cable Components

HTV heating cables and components are c FM us approved for CID2 (zone 2) Groups A, B, C D.

nVent RAYCHEM Components for CID1 Hazardous Locations Groups B, C, D

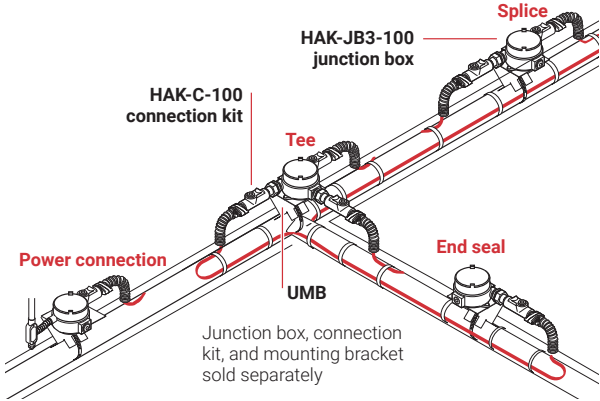

WARNING: Fire and Shock Hazard.
nVent RAYCHEM brand specified components must be used. Do not substitute parts or use vinyl electrical tape.

5

Control and Monitoring

nVent RAYCHEM control and monitoring products are designed for use with Self-Regulating and Power-Limiting heat-tracing systems. Thermostats, controllers and control and monitoring systems are available. Compare features of these products in the table below. For additional information on each product, refer to the Industrial Product Selection and Design Guide or contact your nVent representative.

Refer to the installation instructions supplied with control and monitoring products. Control and Monitoring systems may require installation by a certified electrician.

nVent Control and Monitoring Products

	THERMOSTATS		CONTROLLERS			
	AMC-F5 AMC-1B AMC-2B-2 E507S-LS	AMC-F5 AMC-1B AMC-2B-2 E507S-LS	nVent RAYCHEM Series 1, 2			
	AMC-F5 AMC-1A AMC-1H	E507S-2LS-2 Raystat-EX-03-A ETS-05	Elexant 4010i & 4020i	920	NGC-30	NGC-40
Control						
Ambient sensing	■		●	●	●	●
Line-sensing		■	●	●	●	●
PASC			●	●	●	●
Monitoring						
Ambient temperature			●	●	●	●
Pipe temperature			●	●	●	●
Ground fault			●	●	●	●
Current			●	●	●	●
Location						
Local	■	■	●	●	●	●
Remote			●	●	●	●
Hazardous	AMC-1H	E507S, ETS-05	●	●	●	●

5

Control and Monitoring

nVent Control and Monitoring Products

THERMOSTATS		CONTROLLERS			
	AMC-F5				
	AMC-1B				
	AMC-2B-2				
	E507S-LS	nVent RAYCHEM Series ^{1, 2}			
AMC-F5	E507S-2LS-2	Elexant			
AMC-1A	Raystat-EX-03-A	4010i & 4020i	920	NGC-30	NGC-40
AMC-1H	ETS-05				

Communications

Local display		•	•	•	•
Remote display		•	•	•	•
Network to DCS		•	•	•	•

¹ nVent RAYCHEM controllers used in CID1 areas require the use of appropriate hazardous area enclosures or Z-purge systems.

² 480-V VPL must use nVent RAYCHEM Elexant 4020i, 920, NGC-30, or NGC-40 controllers only.

6

Thermal Insulation

6.1 Pre-Insulation Checks

Visually inspect the heating cable and components for correct installation and damage. Damaged cable must be replaced.

Perform insulation resistance testing, known as a Megger test (refer to Section 9), prior to covering the pipe with thermal insulation.

6.2 Insulation Installation Hints

- Insulation must be properly installed and kept dry.
- Check insulation type and thickness against the design specification.
- To minimize potential heating cable damage, insulate as soon as possible after tracing.
- Check that pipe fittings, wall penetrations, and other irregular areas have been completely insulated.
- When installing cladding, be sure drills, screws, and sharp edges do not damage the heating cable.
- To weatherproof the insulation, seal around all fixtures that extend through the cladding. Check around valve stems, support brackets, and thermostat capillaries.

6.3 Marking

Apply “Electric Traced” labels on outside of the cladding at 10-foot intervals on alternate sides to indicate presence of electric cables.

Other labels, which identify the location of splices, tees, and end connections installed beneath the thermal insulation, are supplied with those components and must also be used.

6.4 Post-Insulation Testing

After the insulation is complete, perform an insulation resistance test on each circuit to confirm that the cable has not been damaged (refer to Section 9).

 **WARNING:** Use only fire-resistant insulation, such as fiberglass, mineral wool, or calcium silicate.

7

Power Supply and Electrical Protection

7.1 Voltage Rating

Verify that the source voltage corresponds to the heating cable rating printed on the cable jacket and specified by the design.

7.2 Electrical Loading

Overcurrent devices are selected according to the heating cable type, source voltage, and circuit length to allow start-up at the designed ambient temperatures. The design specifies the size and type of overcurrent device.

7.3 Ground-Fault Protection

If the heating cable is improperly installed, or physically damaged to the point that water contacts the bus wires, sustained arcing or fire could result. If arcing does occur, the fault current may be too low to trip conventional circuit breakers.

nVent, the U.S. National Electrical Code, and the Canadian Electrical Code require both ground-fault protection of equipment and a grounded metallic covering on all heating cables.

All nVent RAYCHEM products meet the metallic covering requirement. The electrically conductive covering of trace heater shall be connected to a suitable grounding terminal. Following are some of the ground-fault breakers that satisfy this equipment protection requirement: Square D Type GFPD EHB-EPD (277 Vac), Cutler Hammer (Westinghouse) Type QBGFEP.

480-V VPL must use nVent RAYCHEM 920, Elexant 4020i, NGC-40 or NGC-30 controllers only, which provide ground-fault protection at 480 volts.

 **WARNING:** To minimize the danger of fire from sustained electrical arcing if the heating cable is damaged or improperly installed, and to comply with nVent requirements, agency certifications, and national electrical codes, ground-fault equipment protection must be used on each heating cable branch circuit. Arcing may not be stopped by conventional circuit breakers.

 **WARNING:** Disconnect all power before making connections to the heating cable.

8

Commissioning and Preventive Maintenance

nVent requires a series of tests be performed on the heat-tracing system upon commissioning. These tests are also recommended at regular intervals for preventive maintenance. Results must be recorded and maintained for the life of the system, utilizing the "Installation and Inspection Record" (refer to Section 11).

Caution: Consult the trace heating system documentation prior to maintenance/ repair/ modification

Caution: After maintenance/ repair/ modification, test the operation of the ground-fault device of each affected circuit.

Caution: In the event of an ground fault or over current interruption, the device shall not be reset until the cause of the trip has been investigated by qualified personnel.

8.1

Tests

A brief description of each test is found below. Detailed test procedures are found in Section 9.

Visual inspection

Visually inspect the pipe, insulation, and connections to the heating cable for physical damage. Check that no moisture is present, electrical connections are tight and grounded, insulation is dry and sealed, and control and monitoring systems are operational and properly set. Damaged heating cable must be replaced.

Insulation Resistance

Insulation Resistance (IR) testing is used to verify the integrity of the heating cable inner and outer jackets. IR testing is analogous to pressure testing a pipe and detects if a hole exists in the jacket. IR testing can also be used to isolate the damage to a single run of heating cable. Fault location can be used to further locate damage.

8

Commissioning and Preventive Maintenance

Power check

The heating cable power per foot (meter) is calculated by dividing the total wattage by the total length of a circuit. The current, voltage, operation temperature, and length must be known. Circuit length can be determined from “as built” drawings, meter marks on cable, or the capacitance test.

$$\text{Power (w/ft or m)} = \frac{\text{Volts (Vac)} \times \text{Current (A)}}{\text{Length (ft or m)}}$$

The watts per foot (meter) can be compared to the heating cable output indicated on the product data sheet at the temperature of operation. This gives a good indication of heating cable performance.

Ground-fault test

Test all ground-fault breakers per manufacturer’s instructions.

8.2

Preventive Maintenance

Recommended maintenance for nVent heat-tracing systems consists of performing the commissioning tests on a regular basis. Procedures for these tests are described in Section 9. Systems should be checked before each winter.

If the heat-tracing system fails any of the tests, refer to Section 10 for troubleshooting assistance. Make the necessary repairs and replace any damaged cable immediately.

De-energize all circuits before installation or servicing.

Protect the heating cable from mechanical or thermal damage during maintenance work.

The recommended cable installation methods allow for extra cable at all pipe fixtures (such as valves, pumps, and pressure gauges) that are likely to incur maintenance work.

Maintenance records

The “Installation and Inspection Record,” (refer to Section 11), should be filled out during all maintenance and repair work, and kept for future reference.

8

Commissioning and Preventive Maintenance

Repairs

Use only nVent RAYCHEM cable and components when replacing any damaged heating cable.

Replace the thermal insulation to original condition or replace with new insulation, if damaged.

Retest the system after repairs.



WARNING: Damage to cables or components can cause sustained electrical arcing or fire. Do not attempt to repair damaged heating cable. Do not energize cables that have been damaged by fire. Replace damaged cable at once by removing the entire damaged section and splicing in a new length using the appropriate nVent RAYCHEM splice kits. Do not reuse grommets. Use new grommets whenever the heating cable has been pulled out of the components.

9

Test Procedures

9.1 Visual Inspection

- Check inside heating cable components for proper installation, overheating, corrosion, moisture, and loose connections.
- Check the electrical connections to ensure that ground and bus wires are insulated over their full length.
- Check for damaged or wet thermal insulation; damaged, missing or cracked lagging and weather-proofing.
- Check that end seals, splices, and tees are properly labeled on insulation cladding.
- Check control and monitoring system for moisture, corrosion, set point, switch operation and capillary damage.

9.2 Insulation Resistance (Megger) Test

Frequency

Insulation resistance testing is recommended at five stages during the installation process and as part of regularly scheduled maintenance.

- Before installing the cable
- Before installing components
- Before installing the thermal insulation
- After installing the thermal insulation
- Prior to initial start-up (commissioning)
- As part of the regular system inspection
- After any maintenance or repair work

Procedure

Insulation resistance testing (using a megohmmeter) should be conducted at three voltages; 500, 1000, and 2500 Vdc. Significant problems may not be detected if testing is done only at 500 and 1000 volts.

First measure the resistance between the heating cable bus wires and the braid (Test A) then measure the insulation resistance between the braid and the metal pipe (Test B). Do not allow test leads to touch junction box, which can cause inaccurate readings.

9

Test Procedures

1. De-energize the circuit.
2. Disconnect the thermostat or controller if installed.
3. Disconnect bus wires from terminal block, if installed.
4. Set test voltage at 0 Vdc.
5. Connect the negative (-) lead to the heating cable metallic braid.
6. Connect the positive (+) lead to both heating cable bus wires simultaneously.
7. Turn on the megohmmeter and set the voltage to 500 Vdc; apply the voltage for 1 minute. The meter needle should stop moving. Rapid deflection indicates a short. Record the insulation resistance value in the Inspection Record.
8. Repeat Steps 4–7 at 1000 and 2500 Vdc.
9. Turn off the megohmmeter.
10. If the megohmmeter does not self-discharge, discharge phase connection to ground with a suitable grounding rod. Disconnect the megohmmeter.
11. Repeat this test between braid and pipe.
12. Reconnect bus wires to terminal block.
13. Reconnect the thermostat.



Important: System checkout and regular maintenance procedures require that insulation resistance testing be performed from the distribution panel unless a control and monitoring system is in use. If no control system is being used, remove both power feed wires from the breaker and proceed as if testing heating cable bus wires. If a control and monitoring system is being used, remove the control equipment from the circuit and conduct the test directly from the heating cable.



WARNING: Fire hazard in hazardous locations. The insulation resistance test can produce sparks. Be sure there are no flammable vapors in the area before performing this test.

9

Test Procedures

Insulation resistance criteria

A clean, dry, properly installed circuit should measure thousands of megohms, regardless of the heating cable length or measuring voltage (0–2500 Vdc). The following criteria are provided to assist in determining the acceptability of an installation where optimum conditions may not apply.

All insulation resistance values, including upon completion of maintenance / repair / modification, should be greater than 1000 megohms. If the reading is lower, consult Section 10, Troubleshooting Guide.



Important: Insulation resistance values for Test A and B; for any particular circuit, should not vary more than 25 percent as a function of measuring voltage. Greater variances may indicate a problem with your heat-tracing system; confirm proper installation and/or contact nVent for assistance.

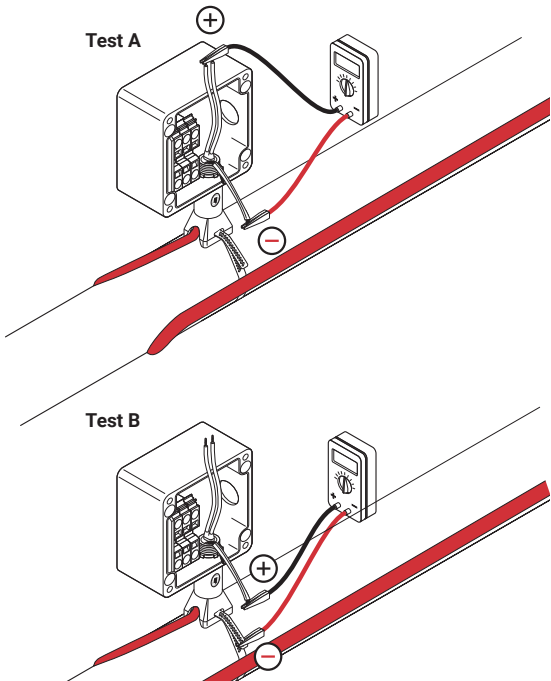

9

Test Procedures

9.3 Continuity check

Continuity of the heating cables installed should be checked prior to energizing the system in order to prevent controller damage.

Measuring across the 2 bus-wires, measure the overall resistance of the cable.

If the resistance is less than 3 ohms, do not energize the circuit, as this could indicate a short circuit within your heat tracing length.

A normally functioning heating cable would typically have a resistance between 3 and 100 Ohms.

9.4 Power Check

The power output of Self-Regulating and Power-Limiting cable is temperature-sensitive and requires the following special procedure to determine its value.

1. Power the heating cable and allow it to stabilize for 10 minutes, then measure current and voltage at the junction box. If a thermostat or controller is used, refer to details below.
2. Check the pipe temperature under the thermal insulation at several locations.
3. Calculate the power (watts/ft) of the heating cable by multiplying the current by the input voltage and dividing by the actual circuit length.

$$\text{Power (w/ft or m)} = \frac{\text{Volts (Vac)} \times \text{Current (A)}}{\text{Length (ft or m)}}$$

Ambient-sensing controlled systems

If the actual ambient temperature is higher than the desired thermostat setting, turn the thermostat setting up high enough to turn on the system, or (with some models) manually set the selector switch to the ON position.

- Turn on the main circuit breaker.
- Turn on the branch circuit breakers.
- After a minimum of ten minutes, measure the voltage, amperage, ambient temperature, and pipe temperature for each circuit and record the values in the "Installation and Inspection

9

Test Procedures

Record" (refer to Section 11). This information is needed for future maintenance and troubleshooting.

- When the system is completely checked out, reset the thermostat to the proper temperature.

Line-sensing controlled systems

Set the thermostat to the desired control temperature, or to a setting high enough to turn the circuit on if the pipe temperature is above the control temperature.

- Turn on the main circuit breaker.
- Turn on the branch circuit breakers.
- Allow the system to reach the control point. This may take up to four hours for most circuits. Large, liquid-filled pipes may take longer.
- Measure the voltage, amperage, and pipe temperature for each circuit and record the values in the "Installation and Inspection Record" (refer to Section 11). This information is needed for future maintenance and troubleshooting.
- When the system is completely checked out, reset the thermostat to the proper temperature.

Control and monitoring systems

Refer to the installation instructions supplied with the product for commissioning tests and records.

9.5 Fault Location Tests

Fault location

There are three methods used for finding a fault within a section of heating cable: the ratio method, 1/R method, and the capacitance method. The capacitance method can also be used to determine total heating cable length.

Ratio test method

a.) To locate bus wire short:

The ratio method uses resistance measurements taken at each end of the heating cable to approximate the location of a bus wire short.

9

Test Procedures

A shorted heating cable could result in a tripped circuit breaker or a cold section of pipe.

Measure the bus-to-bus conductor resistance from the front end (measurement A) and the back end (measurement B) of the suspected section.

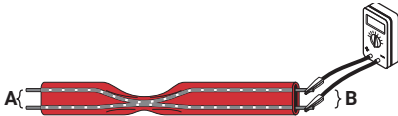

The approximate location of the bus wire short, expressed as a percentage of the heating cable length from the front end, is:

$$\text{Fault location: } D = \frac{A}{A + B} \times 100$$

Example: A = 1.2 ohms
 B = 1.8 ohms

$$\text{Fault location: } D = 1.2 / (1.2 + 1.8) \times 100 \\ = 40\%$$

The fault is located 40% along the circuit as measured from the front end (A).

b.) To locate low resistance ground fault:

To locate a low resistance ground fault, **measure resistance between bus and braid.**



The approximate location of the fault, expressed as a percentage of the heating cable length from the front end (A), is:

$$\text{Fault location: } D = \frac{A}{A + B} \times 100$$

9

Test Procedures

Example: A = 0.6 ohms
 B = 0.9 ohms

Fault location: $D = 0.6 / (0.6 + 0.9) \times 100$
 = 40%

The fault is located 40% along the circuit as measured from the front end (A).

c.) To locate severed section:

This method uses the core resistance of the heating cable to approximate the location of a fault when the heating cable has been severed and the bus wires have not been shorted together. A severed cable may result in a cold section of pipe and many not trip the circuit breaker.



Measure the bus-to-bus heating cable resistance from the front end (measurement A) and the back end (measurement B) of the suspect section.

The approximate location of the fault, expressed as a percentage of the heating cable length from the front end (A) is:

Fault location: $D = \frac{1/A}{(1/A + 1/B)} \times 100$

Example: A = 100 ohms
 B = 25 ohms

Fault location: $D = (1/100) / (1/100 + 1/25) \times 100$
 = 20%

The fault is located 20% from the front end (A) of the circuit.

9

Test Procedures

Capacitance test method

This method uses capacitance measurement (nF) to approximate the location of a fault where the heating cable has been severed. It also gives an estimate of total heating cable length in a non-severed circuit. This reading must be taken at the power connection and will only work when the heating cable has passed IR testing. This information is used to calculate the heating cable output per linear foot or to determine if the maximum length has been exceeded.

Record the capacitance reading from one end of the heating cable. The capacitance reading should be measured between both bus wires twisted together (positive lead) and the braid (negative lead).

Multiply the measured capacitance with the heating cable's capacitance factor as listed in the following table.

Example:

20XTV2-CT

Recorded capacitance = 16.2 nF

Capacitance factor = 10.1 ft/nF

Fault location = 16.2 nF x 10.1 ft/nF

= 164 ft (50 m)

from reading location

As an alternative, capacitance values from both the front and back end can be used. The ratio of one capacitance value taken from one end (A) divided by the sum of both A and B (A + B) and then multiplied by 100 yields the distance from the first end, expressed as a percentage of the heating circuit length.

9

Test Procedures

Heating cable capacitance factors (ft/nF)

Cable catalog number	Capacitance factor	Cable catalog number	Capacitance factor
3BTV1-CR	7.5	20XTV1-CT-T2	9.3
3BTV2-CT		20XTV2-CT-T2	10.1
3BTV1-CR		5KTV1-CT	10.8
3BTV2-CT		5KTV2-CT	11.1
5BTV1-CR	7.5	8KTV1-CT	10.3
5BTV2-CT		8KTV2-CT	10.5
5BTV1-CR		15KTV1-CT	9.7
5BTV2-CT		15KTV2-CT	9.9
8BTV1-CR	5.5	20KTV1-CT	9.3
8BTV2-CT		20KTV2-CT	10.1
8BTV1-CR		All VPL-CT	9.4
8BTV2-CT		3HTV1-CT	10.5
10BTV1-CR	5.5	3HTV2-CT	11.5
10BTV2-CT		5HTV1-CT	10.5
10BTV1-CR		5HTV2-CT	11.1
10BTV2-CT		8HTV1-CT	9.2
10QTVR1-CT	4.7	8HTV2-CT	11.1
10QTVR2-CT		10HTV1-CT	9.2
15QTVR2-CT		10HTV2-CT	10.5
15QTVR1-CT	3.3	12HTV1-CT	9.6
20QTVR1-CT		12HTV2-CT	10.3
20QTVR2-CT		15HTV1-CT	9.3
5XTV1-CT-T3	10.8	15HTV2-CT	9.8
5XTV2-CT-T3	11.1	20HTV1-CT	8.7
10XTV1-CT-T3	10.3	20HTV2-CT	9.7
10XTV2-CT-T3	10.7		
15XTV1-CT-T3	9.7		
15XTV2-CT-T3	9.9		

10

Troubleshooting Guide

Symptom

Low or inconsistent insulation resistance

Probable Causes

Nicks or cuts in the heating cable.

Short between the braid and heating cable core or the braid and pipe.

Arcing due to damaged heating cable insulation.

Moisture present in the components.

Test leads touching the junction box.

High pipe temperature may cause low IR reading.

Reference tests:

Symptom

Circuit breaker trips

Probable Causes

Circuit breaker is undersized.

Start-up at too low a temperature. Connections and/or splices are shorting out.

Physical damage to heating cable is causing a direct short.

Bus wires are connected at the end.

Nick or cut exists in heating cable or power feed wire with moisture present or moisture in connections.

GFPD is undersized (5 mA used instead of 30 mA) or miswired.

Reference tests:

Corrective Action

Check power, splice, tee, and end connections for cuts, improper stripping distances, and signs of moisture. If heating cable is not yet insulated, visually inspect the entire length for damage, especially at elbows and flanges and around valves. If the system is insulated, disconnect heating cable section between power kits, splices, etc., and test again to isolate damaged section.

Replace damaged heating cable sections and restrip any improper or damaged connections.

If moisture is present, dry out the connections and retest. Be sure all conduit entries are sealed, and that condensate in conduit cannot enter power connection boxes. If heating cable core or bus wires are exposed to large quantities of water, replace the heating cable. (Drying the heating cable is not sufficient, as the power output of the heating cable can be significantly reduced.)

Clear the test leads from junction box and restart.

Retest at ambient, if necessary.

Insulation Resistance Test, Visual Inspection

Corrective Action

Recheck the design for startup temperature and current loads. Do not exceed the maximum circuit length for heating cable used. Check to see if existing power wire sizing is compatible with circuit breaker. Replace the circuit breaker if defective or improperly sized. Visually inspect the power connections, splices, and end seals for proper installation; correct as necessary.

Check for visual indications of damage around the valves, pump, and any area where there may have been maintenance work. Look for crushed or damaged insulation lagging along the pipe. Replace damaged sections of heating cable.

Check the end seal to ensure that bus wires are properly terminated per installation instructions. If a dead short is found, the heating cable may have been permanently damaged by excessive current and may need to be replaced.

Replace the heating cable, as necessary. Dry out and reseal the connections and splices. Using a megohmmeter, retest insulation resistance.

Replace undersized GFPD with 30 mA GFPD. Check the GFPD wiring instructions.

Insulation Resistance Test, Fault Location Test, Visual Inspection

10

Troubleshooting Guide

Symptom

Probable Causes

Low pipe temperature

Insulation is wet, or missing.

Insufficient heating cable was used on valves, supports, and other heat sinks.

Thermostat was set incorrectly.

Improper thermal design used.

Improper voltage applied.

Thermocouple is not in contact with pipe.

Reference tests:

Symptom

Probable Causes

Low or no power output

Low or no input voltage applied.

The circuit is shorter than the design shows, due to splices or tees not being connected, or the heating cable having been severed.

Improper component connection causing a high-resistance connection.

Control thermostat is wired in normally open position.

Pipe is at an elevated temperature.

The heating cable has been exposed to excessive temperature, moisture or chemicals.

Reference tests:

Corrective Action

Remove wet insulation and replace with dry insulation, and secure it with proper weatherproofing.

Splice in additional heating cable but do not exceed maximum circuit length.

Reset the thermostat.

Contact your nVent representative to confirm the design and modify as recommended.

Reinstall the thermocouple on the pipe.

Power Check, Visual Inspection

Corrective Action

Repair the electrical supply lines and equipment.

Check the routing and length of heating cable (use "as built" drawings to reference actual pipe layout).

Connect all splices or tees. Locate and replace any damaged heating cables. Then recheck the power output.

Check for loose wiring connections and rewire if necessary.

Rewire the thermostat in the normally closed position.

Check the pipe temperature. Verify heater selection. Check the power output of the heating cable per the design vs. actual. Reduce pipe temperature if possible or contact your nVent representative to confirm design.

Replace damaged heating cable. Check the pipe temperature. Check the power output of heating cable.

Power Check, Fault Location Test, Visual Inspection

11

Installation and Inspection Records

nVent Heat-Tracing Installation and Inspection Record

Facility _____

Circuit number _____

Heating cable type _____

Circuit length _____

Commission

Inspection date:			
Visual Inspection			
Visual inspection inside connection boxes for signs of overheating, corrosion, moisture, loose connections and other problems.			
Proper electrical connection, ground, and bus wires insulated over full length.			
Damaged or wet thermal insulation; damaged, missing, cracked lagging or weather-proofing; gaps in caulking.			
Covered end seals, splices, and tees properly labeled on insulation cladding.			
Control and Monitoring system checked for moisture, corrosion, set point, switch operation, capillary damage, and protection.			
Insulation resistance (Megger) test		Ohms	
Test A	500 Vdc		
(bus to braid)	1000 Vdc		
	2500 Vdc		
Test B	500 Vdc		
(braid to pipe)	1000 Vdc		
	2500 Vdc		
Power check			
Circuit voltage			
Panel	(Vac)		
Circuit end*	(Vac)		
Circuit amps after 10 min	(Amps)		
Pipe temperature	(°F)		
Power = Volts x amps/ft	(watts/ft)		

* Commissioning only

	Ohms	Ohms	Ohms	Ohms

11

Installation and Inspection Records

nVent Heat-Tracing Installation and Inspection Record

Facility	_____
Circuit number	_____
Heating cable type	_____
Circuit length	_____

Commission

Inspection date:		
Visual Inspection		
Visual inspection inside connection boxes for signs of overheating, corrosion, moisture, loose connections and other problems.		
Proper electrical connection, ground, and bus wires insulated over full length.		
Damaged or wet thermal insulation; damaged, missing, cracked lagging or weather-proofing; gaps in caulking.		
Covered end seals, splices, and tees properly labeled on insulation cladding.		
Control and Monitoring system checked for moisture, corrosion, set point, switch operation, capillary damage, and protection.		
Insulation resistance (Megger) test	Ohms	
Test A	500 Vdc	
(bus to braid)	1000 Vdc	
	2500 Vdc	
Test B	500 Vdc	
(braid to pipe)	1000 Vdc	
	2500 Vdc	
Power check		
Circuit voltage		
Panel	(Vac)	
Circuit end*	(Vac)	
Circuit amps after 10 min	(Amps)	
Pipe temperature	(°F)	
Power = Volts x amps/ft	(watts/ft)	

* Commissioning only

	Ohms	Ohms	Ohms	Ohms

11

Installation and Inspection Records

FM Required Installation Record for Class I, Division 1, Hazardous Locations

To complete the FM approval process, this complete form must be returned to the nVent Customer Service Center (fax number (800) 527-5703)

Company name _____

Circuit ID no. _____

Area _____

Autoignition temp. (AIT): _____

Heater circuit

Heater type: _____

Supply voltage: _____

Maximum pipe temp: _____

Components

Power connection _____

Tee _____

Ground-fault equipment

Make and model: _____

Installation instructions

Correct components per manufacturer's specification: _____

Seal fittings opened and inspected (properly poured): _____

Ground-leakage device tested: _____

Insulation resistance testing

Use 2500 Vdc for Self-Regulating and Power-Limiting cables

Instrument used: _____

As measured on the pipe before insulation installed*

Insulation resistance between conductor and braid (Test A) _____

Insulation resistance between braid and pipe (Test B) _____

As measured after insulation installed*

Insulation resistance between conductor and braid (Test A) _____

Insulation resistance between braid and pipe (Test B) _____

* Minimum insulation resistance must be 1000 MΩ

Circuit ready to commission

Prepared by _____

Approved by _____

Purchase order no. _____

Ref. drawing(s) _____

Group classification: _____

Circuit length: _____

Temp ID (T-rating) _____

Splice: _____

End seal: _____

Device trip level: _____

Calibration date:

Test value	Date	Initials
-------------------	-------------	-----------------

Test value	Date	Initials
-------------------	-------------	-----------------

Company	Date
---------	------

Company	Date
---------	------

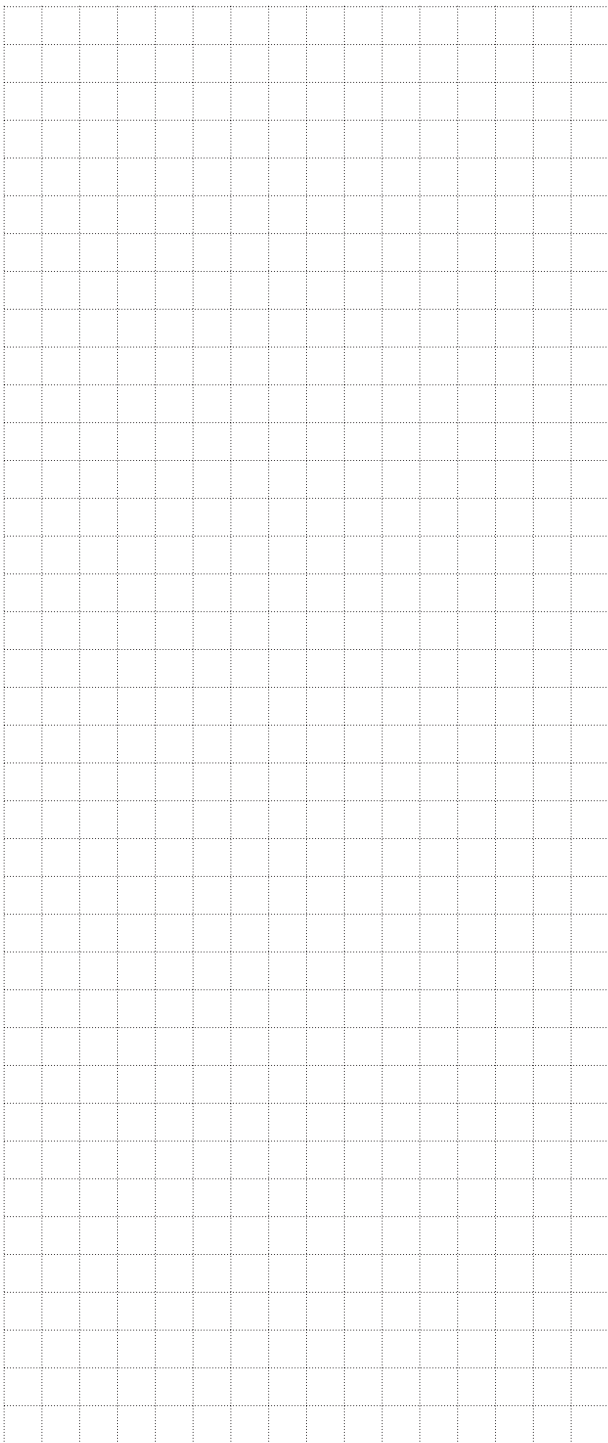

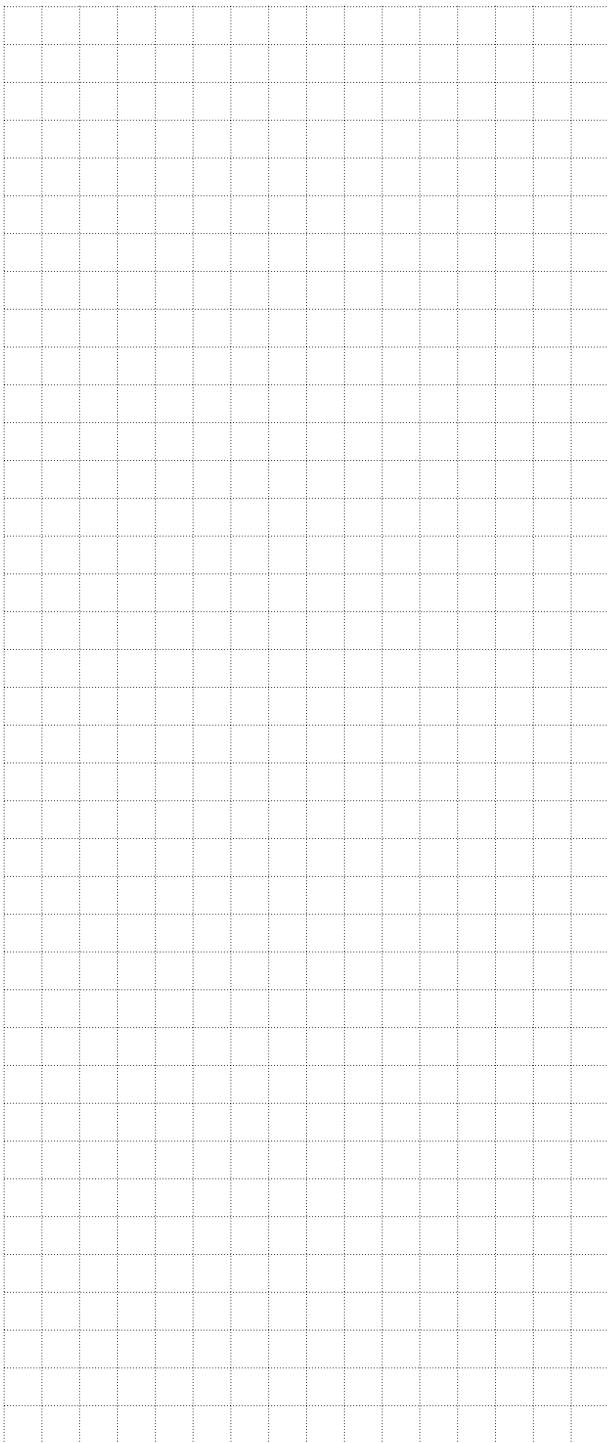

North America

Tel +1.800.545.6258
Fax +1.800.527.5703
thermal.info@nVent.com

Asia Pacific

Tel +86.21.2412.1688
Fax +86.21.5426.3167
cn.thermal.info@nVent.com

Europe, Middle East, Africa

Tel +32.16.213.511
Fax +32.16.213.604
thermal.info@nVent.com

Latin America

Tel +1.713.868.4800
Fax +1.713.868.2333
thermal.info@nVent.com



nVent.com/RAYCHEM

©2021 nVent. All nVent marks and logos are owned or licensed by nVent Services GmbH or its affiliates. All other trademarks are the property of their respective owners. nVent reserves the right to change specifications without notice.

RAYCHEM-IM-H57274-SelfRegPowerLimHeatTrac-EN-2112