



CONNECT AND PROTECT

Our Innovations

Supplement to nVent HOFFMAN Product Catalogue



HOFFMAN



Table of contents

Floor Standing Enclosures

- Quick fixation baying brackets 4
- Profile system 6
- Side panels fixation with new patented retainer 8
- Mounting filler plate 10
- Floor standing combinable enclosure with IP 66 rating 12
- Outdoor combinable floor standing enclosure 14
- Flange mount disconnect enclosure 16
- Interlocking system 18
- Outer mounting profile 20
- Swing frame retainer 22
- Mounting plate brackets for mounting from the rear 24

Wall Mounted Enclosures

- New locking system 26
- 180° hinges 28
- Depth interior profile 30
- Door wheel for MAS 32

Thermal management

- Slim Fit indoor air conditioner 34
- T-Series outdoor air conditioner 36
- SpectraCool with Advanced Corrosion Protection 38
- Thermoelectric coolers 40

Others

- ZONEX enclosures, EXE 42
- Operator interface control enclosure, OICE 44
- Swing arm systems 46
- Earthing portfolio 38
- LED light 50
- Cage nuts 52
- Unibody enclosures, SSFS 54

Floor Standing Enclosures

Quick fixation baying brackets

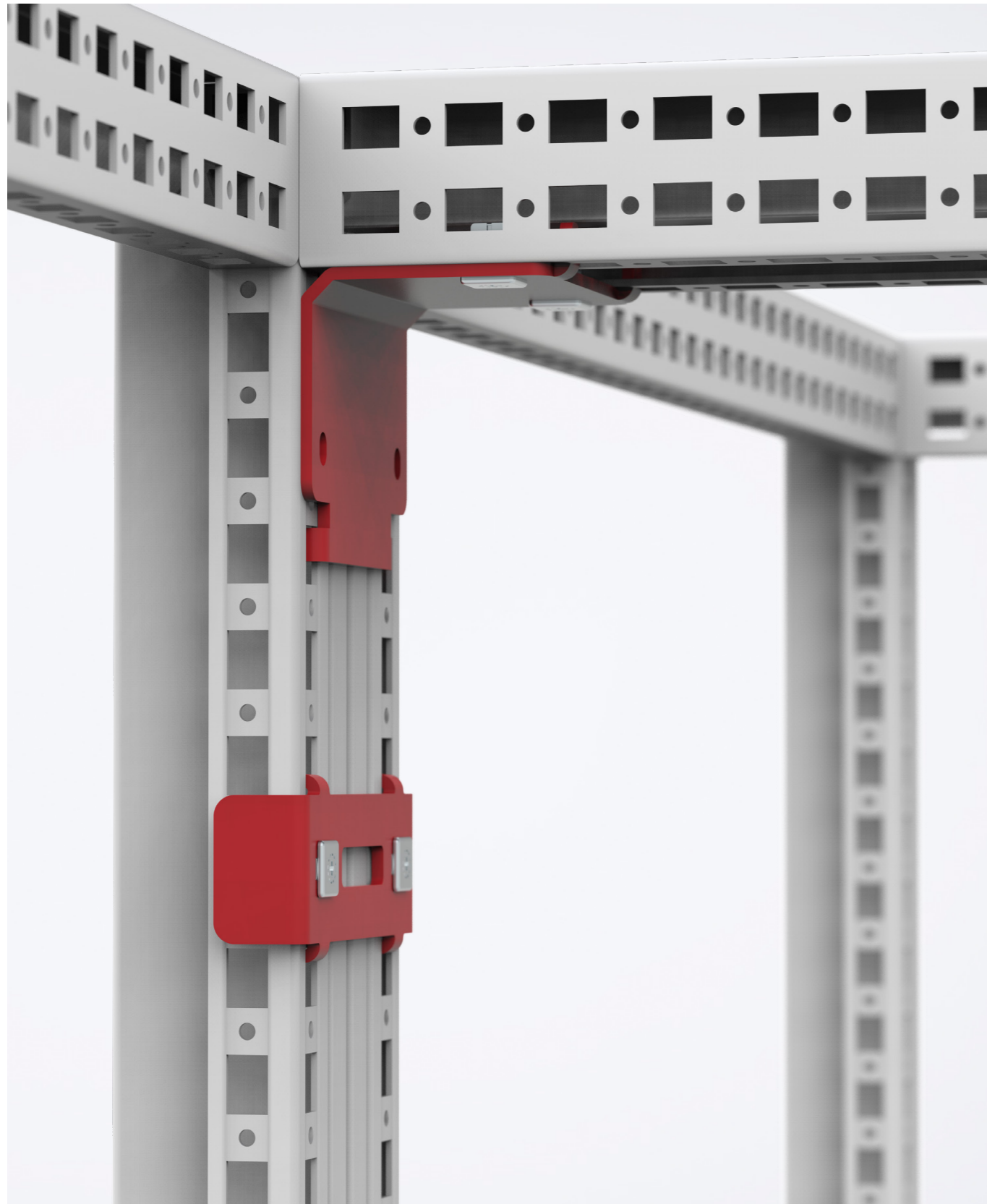

Customer benefits

- Fast installation of bayed enclosure solutions
- Tool free installation

Launch date

- CCI: Available now
- CCM: Available now

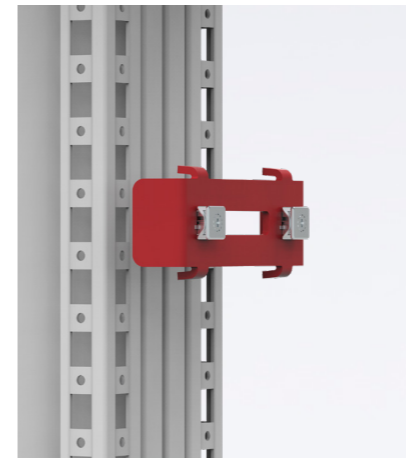

Good news for panel builders! You can now implement your nVent HOFFMAN bayed enclosure solutions much faster than ever before, without using tools.

nVent HOFFMAN's latest quick fixation baying solutions deliver panel builders with a fast installation turn-around, increasing their competitive edge, thanks to simplified installation solutions.

nVent HOFFMAN's innovative baying brackets for floor standing enclosures do not require any installation tools, enabling quick, one-man installation.

Addressing the competitive needs of a panel builder to achieve faster turn-around times, the CCI and CCM baying brackets take ease of use and speed of installation to a whole new level.

The brackets have undergone comprehensive testing, to ensure they fully meet the strictest standards when it comes to their loading and lifting capability.

The brackets are available as standard in the mild steel and stainless steel floor standing enclosure ranges.

Affected products

CCI, internal baying brackets

nVent HOFFMAN's internal baying brackets for combinable enclosures are delivered with quick click-in fixing solution, allowing panel builders to implement their bayed enclosure solutions much faster than ever before. This is due to the tool free fixation method as well as the reduction in the baying bracket's fixation points.

CCM, corner baying brackets

nVent HOFFMAN's corner baying brackets for combinable enclosures are delivered with quick click-in fixing solution. This fixation method allows you to build bayed enclosure solutions quickly and simply without tools. Installation can be carried out by one person, significantly reducing assembly costs for panel builders.

Scan the QR code to access nVent HOFFMAN's mounting instructions video gallery!



Floor Standing Enclosures

Profile system

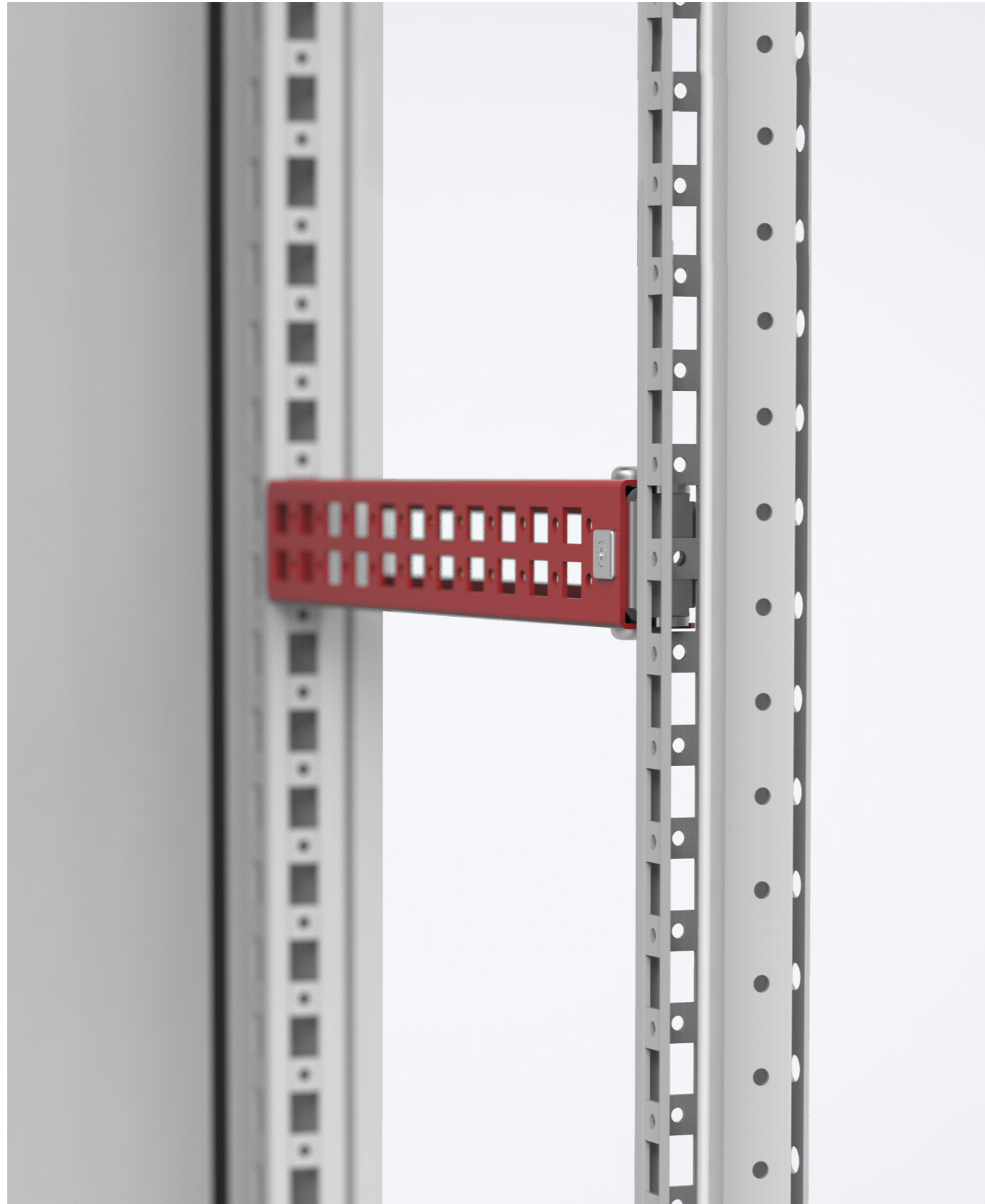

Customer benefits

- Tool free installation
- Reduced assembly time
- Pre-assembled brackets in the profile
- Tested load capacity

Launch date

- Available now

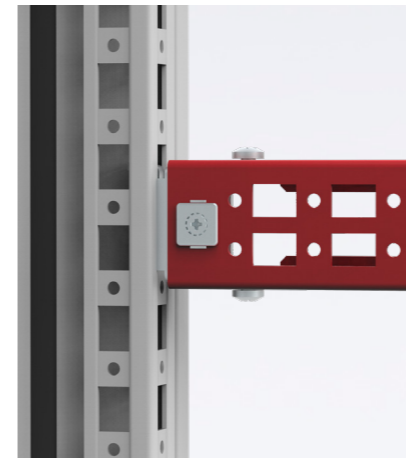

Cut your assembly time by up to 80%!

The CLPF profile system is supplied with the fixation bracket pre-assembled in the profile, thus significantly reducing the assembly time.

The CLPF profile system is a 40 mm wide and 25 mm high profile, which can be mounted in all directions on the enclosure's frame.

When the profile is in position, it is fixed with a click-in, therefore no tools are required for the installation.

The innovative fixation system allows brackets to pivot, and overall assembly time is drastically reduced.

When mounted on the frame of the enclosure, the profiles are flush with the enclosure's profiles. Two rows of hole patterns for cage nut fixing and self tapping screws are provided.

The CLPF profile system can also be used in combination with other accessories such as sliding nuts, GLM, to mount components which require continuous adjusting in depth.

Affected products

CLPF, mounting profiles

Item no.	Description	Max. Loading Horizontal C	Max. Loading Horizontal Π
CLPF300	Mounting profile, 300	800 N	1000 N
CLPF400	Mounting profile, 400	800 N	1000 N
CLPF500	Mounting profile, 500	800 N	1000 N
CLPF600	Mounting profile, 600	800 N	1000 N
CLPF800	Mounting profile, 800	800 N	1000 N
CLPF1000	Mounting profile, 1000	800 N	1000 N
CLPF1200	Mounting profile, 1200	800 N	1000 N
CLPF1400	Mounting profile, 1400	Only vertical loads allowed	Only vertical loads allowed
CLPF1600	Mounting profile, 1600	Only vertical loads allowed	Only vertical loads allowed
CLPF1800	Mounting profile, 1800	Only vertical loads allowed	Only vertical loads allowed
CLPF2000	Mounting profile, 2000	Only vertical loads allowed	Only vertical loads allowed
CLPF2200	Mounting profile, 2200	Only vertical loads allowed	Only vertical loads allowed

Scan the QR code to access nVent HOFFMAN's mounting instructions video gallery!



Floor Standing Enclosures

Side panels fixation with new patented retainer



Customer benefits

- Reduced assembly time
- Tested load capacity: 1000 N
- No cage nuts are required

Launch date

- Available now

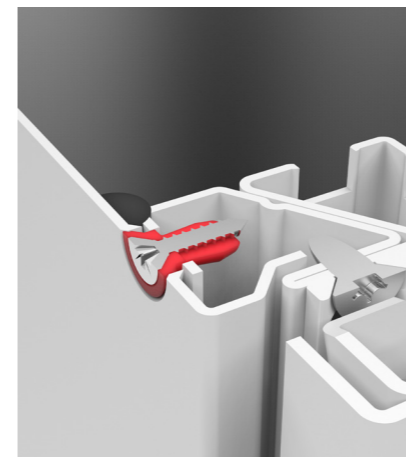

nVent HOFFMAN's side panels for the floor standing range, including SPM / SPMS maintain ingress protection to ensure that electrical components operate without any disturbances and protect personnel from injuries. Proper sealing is provided through an extruded, one-piece polyurethane gasket. The panel is mounted with 8 screws.

A new patented retainer has been introduced to make mounting these panels even easier. The new retainers replace the cage nuts to allow for faster fixation of a side panel by one person. The retainers will be delivered mounted on the side panels for the mild steel, stainless steel and aluminium ranges.

The new retainer is inserted without tools through the side panel on to the enclosure frame. The retainer remains in position in the side panel thanks to two slots in the panel and two positioners on the retainer. When the screw is screwed in, the retainer expands, providing a strong and reliable fixation of the side panel to the enclosure.

The process to mount a side panel is now as follows:

- The side panel is hung on the enclosure frame;
- The retainers are inserted into the enclosure frame holes and clicked-in;
- A screw needs to be inserted and pushed into position in each retainer.

The new retainer makes the whole assembly process easier and reduces assembly time, since no tools are required for positioning the retainer into the frame. With the previous cage nuts it was more complicated and time consuming to make sure the cage nut was in the right position.

Comprehensive tests of the new fixation method have been conducted, to ensure the required loading capacity can be met, for example for big cooling units with weights up to 80 Kg. Other tests have proved that proper fastening can also be maintained in high vibration environments or seismic environments.

The new fixation method is a standard feature on mild steel, stainless steel, and aluminium side panels for combinable floor standing enclosures.

Affected products

- SPM, mild steel side panels
- SPMS, stainless steel side panels

Floor Standing Enclosures

Mounting filler plate



Customer benefits

- Tool free installation
- Reduced assembly time
- One-man installation

nVent HOFFMAN's new mounting filler plate reduces assembly time thanks to a quick click-in fixing solution, and a new design, based on a supporting guide bar.

The MPF filler plate is a flat mounting surface, which allows to get a continuous mounting surface for bayed combinable floor standing enclosures.

The new top bracket is fixed with a click-in fixing solution to the top middle frame, and a supporting bar is mounted between mounting plates. This metallic bar services at the same time as bottom fixation and as guide for the filler plate.

The MPF can be now flushed between mounting plates and easily fixed, with a click-in fixing solution, to the top bracket.

Launch date

- Available now

Affected products

MPF, filler plates

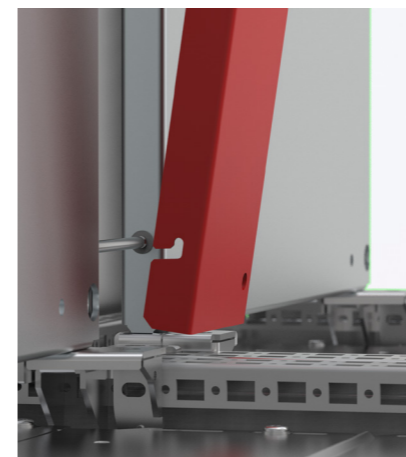

Scan the QR code to access nVent HOFFMAN's mounting instructions video gallery!



Floor Standing Enclosures

Floor standing combinable enclosure with IP 66 rating



Customer benefits

- High ingress protection
- Flexible solution that allows baying configurations to achieve IP 66
- Full accessory compatibility
- Fast and tool free baying installation

Launch date

- Available now

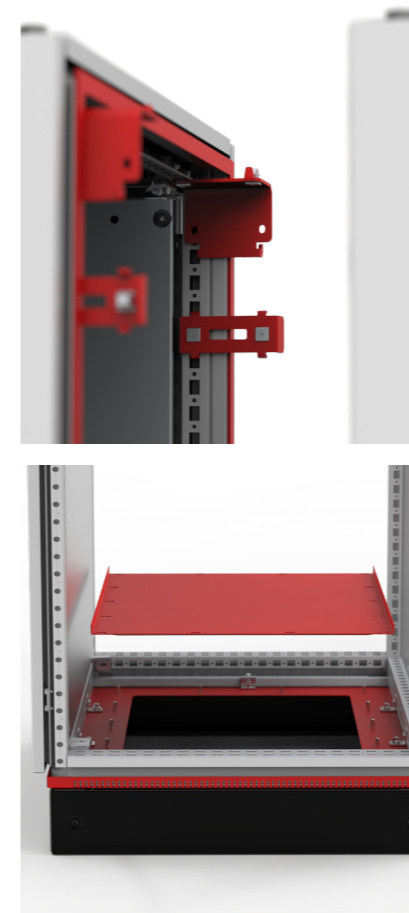

nVent HOFFMAN has now added a new IP 66 rated floor standing combinable range in mild steel and stainless steel to its extensive floor standing product programme.

The new version offers a higher protection level for equipment and components, which will help extend their lifetime and reduce maintenance costs when the enclosure is installed for rough environments with severe conditions.

The profile system is identical to the standard combinable range, which make it fully compatible with the combinable floor standing accessory range.

The new enclosure version is accompanied by a new puzzle gasket to achieve IP 66 also in bayed configurations, when it is used in combination with CCI and CCM baying brackets.

Thanks to the baying puzzle gasket, the kit can be used for all standard floor standing dimensions, since the gasket needed can be easily pushed out from the pad with different gasket configurations.

Affected products

Baying puzzle gasket for IP 66

Item no.
HPPG01

MCS-HP, mild steel floor standing combinable enclosures IP 66 rating

Item no.	Height (mm)	Width (mm)	Depth (mm)
MCS20086HP	2000	800	600

MCSS-HP, stainless steel floor standing combinable enclosures, IP 66 rating

Item no.	Height (mm)	Width (mm)	Depth (mm)
MCSS20086HP	2000	800	600

Floor Standing Enclosures

Outdoor combinable floor standing enclosure

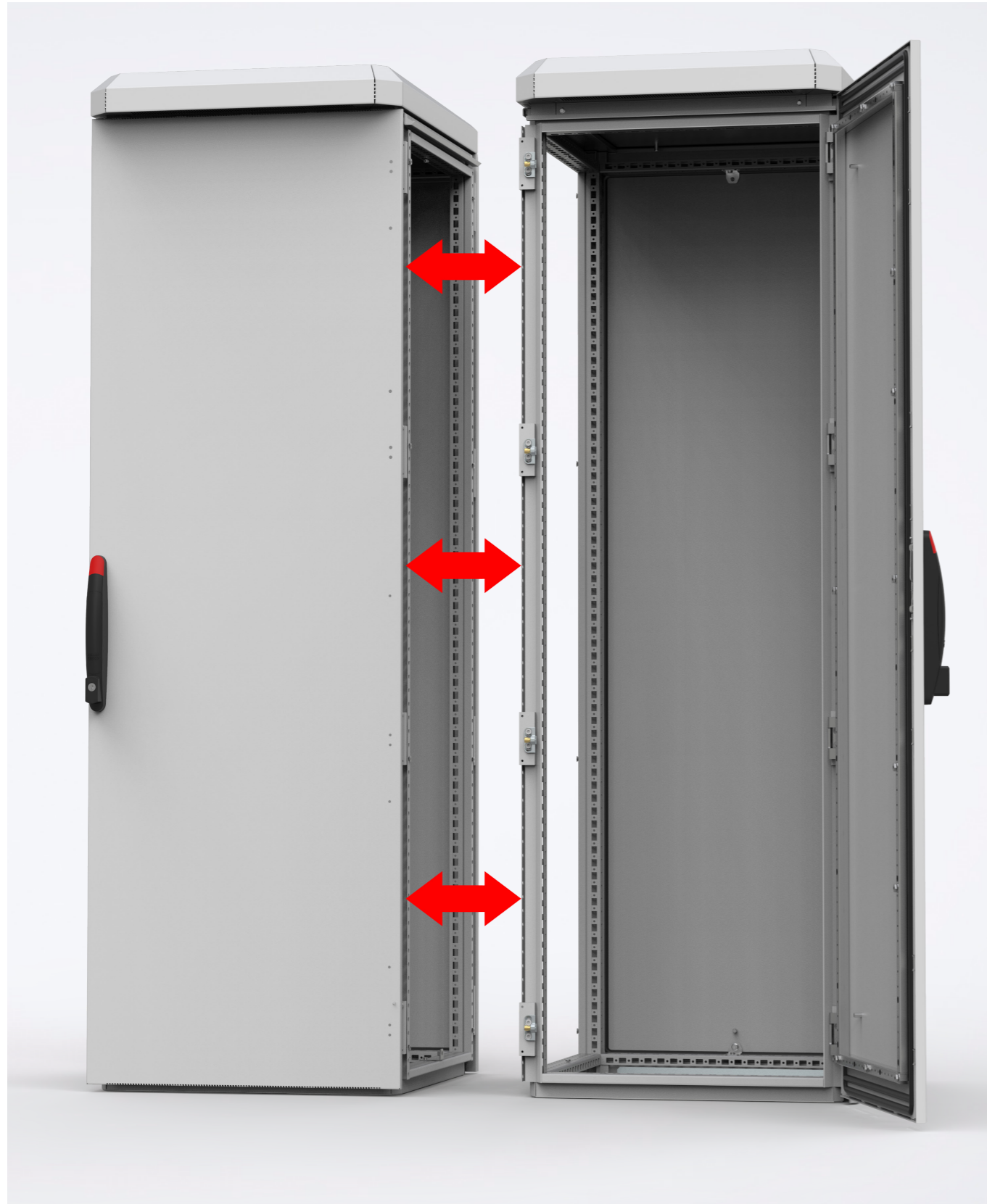

Customer benefits

- Flexible design: allows outdoor enclosure assemblies to be built in different dimensions, according to needs
- Anti-vandalism: panel joints are gap-less, and all fitting elements and screws are hidden and not accessible from the outside
- Corrosion resistance: the stainless steel frame and the aluminium walls provide higher corrosion resistance properties than mild or galvanized steel alternatives

Launch date

- Available now

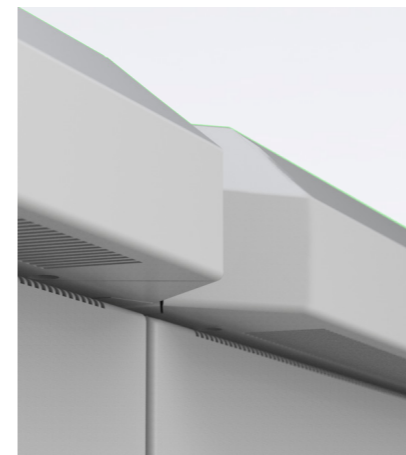

nVent HOFFMAN's outdoor enclosures range has been expanded with a new outdoor combinable floor standing version, equipped with a stainless steel frame and double aluminium walls. The combinable design provides extensive flexibility to the solution, allowing assemblies to be built in a number of different dimensions.

The walls of the enclosures in the floor standing aluminium range are made from high quality marine grade aluminium, AlMg3, which is light and highly corrosion resistant. This material also offers good heat dissipation and the double wall design provides 80% higher cooling efficiency than a single wall version, if the enclosure is installed outdoors and exposed to the sun.

The new outdoor combinable floor standing enclosure is based on the stainless steel floor standing enclosure and, since it uses the same frame design, all the accessories are compatible.

Typical applications are outdoor and range from rail and road traffic control equipment to water treatment plants and telecommunication applications in the field. The welded frame guarantees a strong, rigid enclosure which is well suited for heavy duty applications.

A wide range of accessories allows for any configuration. And, since all enclosure versions are designed around the same platform, the same accessories may be used on all versions.

This makes engineering easier and allows for stock reduction with panel builders and distributors. Assembly is easy and will help you to reduce assembly time and remain competitive.

Affected products

ECOM, combinable single door aluminium floor standing outdoor enclosure

Item no.	Width (mm)	Depth (mm)	Height (mm)
ECOM16066	600	600	1600
ECOM16086	800	600	1600
ECOM18066	600	600	1800
ECOM18086	800	600	1800
ECOM20066	600	600	2000
ECOM20086	800	600	2000

SPMA, aluminium side panels

Item no.	Depth (mm)	Height (mm)
SPMA1606	600	1600
SPMA1806	600	1800
SPMA2006	600	2000

Scan the QR code to access NVent HOFFMAN's mounting instructions video gallery!

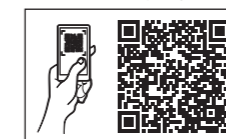

Floor Standing Enclosures

Flange mount disconnect enclosure



Customer benefits

- Improved aesthetics and feel
- High ingress protection
- The predefined cut-out reduces machining time and can be matched with the most common switches in the market
- MCF-enclosures and the FMD interlocking kit meet US requirements set out in UL 508A

Launch date

- Available now



nVent HOFFMAN has launched a new flange mount disconnect enclosure. The new enclosure is launched in combination with the upgraded interlocking system.

The new nVent HOFFMAN's mild steel combinable flange mount disconnect floor standing range, MCF, now include a new user-friendly locking system, with new top/bottom locks on the right-hand door.

nVent HOFFMAN's MCF range, must be combined with the main door interlocking kit, FMD, ensuring that access to the main enclosure is restricted when the power is switched on, minimizing the risk of injury.

Affected products

MCF, flange mount disconnect enclosures

Item no.	Height (mm)	Width (mm)	Depth (mm)
MCF18084R5	1800	800	400
MCF18085R5	1800	800	500
MCF18105R5	1800	1000	500
MCF20085R5	2000	800	500
MCF20086R5	2000	800	600
MCF20105R5	2000	1000	500

FMD, main door interlocking kit

Item no.	Description
FMD01	Main door interlocking kit

Scan the QR code to access nVent HOFFMAN's mounting instructions video gallery!



Floor Standing Enclosures

Interlocking system

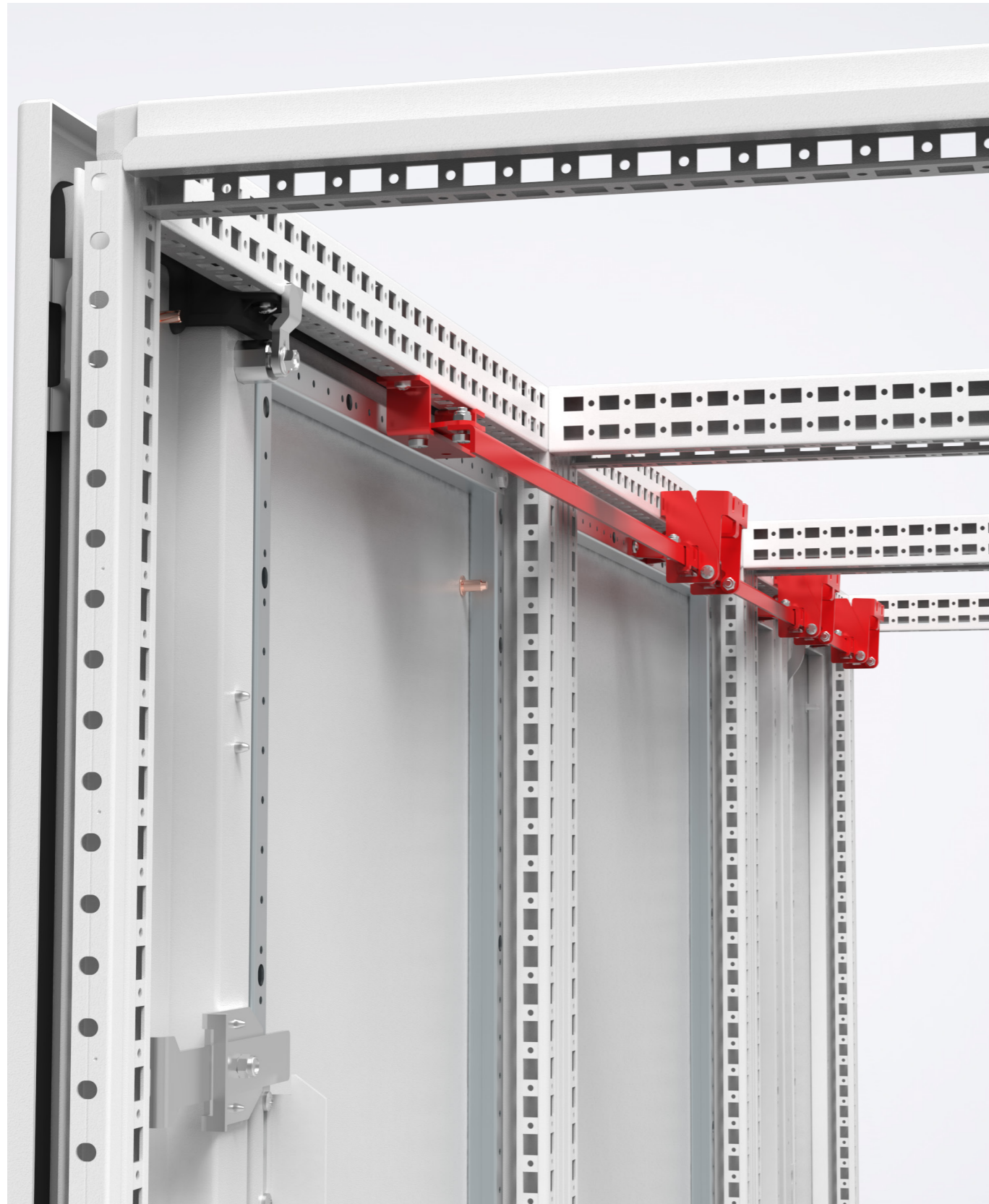

Customer benefits

- Shorter assembly time
- Smoother operation
- Stronger mechanisms

Launch date

- Available now

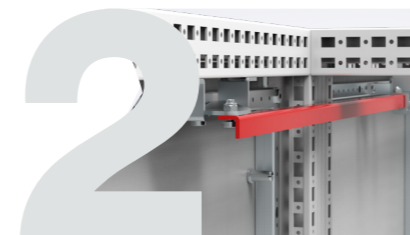

nVent HOFFMAN has launched a new interlocking system for bayed enclosure configurations. The new system is launched in combination with the upgraded flange mount disconnect floor standing enclosures, the MCF-range.

The new interlocking system design reduces assembly time and provides a smoother interlocking operation while increasing the strength of the mechanism thanks to new L-shaped interlocking bars, FMB.

nVent HOFFMAN's interlocking system is simple: The master door in the configuration must first be identified, and the system actuator, FMA, is then to be installed there. This in turn will lock all slave doors through the connection between the interlocking bars, FMB, and the slave door kits, FMS, with a completely new design.

The system can accommodate as many slave door interlocking kits as the bayed enclosure configuration requires and it is symmetrical, so the master door will block doors left or right, meeting the requirements specified within UL 508A for control panels, which is required in the US.

Affected products

FMA, system actuator

Item no.	Description
FMA01	System actuator

FMS, slave door interlocking kit

Item no.	Description
FMS01	Slave door interlocking kit

FMB, interlocking bar

Item no.	Description	Width
FMB600	Interlocking bar, 600	600
FMB800	Interlocking bar, 800	800
FMB1000	Interlocking bar, 1000	1000
FMB1200	Interlocking bar, 1200	1200

Scan the QR code to access nVent HOFFMAN's mounting instructions video gallery!



Floor Standing Enclosures

Outer mounting profile

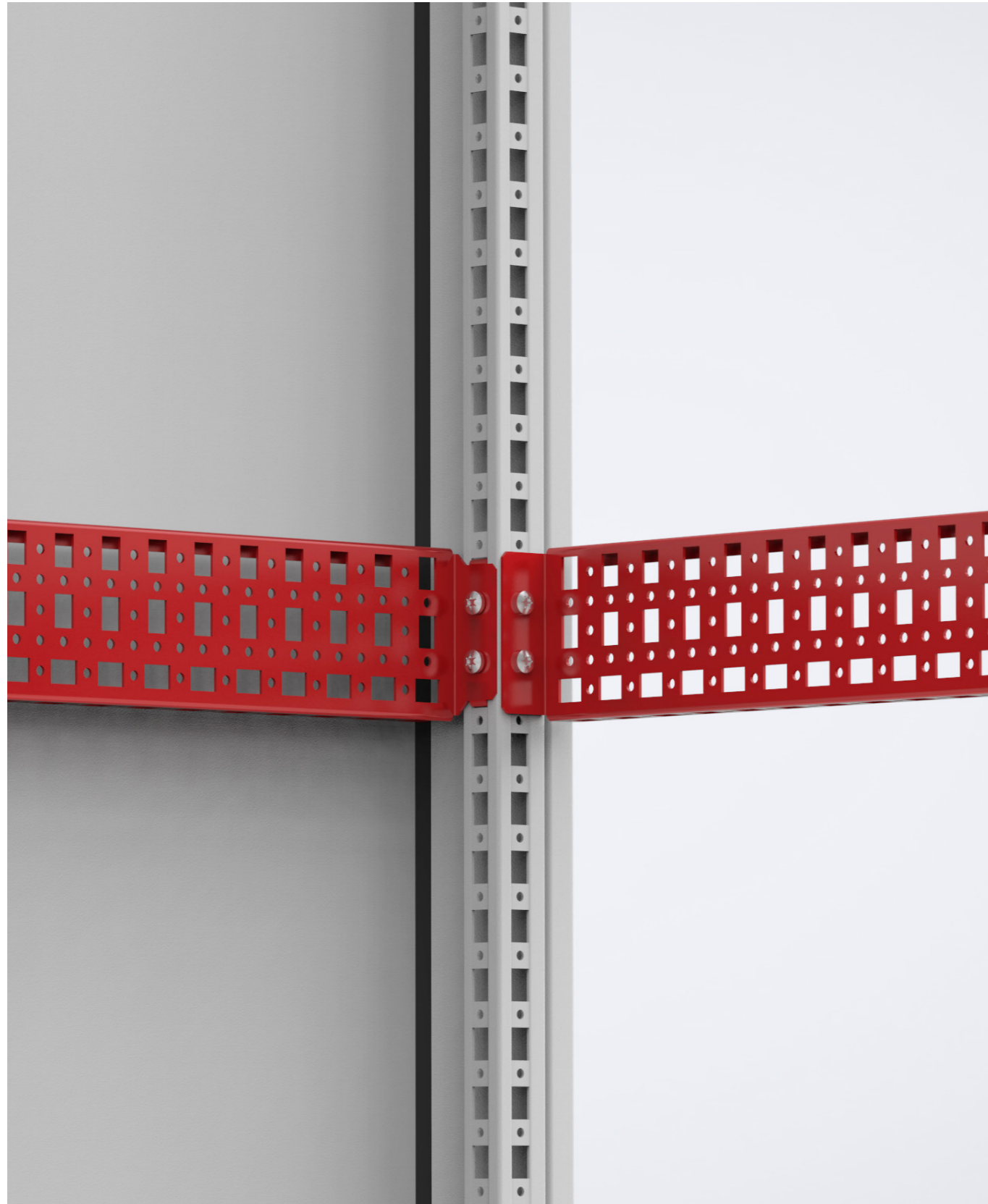

Customer benefits

- Easy positioning
- Reduced assembly time
- Tested loaded capacity
- Increases the useful depth/width in the enclosure with 25 mm

Mounting profile for the outer mounting level. Mounting profiles are used in all of nVent HOFFMAN's floor standing enclosure to mount components or peripherals inside the enclosure at different levels.

The new outer profiles allows for greater mounting flexibility and can be used for all applications.

Each profile has hooks on one side that keep the profile in the desired position while the other side is being fixed. This makes assembly very easy.

The new profile replicates the standard hole pattern at an outer mounting level, offering an extra +25 mm space for various configurations.

Launch date

- Available now

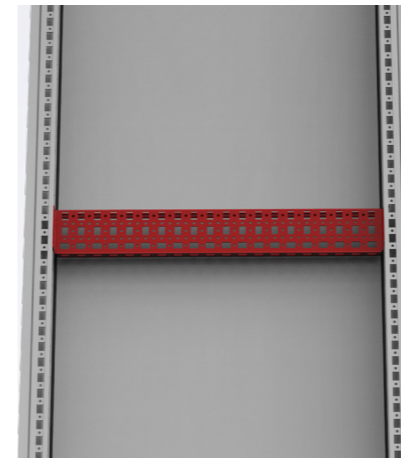

Affected products

CLPO, outer mounting profile

Item no.	Description	Width/Depth	Max. loading
CLPO300	Outer mounting profile, 300	300	2400 N
CLPO400	Outer mounting profile, 400	400	2400 N
CLPO500	Outer mounting profile, 500	500	2400 N
CLPO600	Outer mounting profile, 600	600	2400 N
CLPO800	Outer mounting profile, 800	800	1800 N
CLPO1000	Outer mounting profile, 1000	1000	1400 N
CLPO1200	Outer mounting profile, 1200	1200	1200 N

Scan the QR code to access nVent HOFFMAN's mounting instructions video gallery!



Floor Standing Enclosures

Swing frame retainer



Customer benefits

- Top or bottom assembly
- Available for 130° and 180° opening angles
- Reinforced U-shaped retainer body
- Safety button for unblocking the mechanism

The swing frame retainer prevents the swing frame from closing unexpectedly. This increases work safety significantly.

The retainer allows for flexible mounting, meaning that it can be mounted either in the top or bottom of the the swing frame.

There are two versions of the retainer available to meet different applications. One is for 130° opening angle, the other is for 180° opening angle.

The body of the retainer has been redesigned and is now U-shaped. This new design increases the strength of the retainer and makes it function perfectly also with a heavy loaded swing frame.

When the swing frame is in the blocked position (open swing frame), the mechanism can only be released by pressing the safety button, which prevents the swing frame from closing unexpectedly.

Launch date

- Available now

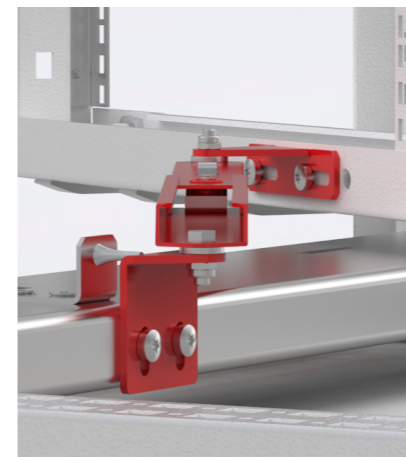
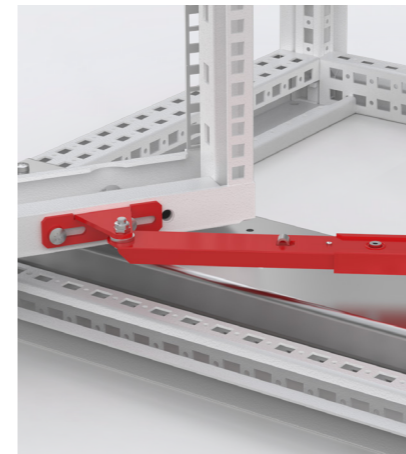

Affected products

ESFD, swing frame retainer

Item no.	Description	Opening angle
ESFD130	Swingframe door stop	130°
ESFD180	Swingframe door stop	180°

Scan the QR code to access nVent HOFFMAN's mounting instructions video gallery!



Floor Standing Enclosures

Mounting plate brackets for mounting from the rear



Customer benefits

- Mounting from the rear
- Allowing front and rear unmounting
- The useful depth of the enclosure can be increased by 20 mm

Mounting plate brackets kit for rear mounting

Mounting plates are used on all of nVent HOFFMAN's floor standing enclosure ranges for mounting of components inside the enclosure. This is to ensure the integrity of the enclosure is unaffected and that IP and IK ratings are maintained.

The new mounting plate brackets, MPA04R, allow for installation of the mounting plate from the rear of the enclosure. This is a common operation for applications where the mounting plate is heavy loaded with equipment.

The new kit includes brackets allowing for two different mounting options. One is for a mounting position flush with the enclosure frame. The other one is set back behind the enclosure frame that creates an extra +20 mm of useful depth.

The mounting plate is removable from both the front and rear for servicing, even if it has been mounted from rear.

Launch date

- Available now

Affected products

MPA04R, mounting plate brackets for rear mounting

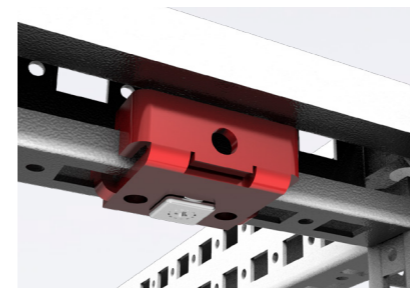
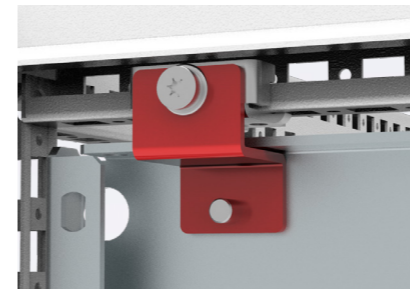

Scan the QR code to access nVent HOFFMAN's mounting instructions video gallery!



Wall Mounted Enclosures

New locking system



Customer benefits

- Increased security thanks to the metallic double-bit insert
- Smoother closing in the enclosures with espagnolette
- Reliable protection degree even in high loaded doors

The security is very important for wall mounted enclosures, for this reason the lock in mild steel enclosures is now made from metal, the same as in the stainless steel enclosures. The new locking system increases the reliability of the protection degree even in doors carrying high loads.

The lock, which has been changed from plastic to metal, is included in all the wall mounted enclosures, irrespective of size. The metallic double-bit insert makes the enclosure safer since it guards against the pin breaking. The earthing of the lock is a must and this is easily done with the special fixation nut which electrically connects the lock with the door.

In enclosures 1000 mm high and higher, the lock acts on an espagnolette locking system, and this system has also been improved. The new locking system includes two wheels top and bottom, which make closing and opening much smoother.

A further improvement is that the plastic holders which guide the rods have a new geometry which puts the door in the right position during closing. This guarantees that the sealing between the door gasket and the enclosure rain gutter is perfect, even in applications in which the door is heavily loaded and may tend to hanging. The gasket compression is improved and any risk of the door not closing completely is avoided.

Launch date

- Available now



Affected wall mounted enclosures

MAS, mild steel single door enclosures (H ≥ 1000mm)

MAD, mild steel double door enclosures

ASR, stainless steel single door enclosures (H ≥ 1000mm)

ADR, stainless steel double door enclosures

Wall Mounted Enclosures

180° hinges



Customer benefits

- Die cast manufacturing which improves the aesthetics
- Easier and faster assembly
- Machining is not required

Now available for our our wall mounted enclosures is a new range of 180° hinges that can be retrofitted without any machining where necessary. The new hinges are produced by die casting which greatly improves the aesthetics.

Since the new 180° hinges are assembled in the same way as the standard hinges, in the body and in the door, replacing the standard hinges with the new 180° hinges is extremely easy. No additional machining is required; the task can be carried out quickly, even in the field, and with the enclosure completely equipped.

180° hinges are often required for wall mounted enclosures because, in many applications, it is an advantage to have a door opening of more than the standard 130°. This is particularly true when maintenance or other work inside the enclosure is required in the field, since it makes the job much easier.

In some cases this need is identified when the enclosure is already installed. In this situation our new hinge offers major advantages since it can be installed quickly and easily without any machining (always a complex task and sometimes impossible in the field).

Launch date

- Available now

Affected products

MMH, 180° hinges for mild steel wall mounted enclosures

MMHS, 180° hinges for stainless steel wall mounted enclosures



Scan the QR code to access nVent HOFFMAN's mounting instructions video gallery!



Wall Mounted Enclosures

Depth interior profile



Customer benefits

- Easy to use profile which does not require machining
- Flexible system for mounting equipment

Now available is a new mounting profile for wall mounted enclosures which gives much greater scope for mounting typical accessories, such as lights or temperature control equipment, inside the enclosure.

The assembly of the profile does not require any machining, which would put at risk the protection degree of the enclosure. Assembly is extremely easy, it is simply a case of placing the profile in position and tightening one screw.

The profile includes the standard 25 mm hole pattern normally used in the other profile systems to make design and fixing of the components easier. It must always be installed in depth, but in any position on the sides, bottom or top.

With the new DIP profiles we can also use the profiles system CLPF in the wall mounted enclosures. CLPF are normally used in the floor standing range, in wall mounted enclosures it can be mounted between two DIP profiles.

Launch date

- Available now



Affected products

DIP, depth interior profiles

Item no.	Description	Depth (mm)	Max. loading
DIP210	Depth interior profile, 210	210	150N
DIP260	Depth interior profile, 260	260	150N
DIP300	Depth interior profile, 300	300	150N
DIP400	Depth interior profile, 400	400	150N

Scan the QR code to access nVent HOFFMAN's mounting instructions video gallery!



Wall Mounted Enclosures

Door wheel for MAS



Customer benefits

- Reliable protection degree when the enclosure is mounted on uneven surfaces
- Smoother door closing with heavily loaded doors

An enclosure must maintain the specified protection degree, even if the mounting surface is uneven or if the door is heavily loaded. Situations like this could affect the relative position between the body and the door and reduce the seal in between.

nVent HOFFMAN now offers a new door wheel to be mounted on the enclosure door to make sure the enclosure door closes perfectly and tightly, and to ensure the stated protection degree is maintained.

The new door wheel is available for nVent HOFFMAN's wall mounted enclosures in mild steel and stainless steel. It is useful when the enclosure is mounted on an uneven surface or when the door is heavily loaded. The door wheel makes closing easier and smoother and guarantees that the seal between the gasket and the enclosure body is perfect.

This accessory is especially useful for wall mounted enclosures up to a height of 800 mm, since these enclosures do not have an espagnolette locking system with a rod guide that helps position the door into position.

The door wheel can be installed easily in all nVent HOFFMAN's wall mounted enclosures without any machining thanks to fixing profile studs on the door. The door wheel cannot be mounted in enclosures with a lower height than 300 mm, since these are not provided with door studs, but in these cases the risk of poor sealing is almost zero.

Launch date

- Available now



Affected products

DW, door wheel

Item no.
DW02

Scan the QR code to access nVent HOFFMAN's mounting instructions video gallery!



Thermal management

Slim Fit indoor air conditioner



Customer benefits

- Slim depth with 3 mounting options
- Active condensate management
- Wide operating temperature range, 10°C to 55°C
- Smart controller with easy set-up, status codes and alarm output

Launch date

- December 2020



Slim Fit indoor air conditioner – loaded with features and options!

Slim Fit air conditioners are specially designed and developed to meet the requirements of industrial customers worldwide. Slim Fit air conditioners are easy to specify and ready to use. The standard unit has three mounting options: surface, partially recessed and fully recessed, all in the same model.

Slim Fit air conditioners are equipped with active condensate management and therefore continuously evaporate the water that might be in the drain pan due to condensation from the evaporator coil. Steam goes out into the external ambient air with the air flow of the condenser fan. With filterless operation, global certification and remote access controller, the Slim Fit air conditioner simplifies automation cooling for system designers and operations maintenance teams around the world.

All units are tested for IP 54 and have an operating temperature range of 10°C to 55°C. The unit is available in a cooling capacity range of 300W to 4000W.

The units have an attractive design that optimizes the air flow and are delivered with a smart controller. They can be changed easily.

Affected products

Slim Fit indoor cooling units

Item no.	Description	Power supply (V/PH/Hz)	Height (mm)	Width (mm)	Depth (mm)
S060316G031	Slimfit cooling unit 300W	115 / 1 / 50-60	550	280	140
S060326G031	Slimfit cooling unit 300W	230 / 1 / 50-60	550	280	140
S060316G041	Slimfit cooling unit 300W*	115 / 1 / 50-60	550	280	140
S060326G041	Slimfit cooling unit 300W*	230 / 1 / 50-60	550	280	140
S060516G031	Slimfit cooling unit 500W	115 / 1 / 50-60	550	280	206
S060526G031	Slimfit cooling unit 500W	230 / 1 / 50-60	550	280	206
S060516G041	Slimfit cooling unit 500W*	115 / 1 / 50-60	550	280	206
S060526G041	Slimfit cooling unit 500W*	230 / 1 / 50-60	550	280	206
S101016G031	Slimfit cooling unit 1000W	115 / 1 / 50-60	950	400	259
S101026G031	Slimfit cooling unit 1000W	230 / 1 / 50-60	950	400	259
S101046G031	Slimfit cooling unit 1000W	400 / 1 / 50 - 460 / 1 / 60	950	400	259
S101016G041	Slimfit cooling unit 1000W*	115 / 1 / 50-60	950	400	259
S101026G041	Slimfit cooling unit 1000W*	230 / 1 / 50-60	950	400	259
S101046G041	Slimfit cooling unit 1000W*	400 / 1 / 50 - 460 / 1 / 60	950	400	259
S101516G031	Slimfit cooling unit 1500W	115 / 1 / 50-60	950	400	259
S101526G031	Slimfit cooling unit 1500W	230 / 1 / 50-60	950	400	259
S101546G031	Slimfit cooling unit 1500W	400 / 3 / 50 - 460 / 3 / 60	950	400	259
S101516G041	Slimfit cooling unit 1500W*	115 / 1 / 50-60	950	400	259
S101526G041	Slimfit cooling unit 1500W*	230 / 1 / 50-60	950	400	259
S101546G041	Slimfit cooling unit 1500W*	400 / 3 / 50 - 460 / 3 / 60	950	400	259
S162016G031	Slimfit cooling unit 2000W	115 / 1 / 50-60	1580	400	259
S162026G031	Slimfit cooling unit 2000W	230 / 1 / 50-60	1580	400	259
S162046G031	Slimfit cooling unit 2000W	400 / 3 / 50 - 460 / 3 / 60	1580	400	259
S162016G041	Slimfit cooling unit 2000W*	115 / 1 / 50-60	1580	400	259
S162026G041	Slimfit cooling unit 2000W*	230 / 1 / 50-60	1580	400	259
S162046G041	Slimfit cooling unit 2000W*	400 / 3 / 50 - 460 / 3 / 60	1580	400	259
S162516G031	Slimfit cooling unit 2500W	115 / 1 / 50-60	1580	400	259
S162526G031	Slimfit cooling unit 2500W	230 / 1 / 50-60	1580	400	259
S162546G031	Slimfit cooling unit 2500W	400 / 3 / 50 - 460 / 3 / 60	1580	400	259
S162516G041	Slimfit cooling unit 2500W*	115 / 1 / 50-60	1580	400	259
S162526G041	Slimfit cooling unit 2500W*	230 / 1 / 50-60	1580	400	259
S162546G041	Slimfit cooling unit 2500W*	400 / 3 / 50 - 460 / 3 / 60	1580	400	259
S164046G031	Slimfit cooling unit 4000W	400 / 3 / 50 - 460 / 3 / 60	1580	500	340
S164046G041	Slimfit cooling unit 4000W*	400 / 3 / 50 - 460 / 3 / 60	1580	500	340

* Remote Access Control

Thermal management

T-Series outdoor air conditioner



Customer benefits

- Reliable robust design
- Wide operating temperature range -40°C to 55°C
- Reliable mechanical thermostat

T-Series outdoor air conditioner – proven robust design for rugged environments

The T-Series air conditioner is designed to withstand outdoor conditions. It is delivered with a cleanable, reusable aluminum mesh filter. The unit is designed with a compact footprint and equipped with easy-mount flanges for simple installation.

The unit is tested for IP 56 and comes in a surface-coated galvanized sheet-metal cover for rugged factory and outdoor environments. It is also available in a stainless-steel model, Type 304. Units in the T-Series have a wide operating temperature range, from -40°C to 55°C . Standard models are equipped with head pressure control for low ambient operation, compressor heater, coated condenser coil, malfunction switch, thermostat and heater package.

The T-Series units are equipped with a reliable mechanical thermostat located on the side of the enclosure.

Launch date

- December 2020



Affected products

T-Series outdoor air conditioners

Item no.	Description	Height (mm)	Width (mm)	Depth (mm)
T150116G150	T-Series outdoor 235W,115V	400	191	160
T150126G150	T-Series outdoor 264W,230V	400	191	160
T200216G150	T-Series outdoor 586W,115V	508	254	251
T200226G150	T-Series outdoor 586W,230V	508	254	251
T150116G152	T-Series outdoor-SS 235W,115V	400	191	160
T150126G104	T-Series outdoor-SS 264W,230V	400	191	160
T200216G155	T-Series outdoor-SS 586W,115V	508	254	251
T200226G103	T-Series outdoor-SS 586W,230V	508	254	251
T290416G150	T-Series outdoor 1172W,115V	737	432	287
T290426G150	T-Series outdoor 1172W,230V	737	432	287
T430616G150	T-Series outdoor 1958W,115V	1092	400	279
T430626G150	T-Series outdoor 1985W,230V	1092	400	279
T430816G150	T-Series outdoor 2500W,115V	1092	400	279
T430826G150	T-Series outdoor 2400W,230V	1092	400	279
T431016G150	T-Series outdoor 3016W,115V	1092	400	279
T431026G150	T-Series outdoor 3075W,230V	1092	400	279
T501226G150	T-Series outdoor 3516W,230V	1270	483	281
T531926G150	T-Series outdoor 5978W,230V	1346	533	330
T290416G159	T-Series outdoor-SS 1172W,115V	737	432	287
T290426G161	T-Series outdoor-SS 1172W,230V	737	432	287
T430616G102	T-Series outdoor-SS 1958W,115V	1092	400	279
T430626G159	T-Series outdoor-SS 1985W,230V	1092	400	279
T430816G153	T-Series outdoor-SS 2500W,115V	1092	400	279
T430826G108	T-Series outdoor-SS 2400W,230V	1092	400	279
T431016G102	T-Series outdoor-SS 3016W,115V	1092	400	279
T431026G104	T-Series outdoor-SS 3075W,230V	1092	400	279
T501226G125	T-Series outdoor-SS 3516W,230V	1270	483	281
T531926G109	T-Series outdoor-SS 5978W,230V	1346	533	330

Thermal management

SpectraCool with Advanced Corrosion Protection



Customer benefits

- Designed for harsh corrosive environments
- Active condensate management
- Reliable mechanical thermostat

The SpectraCool AC unit, with advanced corrosion system, is designed for environments exposed to harsh elements.

This SpectraCool air conditioner has an advanced corrosion system which provides industry leading corrosion protection for its performance-critical components. SpectraCool with Advanced Corrosion Protection is intended for applications where air conditioners are exposed to harsh, corrosive, chemical elements. nVent Hoffman utilizes advanced coatings to protect the critical components. This extends their life and, in turn, the life of the unit, as well as optimizing the performance of the product.

The SpectraCool units are equipped with active condensate management and therefore continuously evaporate the water that might be in the drain pan due to condensation from the evaporator coil. Steam goes out into the external ambient air with the air flow of the condenser fan.

Units in the SpectraCools Adanced Corrosion Protection family have a wide operating temperature range, from -40°C to 55°C , and are equipped with a reliable mechanical thermostat located on the side of the enclosure.

Level 1 protection

- Condenser coils are coated for protection against corrosion. Thermostat, soldered joints, including sensing bulb joint and copper, are coated for corrosion protection;
- All exposed copper tubing is coated for protection against corrosion.

Level 2 protection (only on request)

- All protective coating in level 1;
- Thermostat has additional protection thanks to a foam wrap over components and coatings;
- Evaporator coils are coated for protection against corrosion.

Launch date

- December 2020



Affected products

SpectraCool with advanced corrosion protection

Item no.	Description
N160116G102	Spectra ACP-SS, 278W,115V
N160126G102	Spectra ACP-SS, 237W,230V
N210216G102	Spectra ACP-SS, 645W,115V
N210226G102	Spectra ACP-SS, 571W,230V
G280416G102	Spectra ACP-SS, 1000W,115V
G280426G102	Spectra ACP-SS, 1260W,230V
G280446G102	Spectra ACP-SS, 1267W,400V
G280616G102	Spectra ACP-SS, 1758W,115V
G280626G102	Spectra ACP-SS, 1641W,230V
G280646G102	Spectra ACP-SS, 1481W,400V
G520816G102	Spectra ACP-SS, 1992W,115V
G520826G102	Spectra ACP-SS, 1758W,230V
G520846G102	Spectra ACP-SS, 2168W,400V
G521216G102	Spectra ACP-SS, 3135W,115V
G521226G102	Spectra ACP-SS, 2900W,230V
G521246G102	Spectra ACP-SS, 2540W,400V
G572026G102	Spectra ACP-SS, 4689W,230V
G572046G102	Spectra ACP-SS, 5656W,400V

SpectraCool Indoor G-Series SS

Item no.	Description
G280416G051	Spectra Indoor-SS 1000W,115V
G280426G051	Spectra Indoor-SS 1260W,230V
G280446G051	Spectra Indoor-SS 1267W,400V
G280616G051	Spectra Indoor-SS 1758W,115V
G280626G051	Spectra Indoor-SS 1641W,230V
G280646G051	Spectra Indoor-SS 1481W,400V
G520816G051	Spectra Indoor-SS 1992W,115V
G520826G051	Spectra Indoor-SS 1758W,230V
G520846G051	Spectra Indoor-SS 2168W,400V
G521216G051	Spectra Indoor-SS 3135W,115V
G521226G051	Spectra Indoor-SS 2900W,230V
G521246G051	Spectra Indoor-SS 2900W,400V
G572026G051	Spectra Indoor-SS 4689W,230V
G572046G051	Spectra Indoor-SS 5656W,400V

Thermal management

Thermoelectric coolers



Customer benefits

- Filterless design reduces maintenance requirements
- High IP
- No moving components, such as condensers and compressors, making it a reliable solution

Thermoelectric Cooler utilizes the Peltier effect to dissipate heat.

Thermoelectric Coolers minimize downtime and component loss by removing heat generated by critical components within an enclosure. These compact, low-profile coolers utilize the Peltier effect for cooling of small indoor and outdoor enclosures. Thermoelectric coolers have a small footprint with a low-profile design, making them a good solution for smaller enclosures. Thermoelectric coolers can be ordered with or without shroud and are mounted partially recessed on the enclosure. They are prewired, with a terminal block for easy wiring connections.

Thermoelectric coolers are tested for IP 65 and the different models are 24V or 48V DC powered.

No condensers, compressors or filters are required, making the unit a reliable solution for demanding low-maintenance environments. It is environment friendly since it contains no refrigerant.

Launch date

- December 2020



Affected products

Thermoelectric coolers

Item no.	Description	Input DC Voltage	Height (mm)	Width (mm)	Depth (mm)
TE090624020	Thermoelectric cooler 52W*	24	230	123	176
TE090624010	Thermoelectric cooler 52W**	24	236	128	176
TE090624011	Thermoelectric cooler 52W***	24	236	128	176
TE121024020	Thermoelectric cooler 94W*	24	300	153	188
TE121024010	Thermoelectric cooler 94W**	24	305	157	189
TE121024011	Thermoelectric cooler 94W***	24	305	157	189
TE121048020	Thermoelectric cooler 94W*	48	300	153	188
TE121048010	Thermoelectric cooler 94W**	48	305	157	189
TE162024020	Thermoelectric cooler 166W*	24	400	180	184
TE162024010	Thermoelectric cooler 166W**	24	405	187	185
TE162024011	Thermoelectric cooler 166W***	24	405	187	185
TE162048020	Thermoelectric cooler 166W*	48	400	180	184
TE162048010	Thermoelectric cooler 166W**	48	405	187	185

* Without shroud

** Painted shroud

*** Stainless Steel shroud

Others

ZONEX enclosures, EXE



Customer benefits

- ATEX and IECEx certifications
- Brass internal/external bonding provision
- Welded wall mounting brackets for easy installation

ZONEX enclosures deliver a robust solution for termination and junction enclosure applications in potentially hazardous locations, including: petroleum and chemical processing, water treatment processing, pharmaceutical processing, and grain processing.

ZONEX enclosures are designed and certified to meet ATEX Directive 94/9/EC as well as IECEx standards for increased safety (Ex e) in housing electrical components in Zone 1 and Zone 2 applications.

ZONEX stainless steel 316L enclosures are available with hinged cover or screw cover. The design includes an internal/external bonding provision. IP ratings are best guaranteed by avoiding holes, this is the case for hinged cover enclosures thanks to four individual welded wall mounting brackets on the rear. Screw cover enclosures include full width welded wall mounting brackets on rear top and bottom. The enclosures are certified to: Sira 09ATEX3224U, IECEx SIR 09.0099U, Ex eb IIC Gb, Ex tb IIIC Db IP 66, NEMA Type 4, 4X, 12.

ZONEX Fiberglass reinforced polyester terminal boxes are ideal for field terminations in hazardous locations. Thanks to its high-temperature silicone gasket and stainless steel 316 screws it can be used to protect equipment and terminations from corrosive contaminants while meeting rigorous demands. The terminal boxes are certified to: IBExU16ATEX1234 U, Ex eb IIC Gb, Ex tb IIIC Db IP 66, NEMA Type 4, 4X, 12.

Launch date

- December 2020



Internal/external bonding provision for supplementary bonding connection where local codes or authorities permit or require such connection.

Affected products

- EXE**SS61E, ZONEX stainless steel wall mounted enclosures
- EXE**SS6E, ZONEX stainless steel terminal boxes
- EXE, ZONEX polyester terminal boxes
- EXWK, hazardous location window kits
- LEDHL, hazardous location LED lights
- EXBD, hazardous location breather drains
- EXAS, hazardous location hole seals
- PLC/PCF, purge and pressurization systems
- DAHHL, hazardous location heaters
- NHZ, SpectraCool hazardous location
- VHL, hazardous location vortex enclosure coolers



Others

Operator Interface Control Enclosure, OICE



Customer benefits

- Reinforced fixation compatible with the swing arm systems
- Easy to remove aluminium front panel
- Unique finish due to extruded aluminium handles

Being one of the more visible parts of a machine, the control enclosure for HMI applications has an outstanding design and an excellent finish.

The control enclosure is one of the parts of the machine which is constantly being moved, therefore the fixation between the enclosure and the swing arm system must be extremely strong. In the new design, the roof of the enclosure has been reinforced with a 3 mm thickness steel plate. The compatibility with the swing arm systems is excellent, and the fixation does not require any machining.

The main equipment in the control enclosures is assembled on the aluminium front plate, significantly simplifying the assembly work. But in many cases auxiliary components must be mounted inside the enclosure, and the fixation studs available allow the customer to use standard accessories from the steel terminal boxes range, such as profiles or mounting plates, easy and without any machining.

The extruded aluminium handles, the plastic parts to cover the front plate fixation, together with the improved overall design considerably improve the aesthetics of the enclosure.

Launch date

- Available now

Affected products

OICE, operator interface control enclosure



Others

Swing arm systems



Customer benefits

- Easy to install
- Smooth design for easy cleaning
- Wide range of components
- Tested load capacity

The upgraded light swing arm system combines functionality with appealing design.

The new system is an important addition to the medium system. It is easy to install and has outstanding visual appeal with smooth transitions between tube and components. It is designed for easy cleaning.

In addition, the wide range of components, the high strength of the system, and the load capacity allow for flexible solutions. The new light swing arm system has higher loading capacity compared to the previous system. The upgraded system has a maximum load capacity of 800N.

Launch date

- December 2020

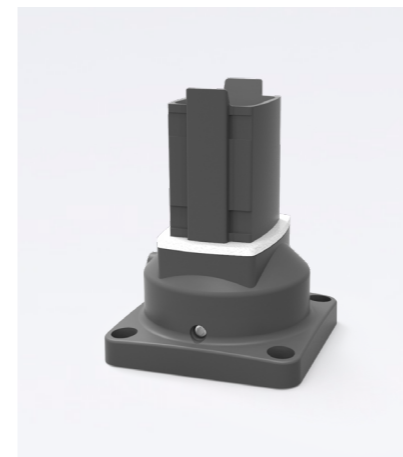

Affected products

Swing arm medium system

Item no.	Description
S2MT250	Operator arm profile
S2MT500	Operator arm profile
S2MT750	Operator arm profile
S2MT1000	Operator arm profile
S2MT1250	Operator arm profile
S2MT1500	Operator arm profile
S2MT1750	Operator arm profile
S2MT2000	Operator arm profile
S2MWF	Base/ wall flange
S2MRB	Rotary base bracket
S2MSJ	Set up joint
S2MWJV	Wall joint Vertical
S2MWJH	Wall joint horizontal
S2ME	Elbow
S2MER	Rotation elbow
S2MIJ	Intermediate joint
S2MFC	Couple kit HMI
S2MFEC	Elbow couple kit
S2MTA	Tube adapter
S2MACB	Angled coupling tilted back
S2MACF	Angled coupling tilted forw.
S2MBC	Base coupling
S2MAA	Angeld adapter
S2MFC48	48-mm round tube flange coupling medium
S2MA48	48-mm round tube flange adapt.
S2M10VP22	Vertical motion pedestal
S2M10VP37	Vertical motion pedestal
S2M10VP57	Vertical motion pedestal
S2M10VP77	Vertical motion pedestal
S2MPBS	Small pedestal base
S2MLSAR	Light signal adapter round
S2MLSAE	Light signal adapt. rectangle
S2MRL	Rotation limiters
S2MTHP	Tube hole plugs

Swing arm light system

Item no.	Description
S1MT250	Operator arm profile, light
S1MT500	Operator arm profile, light
S1MT750	Operator arm profile, light
S1MT1000	Operator arm profile, light
S1MT1250	Operator arm profile, light
S1MT1500	Operator arm profile, light
S1MWF	Base/ wall bracket, light
S1MTBB	Rotary base bracket, light
S1MSJ	Set up joint, light
S1MWJV	Wall joint vertical, light
S1MWJH	Wall joint horizontal, light
S1ME	Elbow, light
S1MIJ	Intermediate joint, light
S1MER	Rotatable elbow, light
S1MFC	Coupling HMI, light
S1MFEC	Elbow coupling HMI, light
S1MA	Narrow adapter, light
S1MPCH	Horiz. panel coupling,light
S1MPCV	Vertical panel coupling, light
S1MRE	Reduction elbow, light
S1MRL	Rotation limiter (aluminum)
S1MSLAR	Signal light adapter,round
S1MSLAA	Signal light adapter,angled
S1MSLARE	Signal light adapter, reduction
S1MRCRK	Replacement cap kit,round
S1MRCAK	Replacement cap kit,angled
S1MRCREK	Replacement cap kit, reduction
S1MRHK	Replacement hardware kit

Others

Earthing portfolio

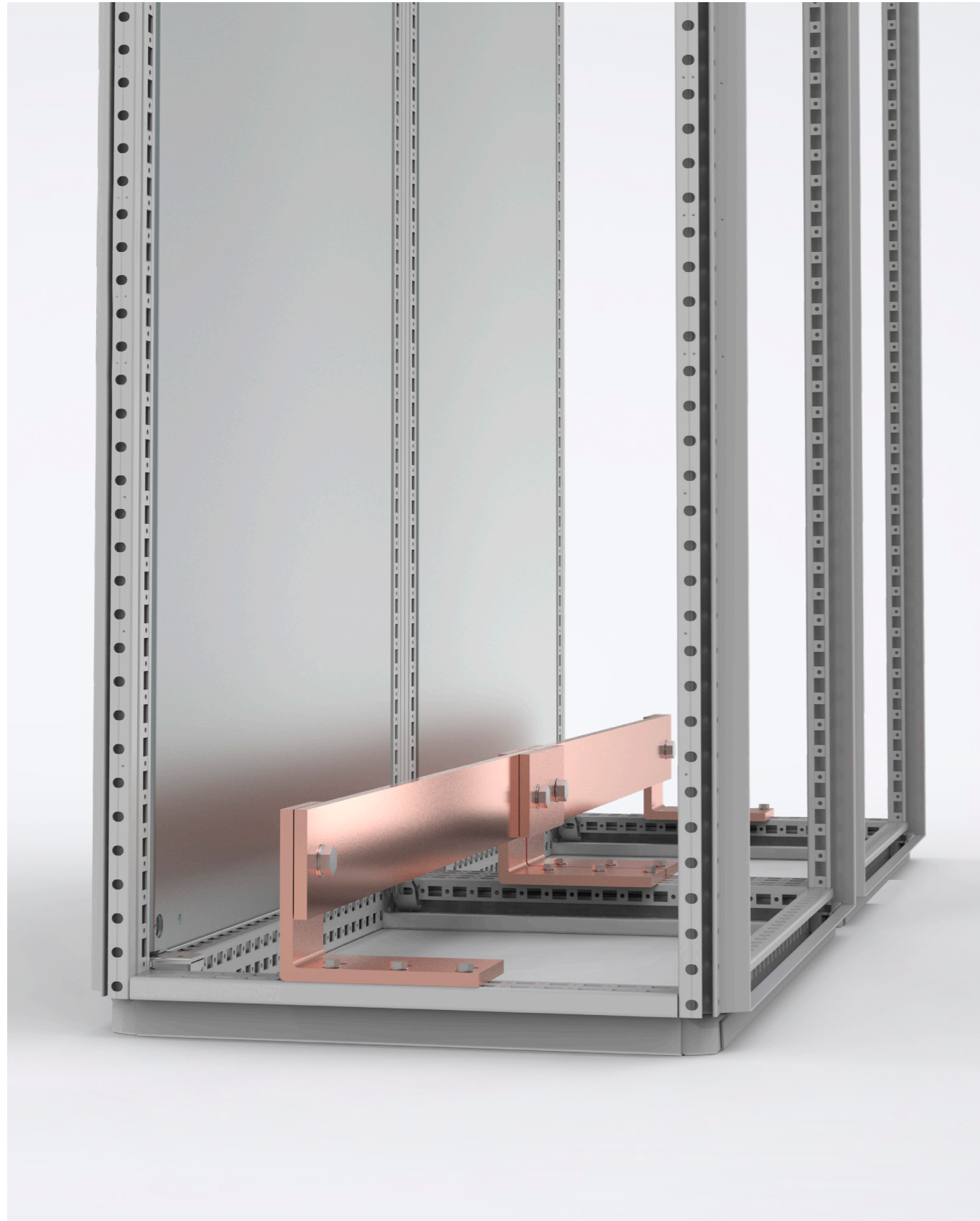

Customer benefits

- Tested solutions
- Wide range of PE accessories
- Designed for nVent HOFFMAN enclosures

Launch date

- Available now

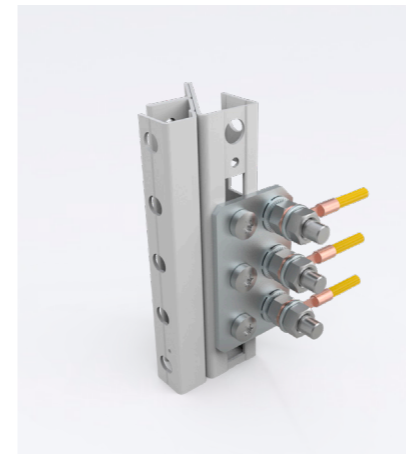

Upgraded earthing portfolio is tested in nVent HOFFMAN enclosures.

Unwanted short-circuits in an automation enclosure or switchgear cannot be completely avoided, despite thorough electrical engineering work. Equipment that may cause short-circuits must therefore be equipped with appropriate short-circuit protection and conduct any short circuit current occurring during the fault duration without impairing safety.

The manufacturer of the switchgear assembly must always ensure that the earthing circuit is able to withstand maximum thermal and dynamic loads occurring at the point of installation.

nVent HOFFMAN's updated earthing portfolio includes provision of relevant data to enable fast and reliable implementation of any adjustments at the project planning stage. Full documentation with test results can be found on nVent's websites. The new portfolio includes new PE busbars, Isolators, earthing fixation points, and a complete range of copper busbars designed and tested for nVent enclosures.

Affected products

ECB, PE / PEN bars

Item no.	Description
ECB043005	Earthing copper bar 30x5x395
ECB043010	Earthing copper bar 30x10x395
ECB044010	Earthing copper bar 40x10x395
ECB048010	Earthing copper bar 80x10x395
ECB063005	Earthing copper bar 30x5x595
ECB063010	Earthing copper bar 30x10x595
ECB064010	Earthing copper bar 40x10x595
ECB068010	Earthing copper bar 80x10x595
ECB083005	Earthing copper bar 30x5x795
ECB083010	Earthing copper bar 30x10x795
ECB084010	Earthing copper bar 40x10x795
ECB088010	Earthing copper bar 80x10x795

ECK, PE / PEN support bracket

Item no.	Description
ECK01	Earthing copper angle 30x5
ECK02	Earthing copper angle 40x10
ECK03	Earthing copper flat 40x10

EBB, PE / PEN baying bracket

Item no.	Description
EBB3005	Earthing baying bracket 30x05
EBB3010	Earthing baying bracket 30x10
EBB4010	Earthing baying bracket 40x10
EBB8010	Earthing baying bracket 80x10

NS, PE / PEN bars

Item no.	Description
NS750	Earthing bar 750mm

TNS, isolator for NS bars

Item no.	Description
TNS2	Earthing bar support for NS750

OKD, connection terminal for NS bars

Item no.	Description
OKD1	Terminal

Others

LED light



Customer benefits

- Fast tool-free assembly with nVent HOFFMAN's quick fixation system
- Easy connection thanks to a plug and play system
- Can be used for voltages between 100-240V (AC) 50/60Hz

nVent HOFFMAN's new enclosure light, EL, is the first light designed specifically for nVent HOFFMAN enclosures.

The new light is equipped with an integrated quick fixation system and can be fitted anywhere in the 25 mm hole pattern in nVent HOFFMAN's profiles without any machining. This makes the light easy to install, which in turn reduces assembly time.

Optional screw and magnetic attachments are available, should any other mounting options inside the enclosure be required.

All connections to the LED light are designed to reduce assembly time. The infeed, through wiring, and door switch connection are all based on a plug and play system. The LED light is suitable for global use thanks to its multi voltage feature 100-240V (AC) 50/60Hz. Models for 24V (DC) are also available off the shelf.

The new LED light is available in many different versions. Versions with the integrated motion detector eliminate the need for an external door switch. Versions with an integrated socket offer a connection for electrical tools, additional lights, and other appliances, when needed for maintenance. The lights are available in several different levels of brightness.

Launch date

- Available now

Affected products

- EL, enclosure LED light
- ELC, connection accessories
- ELD, door-operated switch
- ELA, mounting accessories



Others

Cage nuts



Customer benefits

- Quick fixation to the frame
- Cages and nuts are preassembled
- Available for M6 and M8
- Seismic-proof according to GR-63-CORE, Issue 4

nVent HOFFMAN keeps upgrading its mounting accessories ranges looking for reducing the assembly time even more.

The new quick fixation cage nuts can be installed in the standard hole pattern without tools from the front.

The cage made of polyamide is flexible and easy to install.

Available for M6 and M8, the new cage nuts are suitable for high tightening torque and high tensile forces up to 8 Nm. Moreover, the new design is impossible to over-twist nut and cage, which is perfect for the secure joining of metal accessories.

Going even forward, new design is seismic-proof according to GR-63-CORE, Issue 4, which makes the cage nut the perfect fit even in the most demanding environments.

Launch date

- Available now

Affected products

CNM, cage nuts

Accessories including cage nuts

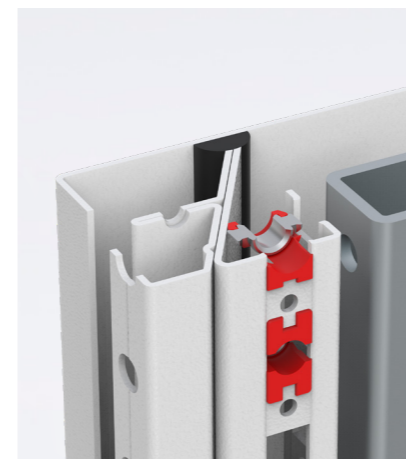

Others

Unibody enclosures, SSFS



Customer benefits

- Seamless foam-in-place polyurethane gasket assures a water-tight and dust-tight seal
- High-impact thermoplastic data pocket provided with each enclosure
- Base plinth (100mm) included with front and rear removable cover for easy cable entry
- Two-door enclosures are provided with a removable center post for easy mounting plate installation

Launch date

- April 2021



Free-stand solutions to meet your Oil & Gas application needs

Unibody enclosures are specially designed for heavy duty applications in which large components or complex mounting configurations must be protected in harsh environments. Three-point latching and sealing provide industry-leading protection from dust, dirt, oil and water.

The enclosure is for housing motor starters, drives, contactors and PLCs, as well as a wide variety of other electrical and electronic equipment. The design with double access is ideally suited for mounting physically large, heavy duty devices where tight sealing (IP) and rigidity (IK) are important.

Affected products

- A**SSFS*, unibody enclosures, stainless steel 304
- A**SS6FS*, unibody enclosures, stainless steel 316
- A**SSTSE, unibody solar shield top, stainless steel 304
- A**SS6TSE, unibody solar shield top, stainless steel 316
- A*P*F1GE, unibody mounting plate
- A*SMP*GE, unibody side mounting plate
- A*SOF19E, unibody swing frame
- A*RA19THE, unibody 19" rack angles
- ALGDSTOP2E, unibody door stop;



Our powerful portfolio of brands:

CADDY ERICO HOFFMAN RAYCHEM SCHROFF TRACER



eldon.com
HOFFMAN.nVent.com