

Modular Solutions For Data Centers





DESIGN WITHOUT LIMITS

MODULAR SOLUTIONS FOR DATA CENTERS

Increased processing capacity, greater efficiency, a smaller physical footprint and reduced operational costs – meet all your goals with the modular data center solutions from nVent.

Made to Measure

PHYSICAL IT INFRASTRUCTURE SOLUTIONS

CHALLENGES AND SOLUTIONS

Higher complexity and thermal loads per cabinet lead to increased cooling and energy requirements. Multi-vendor systems create complexity. New security threats emerge daily. The modular, compatible and scalable nVent SCHROFF product platforms help you achieve your goals and over-come these evolving challenges. We combine our modular components to create tailor-made systems specifically suited to your needs.

THE BASIS FOR THE UPTIME OF YOUR DATA CENTER

SCHROFF Datacom solutions by nVent individually combine modular components and scalable, standard products. They all work together perfectly and create an individual solution attuned to your requirements.

CONTENTS

IT Infrastructure Layouts	4
VARISTAR Server Cabinets	6
Cable Management	8
Doors and Locks	10
Colocation Cabinets	11
Air Management Panels	12
Front-to-Back Cooling	13
Containment	14
Water Cooling	16
Power Distribution and Power Management	18
Monitoring and Remote Management	20
References	22



IT Infrastructure Layouts

INFLUENCED MAINLY BY THE COOLING SOLUTION

SYSTEMATIC APPROACH

In order to meet data center goals and evolving challenges, nVent SCHROFF solutions by nVent take all the critical factors into consideration:

- The speed of technological change has created significant new challenges for the data center
- Increased server processing capacity and smaller physical footprint
- Multivendor systems create complexity and security threats emerge daily
- Greater efficiency and reduced operational costs are required

COOLING ON DEMAND – SCALABLE AND SMART COOLING SOLUTIONS

Devising a reliable concept for the thermal management of a data center is a key function and a major challenge:

- Thermal failure is the root cause of more than 50 % of all equipment failures
- Energy consumption for cooling is a significant proportion of a data center's overall energy footprint and provides options to improve the efficiency
- Cooling has to be aligned with the real heat load of the data center:
 - Heat dissipation has to be planned as accurately as possible (at the beginning, a newly built data center is usually only equipped with 20-30 % of the IT equipment it has been designed for)
 - Performance peaks must be taken into account (in general, more processing power is required during the day than at nighttime or at weekends)

1. CABINETS WITH LOW HEAT LOAD

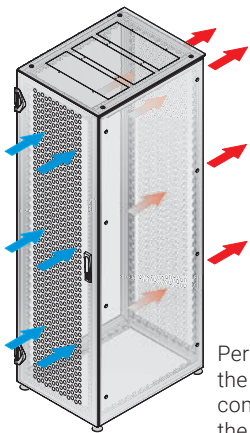

Perforated doors: the fans of the active components drive the air out of the cabinet

2. TOP COVER FAN UNITS



Top cover fan units: draw the heat from the cabinet

3. COLD AISLE CONTAINMENT

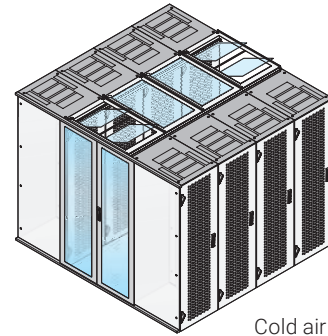

Cold air is supplied through a raised floor, aisle covers and doors prevent cold air leaks

Increasing Packing Density and Redundancy

4. IN-ROW COOLING

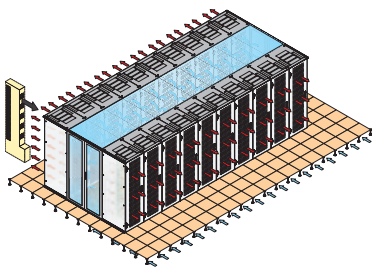

Cold air is provided by an air/water heat exchanger bayed in the cabinet row

5. AIR / WATER HEAT EXCHANGER

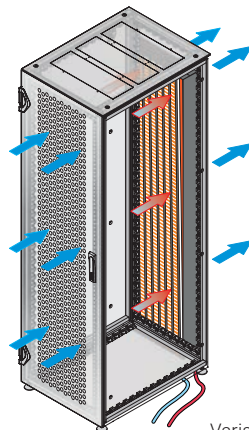

Varistar RDC

6. AIR / WATER HEAT EXCHANGER

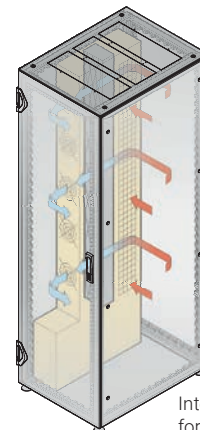

Integrated Heat Exchanger for High Performance Computing (HPC) or closed loop bayed cabinet system

WHICH TYPE OF COOLING IS MOST SUITABLE?

Both for upgrades to existing data centers and for new-build facilities, the choice of cooling depends on a number of factors:

- Energy consumption of individual server cabinets and their configuration
- Quantity and type of servers installed
- Prevailing environmental parameters of the data center
- Required redundancy and uptime level (tier levels)

The following basic rule applies: the higher the power density, the more serious and costly the consequences of poorly designed climate control systems are.

Specialist know-how and the most technically advanced products – always combined with thorough assessment and consultancy – add up to what you expect from nVent: energy-efficient, future-ready solutions – with economic viability built in.

Electronics Packaging at Its Best

VARISTAR SERVER CABINETS

FOCUSED ON FLEXIBLE SOLUTIONS

The more complex and demanding the conditions of your IT infrastructure are, the more you must demand from an individually adjustable server cabinet.

- Flexible platform (dimensions)
- Compatibility of components
- Continual development

With its outstanding characteristics, the Varistar platform will satisfy even the trickiest requirements on loading capacity, cable management, security, thermal limits and energy efficiency.

ROBUST PLATFORM FOR HARSH ENVIRONMENTS

The Varistar platform is available readily equipped for the worst: shock and vibration tested to DL 6 of the IEC 61 587 standard, earthquake resistant up to Bellcore Zone 4, MIL 901D certified and with excellent EMC shielding of 60 dB at 1 GHz.



Electronics Packaging at Its Best

VARISTAR SERVER CABINETS

CONFIGURE AS YOU LIKE

Since every computer room is different, Varistar lets you build the exact solution that is best suited to you from the range of components and covers available. The Varistar range includes more than 1000 parts and components which can simply be combined thanks to our ServicePLUS assembly. Three standard colors - black grey, light grey and white – offer a contemporary, impressive look. Additionally, you can choose your favorite color from a selection of RAL shades. These manifold configurations possibilities make all the difference to a cabinet from stock, without long lead times and unfavorable prices.

FACTS AND FIGURES VARISTAR SERVER CABINETS

Frame:	Load-carrying capacity of up to 1600 kg (3524 lbs)
Dimensions:	Standard models Heights 24 to 52 U Width 600 and 800 mm Depth 600 to 1200 mm
Profile:	Grid holes and meander-type profile with mounting options in all three planes
Doors:	Full doors and double doors with single or 3-point locking, 180° opening left and right (see following page)
Top covers:	Plain, perforated, with cable entry brushes, flat with different cutout zones, raised
Bottom plates:	Without (open), multi-piece, brush strip, blanking plate
Side panels:	Screw-fixed or with quick releases as well as divider panels for bayed cabinets
Security:	Different handles and locking options, also electronic and remote
19" plane:	Recessable in 25 mm increments for server cabinets
Accessories:	More than 1000 parts and components, clear division into cabling zones

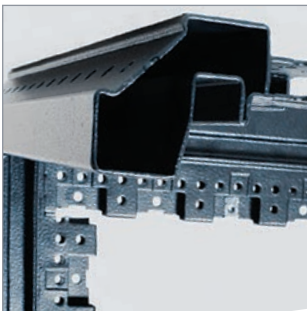

Robust frame for high loads of up to 1600 kg



19 inch cross bar



Large cable entry zones

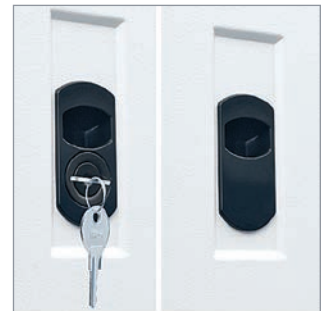

Side panel with quick release

Sophisticated Features

CABLE MANAGEMENT

ESSENTIALS FOR CABLING

- Easy cable routing, additions and changes
- Common cable types such as fiber, CAT 5e, CAT6, CAT 6a and CAT 7
- Cable management to avoid strains, bends and pressure points
- Flexible cable entries and exits which allow space for future cabling
- Designed to support the airflow (structured, no air resistance)
- Separation of data cables from power cables

SECURELY SEPARATED: DATA AND POWER CABLES

Varistar also demonstrates its advantages when it comes to cable management. Four defined zones allow a tidy cabling and the simple, secure fixing of all cable types. For each zone, a specially-adapted accessory has been designed that simplifies cable management for you. And with its numerous mounting options, the Varistar frame emphasizes its good design and its perfect match to data and networking systems.

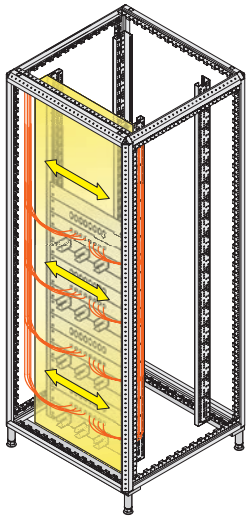

Zone 1: In front of the 19" plane

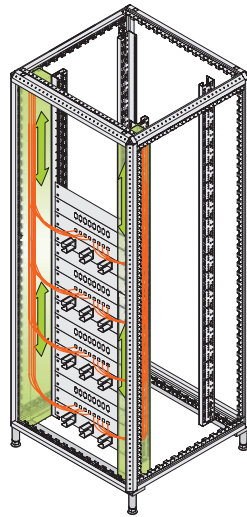

Zone 2: To right and left beside the 19" plane

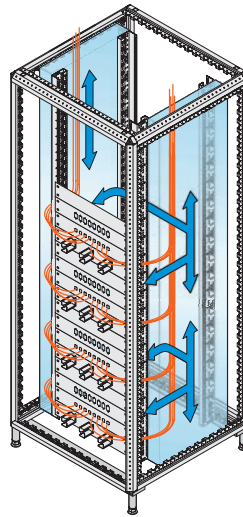

Zone 3: Runs laterally behind the 19" plane throughout the cabinet width

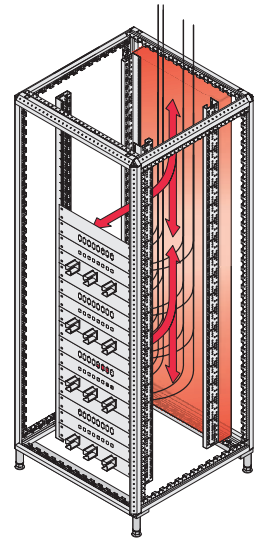

Zone 4: Runs across the cabinet width at the rear

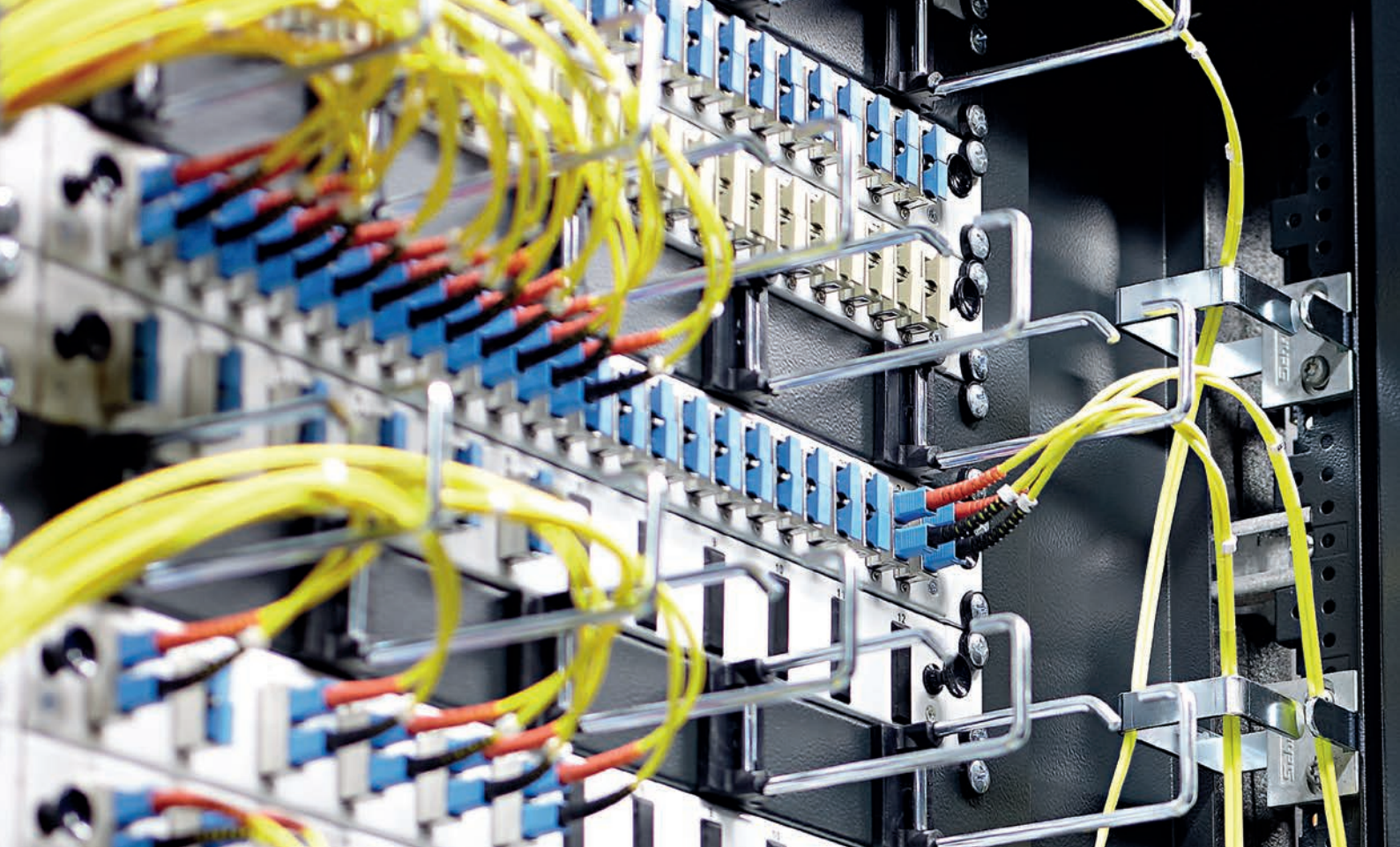

Elaborate Solutions

CLEVER CABLE MANAGEMENT

ACCESSORIES

- Cable eyes made of steel or plastic mounted directly on the meander-type profile frame
- C-rails, cable support rail for cabinet depth and depth member
- Vertical cable trays and cable ladder in the cabinet
- Cable tray support bracket on top of the cabinet
- Vertical and horizontal cable managers with cable finger solutions



Cable management solution with cable fingers



1U 19" panels with cable eyes made of steel or plastic

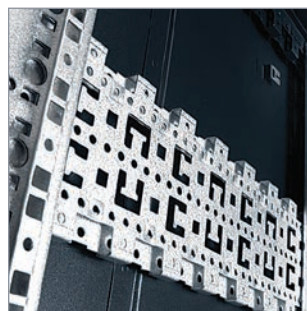

Depth member

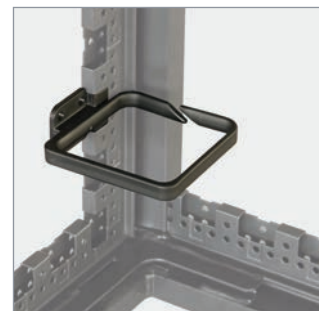

Flexibly applicable cable eyes

Up-to-Date Access Control

DOORS AND LOCKS FOR DATA CENTERS

IMPRESSIVE VARISTAR DOOR OPTIONS

If your focus is on optimum space utilization it would be best to fit your cabinets with double instead of single doors. All doors are equipped with 180° hinges which can be easily mounted either left or right. Open cabinet doors can be removed quickly and simply without tools.

SECURELY CLOSED AND EASILY CONTROLLED

If security aspects are important to you, choose a lockable device from our wide ranging handle program: there's everything from simple lever handles with or without DIN-standard cylinders to IP-addressable electronic handles.



Numeric code lock for simple, easy access control



Electronic handle integrated into the SCHROFF monitoring system or connected to external (biometrical) devices



All doors are equipped with 180° hinges



Electronic handle MLR series; stand-alone or networked transponder card version with handle management software



Accessibility Assured

MULTI-COMPARTMENT COLOCATION CABINETS

SECURITY AND ACCESSIBILITY UNITED

nVent has standardized a broad portfolio of nVent SCHROFF colocation cabinets. The special focus of the design was to ensure access security when several customers are sharing the same multi-compartment cabinet.

- Cabinet with 2, 3 and 4 compartments
- 600/800 mm wide, 1000/1200 mm deep cabinets in 42/52 U
- Shelf divider, attached to the frame at multiple points, also serves as cable tray for easier cable management
- 2-point door latching system adds to security
- Individual combination locks or electronic locking options
- Cable entry from top and bottom as well as from left and right
- A bottom plate that can be mounted from inside the cabinet facilitates the cable ducting from the raised floor

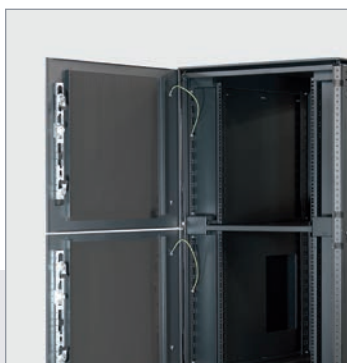

2-point locking system

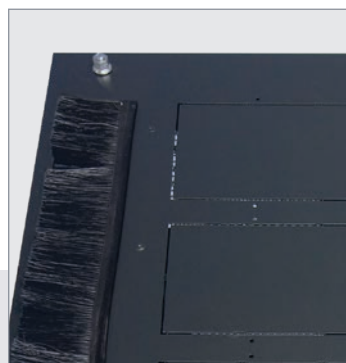

Cable entry zones in top cover



Shelf divider and compartment cable entry

Essential for Your Uptime

AIR MANAGEMENT PANELS

IMPROVE THE EFFICIENCY OF YOUR DATA CENTER

Vast amounts of energy are used to move and cool the air to the required temperature level. The cooled air is directed exactly to where it is needed: towards the air intake areas of servers and applications.

- Avoid any air resistance and ensure a barrier-free passage for the air, thus reducing the required fan speed for moving the air
- Separate cold from warm air, otherwise recirculation will force you to cool the air more than necessary

A CLOSED SYSTEM SAVES ENERGY

For every one degree Celsius the air inside a data center does not have to be cooled, approximately 4 % energy outlay can be saved. Hence it is essential to close open rack units (U) and the zone adjacent to the 19" plane. The only open space should be the air intakes for the applications. The data center owner, however, will also have equipment, especially switches, that require front to back cabling. With its flexible SCHROFF standard panels, nVent meets both requirements.

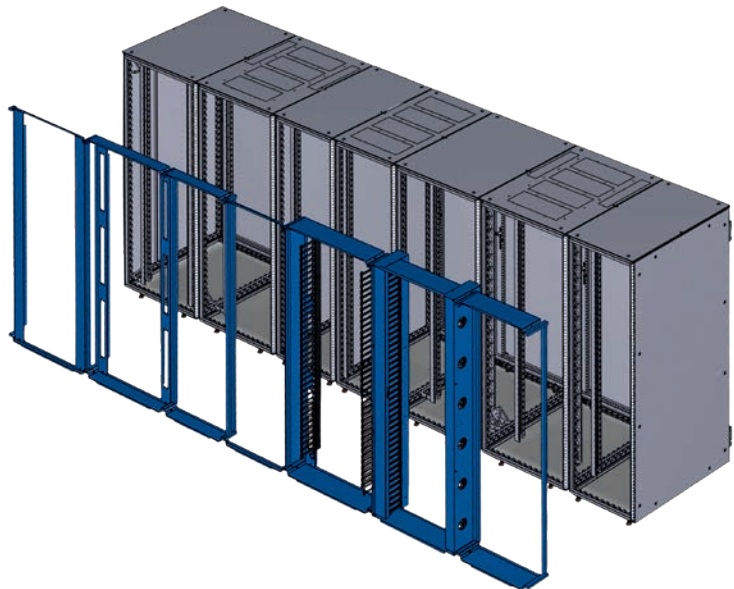

Essential for Your Uptime

AIR MANAGEMENT PANELS

SOLUTION FOR SIDE-TO-SIDE COOLED SWITCHES

Once the cabinets have been optimized for front-to-back cooling, an additional challenge may arise: some switches may require side-to-side cooling, or even worse, a combination of front-to-back and side-to-side cooling, and always in combination with front-to-back cabling.

To meet this challenge, nVent offers a special side-to-side air panel kit. The kit can be retrofitted in an already bayed cabinet.

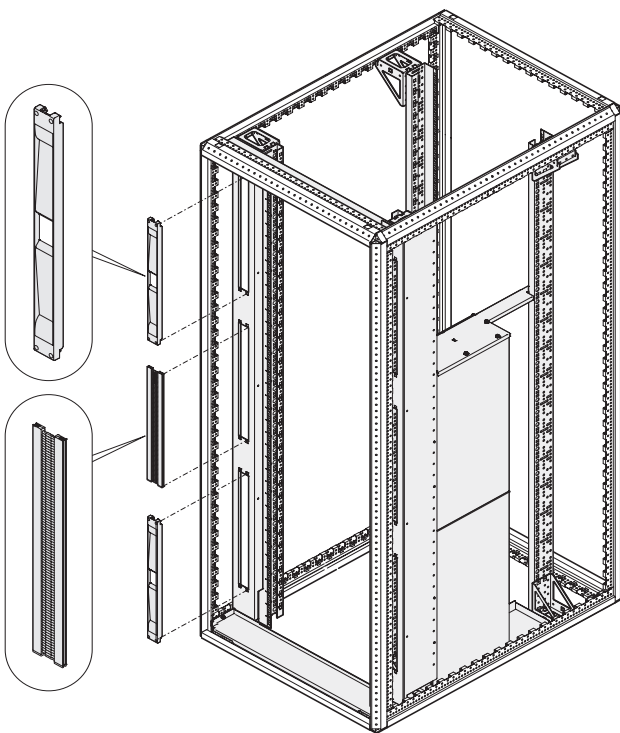

Special side-to-side air panel kit: right hand side for air intake, panels guide the air through the switch; the left hand side is prepared for front-to-back cabling; gaskets can be easily cut to the required length

PANELS FOR FRONT-TO-BACK COOLED CABINETS

- Easy recessment
- Networking cabinet can be mounted side-to-side with server cabinets
- Options to duct cables transversely in the cabinet
- Cables can be ducted from cabinet to cabinet
- Cable finger versions for cable management
- All panels are delivered with gaskets to reduce air volume losses

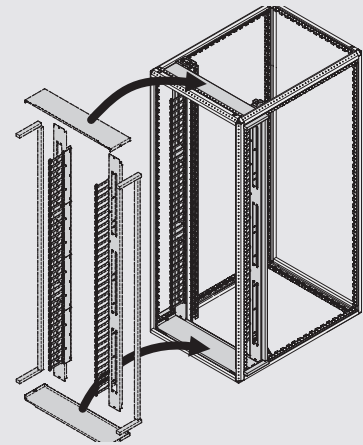

Standard panel with cable through-ducting and cable fingers



1 U plastic front panels



Clip-on 6 U plastic front panels

Separation Saves Energy

CONTAINMENTS, DOORS, TOP COVERS



FOR ENERGY SAVINGS OF UP TO 30%

nVent's analysis of cold and warm aisles without containment shows that a 12.6°C output temperature at the computer room's air conditioner (CRAC) is required in order to provide a temperature of 25.6°C to the servers mounted in the upper part of a cabinet.

To achieve further efficiency improvements a data center should be designed as aisle containment, separating warm from cold air. By using the nVent SCHROFF standard containment

system in combination with air management panels, air volume losses in the data center can be reduced to practically zero. The immediate advantages:

- No thermal layers in front of the 19" plane inside the containment: all servers have the same intake air temperature.
- Overpressure in the contained aisle: the blow-in temperature of the CRAC is almost the same as the temperature in front of the servers

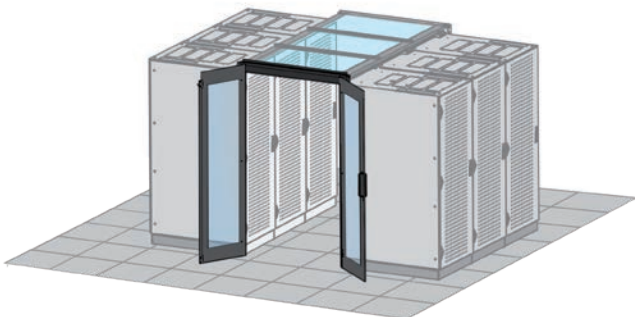

Swing doors

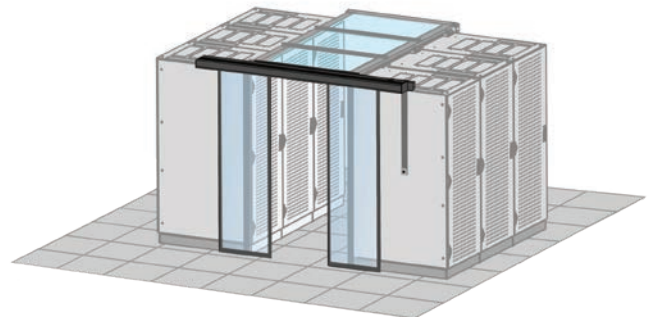

Automatic sliding doors: can be combined with electronic locking options and integrated into the nVent SCHROFF monitoring system

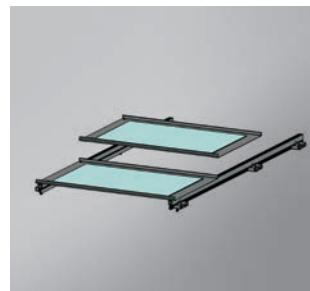

Top covers with universal profiles

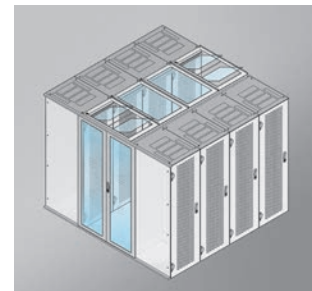

Electrically-opening top cover

Thus, it is no longer necessary to overdo cooling, especially at the CRAC, allowing a temperature optimization and energy savings of up to 30 %, proven with “before” and “after” measurements in customer data centers. The comparatively small investment in mechanical panels and containment parts offers a short ROI and no OPEX for maintenance.

STANDARD CONTAINMENT SYSTEM

In addition to their functional aspects, the doors are the “face” of the containment. Besides defining the aesthetics of the system they also have a security function. With the appropriate access control system, cabinet doors inside the aisle are no longer necessary, which also minimizes air resistance. Depending upon room space, security and functional requirements, nVent offers a broad range of maximum sized safety-glass containment doors adding to more security.

FLEXIBLE SOLUTIONS FOR AISLE COVERS

nVent SCHROFF containment top covers are made of laminated safety glass which provides a major advantage over plexiglas in terms of fire rating, sensitivity to scratching and stability. The steel frame provides space to house fire extinguisher injectors or smoke sniffer systems. If required, nVent can offer electrically-opening top covers. These top covers can be integrated into the nVent SCHROFF monitoring system or a building management system, and open to user-defined alerts.

The universal profile of the covers gives more flexibility and functionality to the containment system. With a length of 2400 mm, 3 to 4 cabinets (depending on cabinet width) can be covered.

The cover system also allows to integrate OEM cabinets into a row of Varistar cabinets. When optimizing existing IT infrastructures by retrofitting a containment system, the universal profile also carries the top covers and bridges different heights of cabinets.

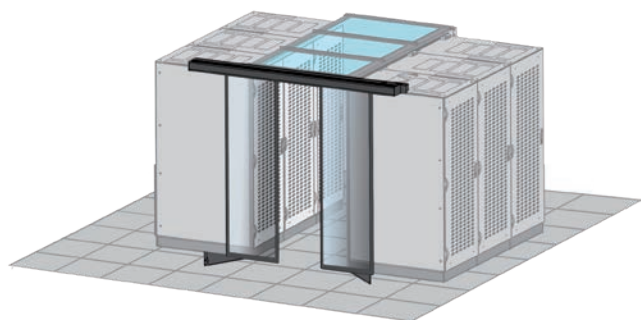

Manual sliding doors

Keep Cool

THE BEST WATER COOLING TECHNOLOGY



AIR TO WATER COOLING – HEAT EXCHANGERS

As the heat load footprint steadily increases, traditional cooling methods are reaching their physical limits. When designing a data center, heat load limits per cabinet might arise which in turn would lead to unused rack units.

The solution: air/water heat exchangers installed closer to the heat source, not only increase the cooling capacity per rack but also improve the redundancy of the data center. With intelligent controls, cooling units can react quickly to the workload of the equipment, thus offering additional savings.

When installing air/water heat exchangers, raised floors are no longer needed, thus again achieving investment savings. Hot-swappable fans as well as redundant power supplies offer you security and guarantee system uptime.

REAR DOOR HEAT EXCHANGERS

The passive heat exchanger is positioned inside the back door of the cabinet and cools the exhaust air before it flows back into the room. Thanks to the large surface, high cooling capacities of up to 50 kW can be reached with this completely passive system.



Varistar RDC

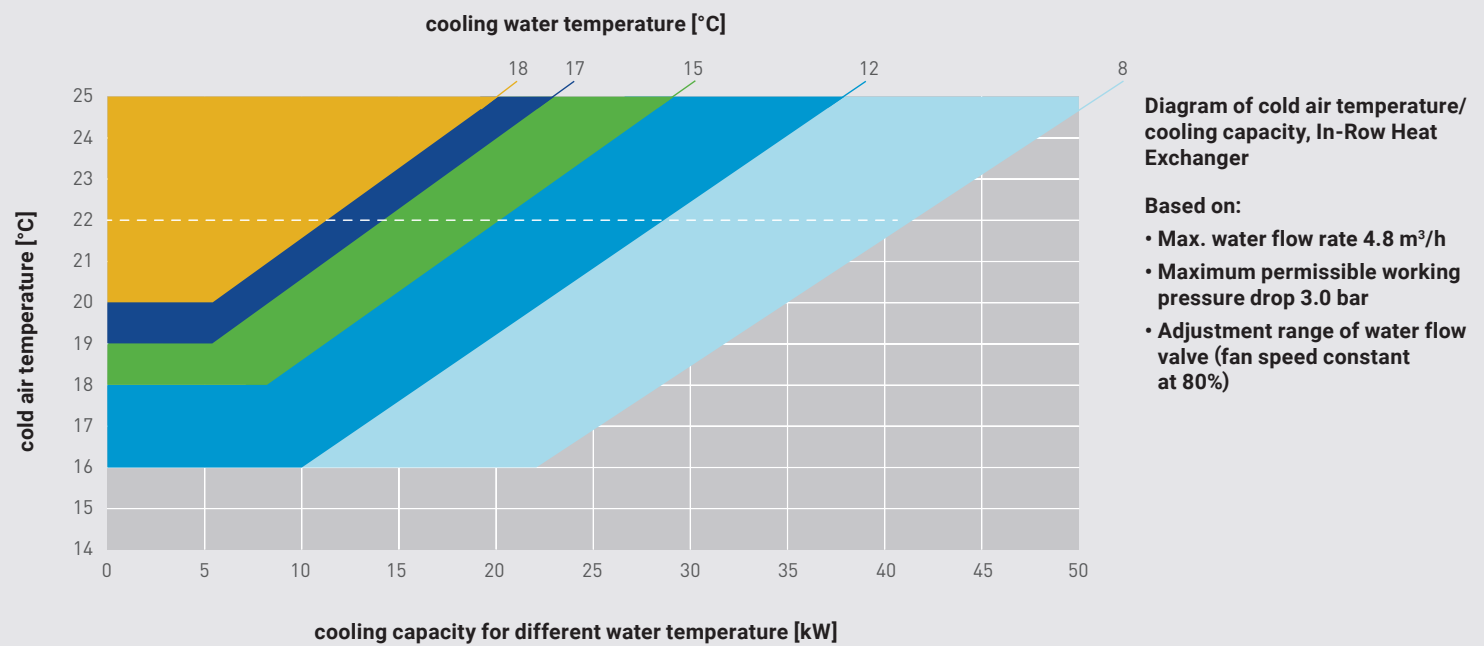

VARISTAR LHX+ SERIES

Rack integrated active heat exchanger. Integrated into a 800 mm wide cabinet, it offers the smallest footprint on the market. The closed loop system reduces the noise level and is self-controlled by the heat load. With a maximum cooling capacity of up to 40 kW it is suitable for HPC applications.

Several cabinets can be bayed to form a closed system. Small footprint, low noise level and easy implementation of redundancy make it attractive for medium size data centers.



Bayed cabinets with integrated Heat Exchangers

IN-ROW HEAT EXCHANGERS

Active heat exchanger for containment systems with a cooling capacity of up to 30 kW. The cooling unit is bayed in a row of contained cabinets. This offers optimal scalability regarding required cooling capacity and redundancy planning of the system.



In-Row Heat Exchanger

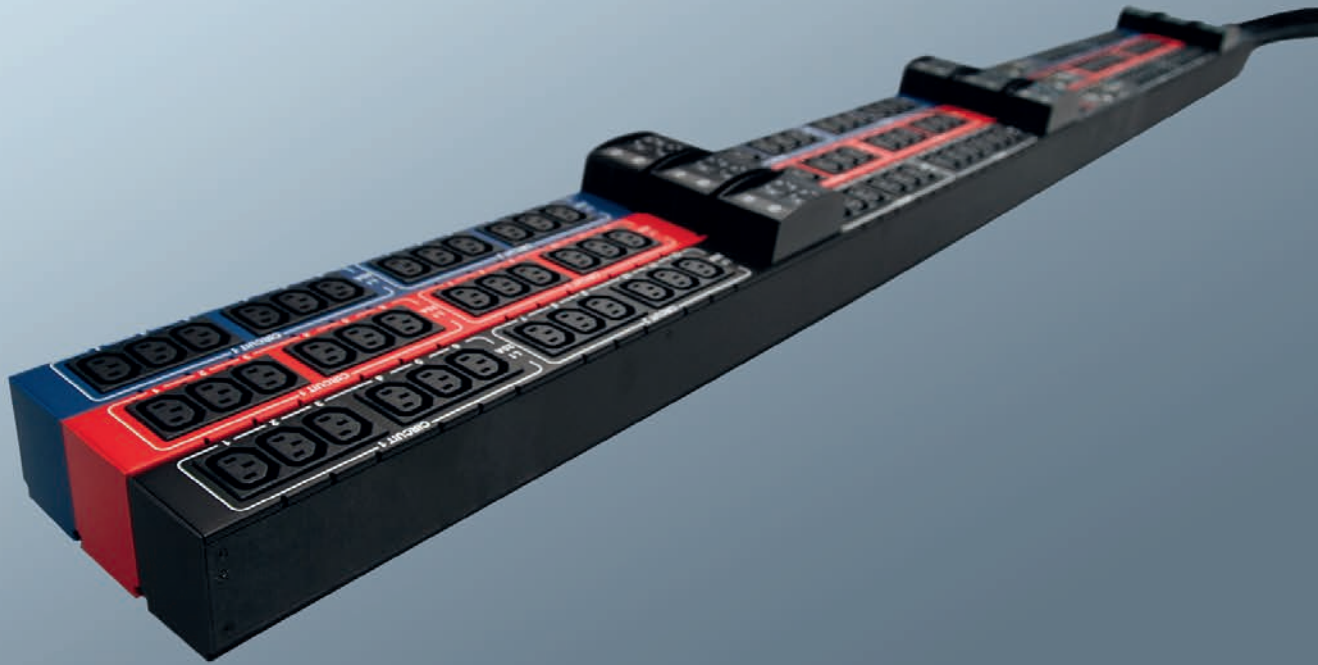

Power Under Full Control

POWER DISTRIBUTION AND POWER MANAGEMENT

REDUCE THE POWER CONSUMPTION

Power supply and distribution systems are among the most important elements in any server cabinet. Power resources become increasingly constrained and the cost of energy is spiraling out of control. As a result, data centers all over the world are approaching operational capacity limits. Taking these aspects into consideration, nVent offers a wide range of helpful options. In nVent's concept, the individual components can be combined to outstanding effect.

- Improving server uptime and reliability
- Allowing higher rack densities
- Reducing capital expenditures and saving on operating expenses
- Measuring real-time PUE (power usage effectiveness)

nVent offers appropriate solutions to face these challenges:

- Basic PDUs (power distribution units)
- Intelligent PDUs with rack-level remote power metering and monitoring
- Intelligent PDUs with circuit-level/line-level remote power metering and monitoring
- Intelligent PDUs with rack-level and outlet-level remote power metering, monitoring and switching

CONTROLLING POWER – THE ADVANTAGES

Whether you need basic, single or three-phase power distribution or a power management solution providing highly accurate, detailed information, achieve greater control of your data center by:

- Making informed decisions with regard to capacity planning
- Using the power you have more efficiently

INTELLIGENT POWER DISTRIBUTION UNITS FOR MONITORING AND REPORTING

All nVent Intelligent Power Distribution Units (I-PDUs) offer plug-and-play environmental monitoring capabilities as well as the highest security features. By combining your I-PDUs with Power IQ® energy management software, it is possible to monitor and report energy usage and environmental conditions at any level – data center, rack, department, equipment type – from a user-configurable centralized dashboard. It also provides email notifications, outlet control, power cost analyses, line capacities, carbon footprint and rack temperature.

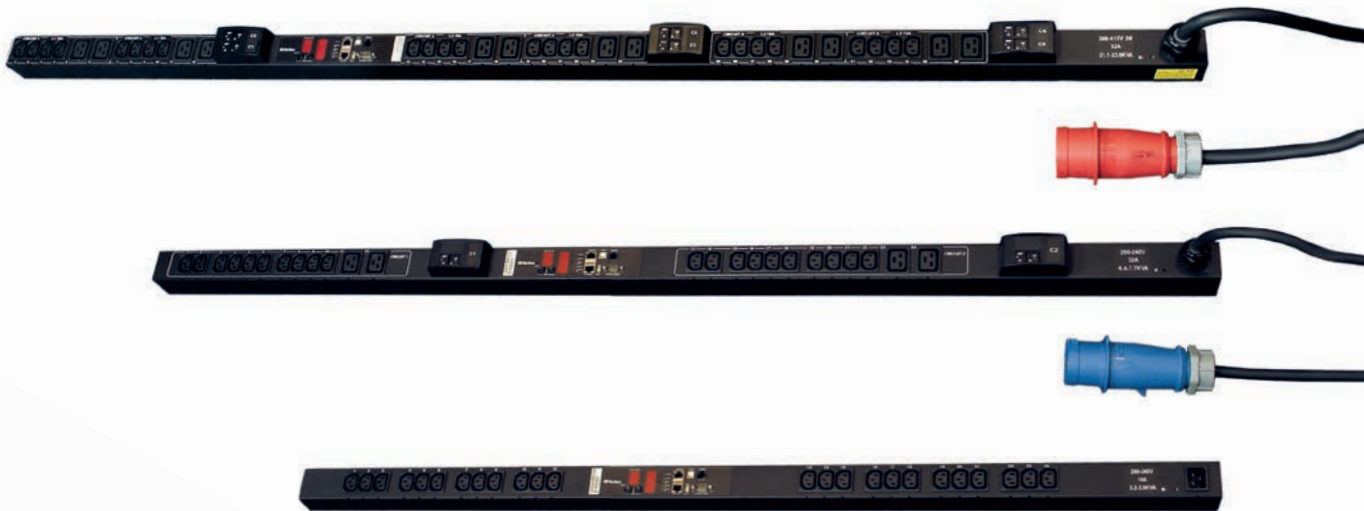

Intelligent Power Distribution Units

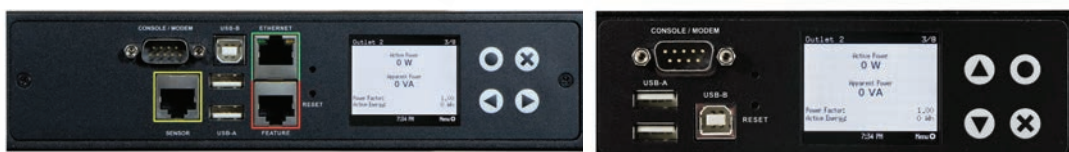

Interfaces and connections in intelligent Power Distribution Units

Measure to Control

MONITORING AND REMOTE MANAGEMENT

DATA CENTERS LIVE AND CHANGE

New technologies create great opportunities for IT – but in turn rapidly increase the complexity of the physical infrastructure. Non-professional installations, hardware failure, infrastructure changes and environmental effects immediately impact the availability and functionality of the data center. For trouble shooting and diagnostics, it is essential for the data center manager to monitor critical parameters.

nVent offers monitoring devices for both single cabinets and cabinet rows with a broad range of plug-and-play environmental sensors. They control all crucial parameters such as temperature, humidity, door contact, smoke, airflow, pressure, water leakage and webcam surveillance.

ALL COMPONENTS ON ONE SCREEN: COOLING, ENVIRONMENT, POWER AND ACCESS CONTROL

By using the plug-and-play connection, it is possible to monitor and parameterize nVent SCHROFF air/water heat exchangers via the device. Operating parameters are easy to set and temperature, fan speed and failure logs can be managed remotely.

With an external contact closure sensor, it is even possible to manage and control electronic cabinet handles or for emergency actions such as opening doors automatically.

When power management with I-PDUs is implemented, no extra monitoring device is required, because all sensors and heat exchangers can be connected to the I-PDUs.

The nVent SCHROFF monitoring system enables you to set your critical thresholds, alerts and automatic event-based actions on rack and data center level.

Guarantee system uptime, increase efficiency by optimizing operating and environmental parameters and ensure access control to your data center by centrally managing and controlling all critical infrastructure parameters.



EMX888 management system for a row of cabinets with up to 8 control sensors and up to 8 water-cooled heat exchangers



EMX111 management system for single cabinet



Temperature sensor



Differential pressure sensor



Contact sensor



Cascaded sensors



Sensor hub



Airflow sensor

Your Global Partner

SOME OF OUR DATA CENTER REFERENCES

TRUSTED DATA CENTER SOLUTIONS

Whatever challenges you have to overcome, together we will find the perfect modular solution for your data center. Our products are the result of our experts' know-how in integrating mechanics, electronics and climate control. Wherever you are: trust in our many years of experience with the widest range of application requirements.



FRANCE



Advanced Physics

GERMANY



Advanced Physics

NORWAY



Energy Provider

RUSSIA



Telecommunication

AUSTRIA



University

UNITED ARAB EMIRATES

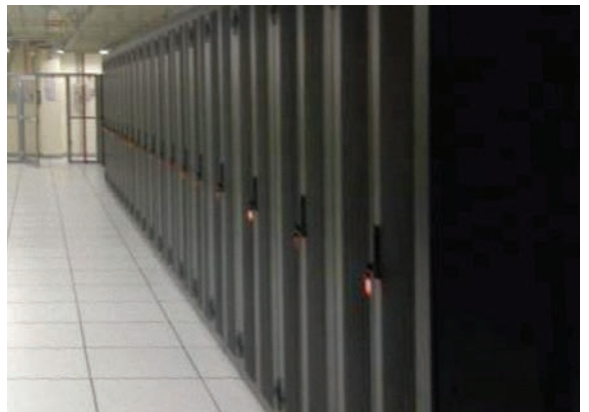

Hosting Provider



Europe

Straubenhardt, Germany	Tel: +49 7082 794 0
Betschdorf, France	Tel: +33 3 88 90 64 90
Warsaw, Poland	Tel: +48 22 209 98 35
Hemel Hempstead, Great Britain	Tel: +44 1442 24 04 71
Assago, Italy	Tel: +39.02.5776151.224

North America

All locations	Tel: +1-800-525-4682
---------------	----------------------

Middle East & India

Dubai, United Arab Emirates	Tel: +971 (4) 823.8666
Bangalore, India	Tel: +91.80.6715.8900

Asia

Shanghai, China	Tel: +86 21 2412 6943
Qingdao, China	Tel: +86 523 8771 6101
Singapore	Tel: +65 6768 5800
Shin-Yokohama, Japan	Tel: +81 45 476 0271



Our powerful portfolio of brands:

CADDY ERICO HOFFMAN ILSCO RAYCHEM SCHROFF