

HF Frame Type Plug-In Unit Rear Panel, Without Cut-Out, 3 U, 28 HP

CATALOG NUMBER

30809-640

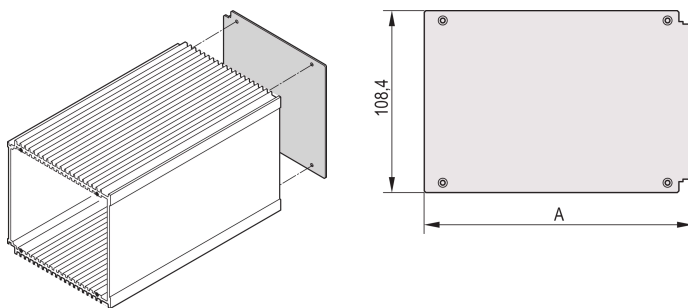

Rear Panel for HF frame type plug-in unit, without cut-out enable a user to created their one cut out.

CERTIFICATIONS



FEATURES

Rear Panel for HF frame type plug-in unit, without cut-out

Rear Panel for HF plug-in units can be modified with Front Panel Configurator

PRODUCT ATTRIBUTES

Rack Width: 28HP

Package Quantity: 1

Material: Aluminum

Product Type: Side Panel

Type: Rear Panel

Works With: Frame Type Plug-In Unit

Gross Weight: 0.063kg

ADDITIONAL PRODUCT DETAILS

Rear Panel for HF plug-in units can be modified with Front Panel Configurator.

Please take into consideration that deliveries may be carried out in the stated SPQs (SPQ, e.g. 5 pieces, 10 pieces, 50 pieces, etc.). Differing order quantities (e.g. 2 pieces) may be changed to the next possible delivery quantity = Standard Pack Quantity.

DIAGRAMS

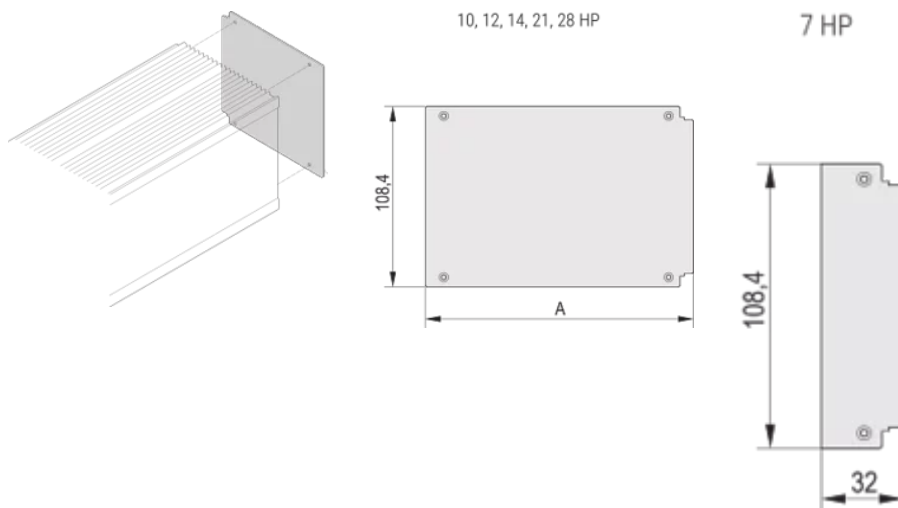

WARNING

nVent products shall be installed and used only as indicated in nVent's product instruction sheets and training materials. Instruction sheets are available at www.nvent.com and from your nVent customer service representative. Improper installation, misuse, misapplication or other failure to completely follow nVent's instructions and warnings may cause product malfunction, property damage, serious bodily injury and death and/or void your warranty.

North America

All locations
+1.763.422.2661
Chat with us:
nvent.com/schroff

Europe

Straubenhardt, Germany
+49.7082.794.0
Betschdorf, France
+33.3.88.90.64.90
Warsaw, Poland
+48.22.209.98.35
Assago, Italy
+39.02.932.7141
Chat with us:
nvent.com/schroff

Asia

Shanghai, China
+86.21.2412.6943
Qingdao, China
+86.532.8771.6101
Singapore
+65.6768.5800
Shin-Yokohama, Japan
+81.45.476.0271
Chat with us:
nvent.com/schroff

Middle East & India

Dubai, United Arab Emirates
+971.4.378.1700
Bangalore, India
+91.80.6715.2001
Istanbul, Turkey
+90.216.250.7374
Chat with us:
nvent.com/schroff



Our powerful portfolio of brands:

CADDY ERICO HOFFMAN ILSCO SCHROFF TRACHTE