

# Advanced Physics and Research Centers

Rack and enclosure solutions





# Meeting the Needs in Scientific and Laboratory Applications

When organizations join forces to invest significant resources into groundbreaking, large-scale Big Science research projects, they need experienced solution providers who understand what's at stake – and how to safeguard critical communications and electronics systems.

## BIG SCIENCE PROJECT

The technologically advanced infrastructures of these critical scientific applications – including particle accelerators, astrophysics, plasma fusion sources and many more – demand cutting-edge precision and reliability spanning:

- Strict requirements for integration density, data throughput and latency
- High-quality hardware that helps ensure stable operation of the control and data acquisition systems
- Real-time motion control systems with advanced synchronization, rear I/O, high availability, redundancy and remote management capabilities
- And more!

For high-end test applications, the nVent SCHROFF brand offers proven expertise and superior products - from electronics cabinets, enclosures and embedded systems to robust solutions for cooling, and shock and vibration resistance.



Hubble Space Telescope, U.S., Europe

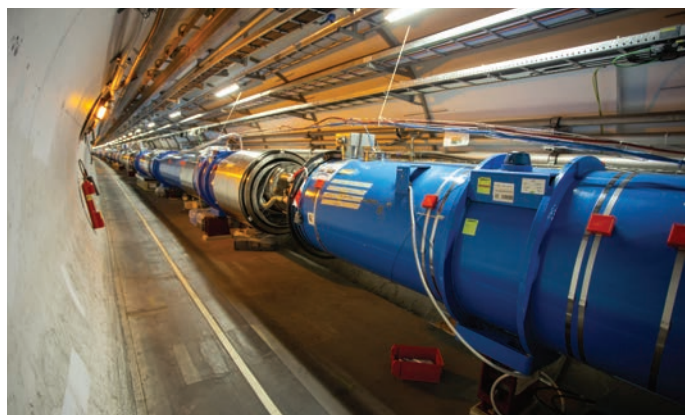

CERN, Switzerland



European Spallation Source (ESS), Sweden



Deutsches Elektronen-Synchrotron DESY, Germany

# Compatible. Modular. Scalable.

Count on faster time to market, while enabling your world-class engineers to build and protect unique measurement, diagnostic and control systems. From single components to integrated systems to fully integrated cabinets, take advantage of our modular solutions.

- Comprehensive standard 19" subracks, systems and cabinets
- Cooling solutions (including liquid cooling) on crate, cabinet and containment level, including sensors and management components to meet tight temperature tolerances
- Open Standard backplanes with superior signal integrity for highest data transfer rates
- Full range of engineering services along with global and local support and production to save time and money



## COMPREHENSIVE SUPPORT

Gain efficiencies and streamline your project management needs. We offer **end-to-end services and support**, including electronic and mechanical design, system management, simulation tools, testing and inhouse production capabilities.



## THE HIGHEST STANDARDS FOR SUPERIOR QUALITY

Recognized worldwide, nVent SCHROFF products meet national and international standards for electronics packaging and comply with **IEC 60297-3-x** and **IEEE 1101.x**. We also offer a broad range of **EMC, IP/NEMA** as well as **NEBS/Seismic** rated cabinets.

Plus, we help set and sustain global standards:

- Standard committee member of **IEC, IEEE, PICMG**
- Active membership in **MicroTCA.4** and **AdvancedTCA** for advanced physics specification work



## RELIABLE ENVIRONMENTAL PROTECTION

Ensure the highest availability at minimal operational costs for systems, subracks and cabinets. Rely on our state-of-the-art environmental protection solutions for your critical components and ensure **cooling, EMC shielding, and shock and vibration proof**.



## WORLD-RENOWNED EXPERTISE

Our **integrated solutions and engineering services** already are connecting and protecting some of the world's most renowned systems, used in advanced physics and scientific projects.

- European Organization for Nuclear Research (**CERN**), Switzerland
- Deutsches Elektronen-Synchrotron (**DESY**), Germany
- European Spallation Source (**ESS**), Sweden
- **SPRING-8** Super Photon ring-8 GeV, Japan
- Lawrence Berkeley National Laboratory (**LBNL**), United States



# Comprehensive 'Big Science' Solutions

Example: Accelerator infrastructure

**SOURCE**  
Provides initial  
acceleration



**ACCELERATOR**  
Accelerates particles  
to almost the  
speed of light

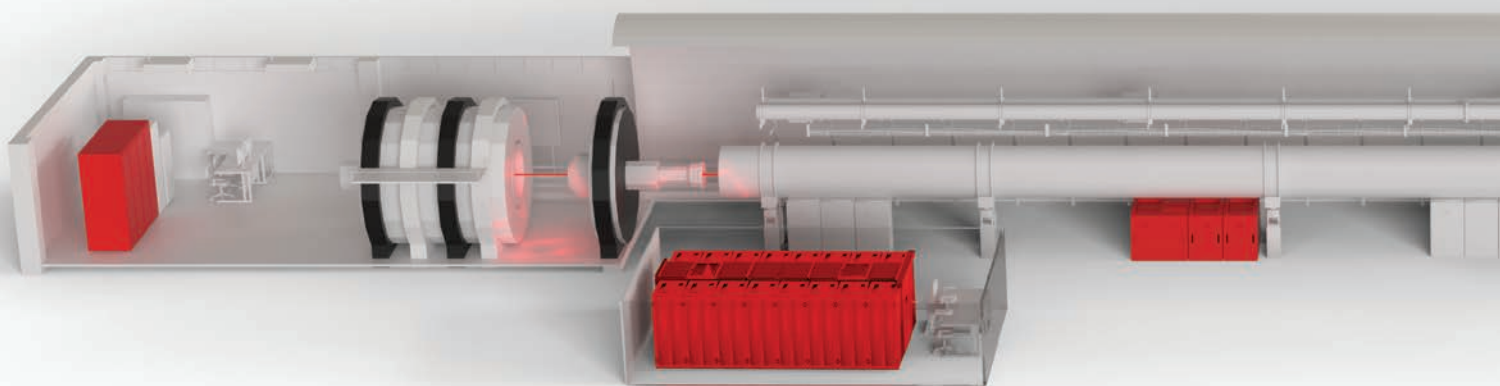

## INSTRUMENT CONTROL SYSTEMS

Equipment for LLRF control, beam diagnostic, beam monitoring systems

## nVent SCHROFF portfolio of products at a glance



nVent SCHROFF xTCA, PXIe and CPCI Serial crates connect and protect data acquisition and control systems.



nVent SCHROFF racks and cabinets provide IP and EMC protection for instrument control systems.



nVent SCHROFF cooling solutions help ensure precise function of the electronics used for data acquisition (DAQ) and low-level RF systems (LLRF).

You can rely on the nVent SCHROFF comprehensive portfolio of products to cool and protect your critical electronic and electrical equipment.

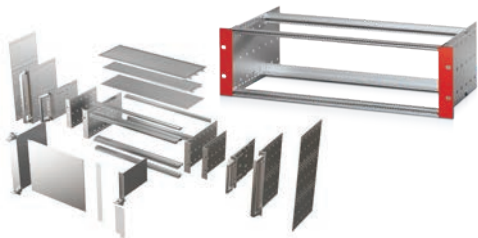
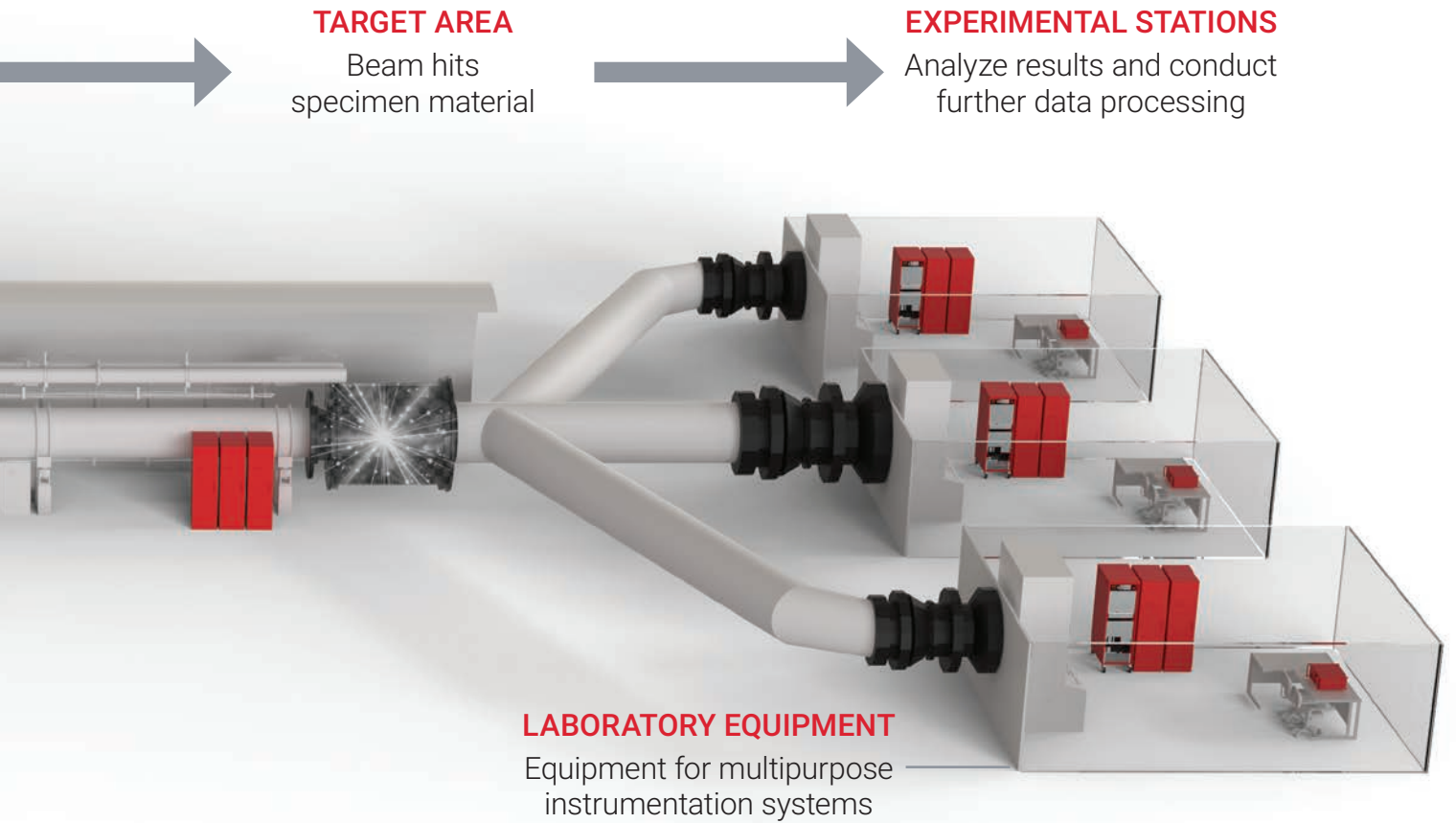

19" subracks as reliable and proven platform for modular systems solutions.

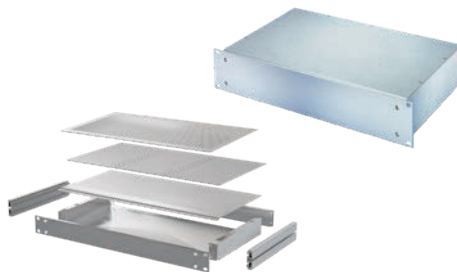

19" chassis to house power supplies, switches, proprietary and other electronics.

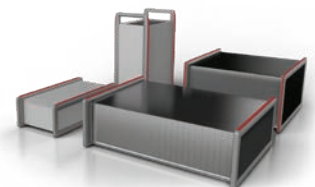

19" and SFF cases for desktop applications, providing superior protection and high degree of flexibility.



# Varistar Electronics Cabinets for Maximum Reliability

Depending on your application, your cabinet may house a variety of critical equipment – such as power supplies, control systems, high-voltage systems, data acquisition systems and monitoring systems – all of which require reliable protection, including EMC shielding and ingress protection against dust, moisture and water.

The designs of nVent SCHROFF Varistar cabinets are based on a welded frame construction, and their modularity ensures the highest flexibility on a single platform. At their core, they feature robust steel profiles, allowing a great range of applications. Their frame meets requirement classes up to DL6 in accordance with IEC 61587-1 and support static loads up to 1,600 kg (3,500 lbs.)

## ROBUST DESIGN

The robust frame was specially designed for high dynamic load requirements and regions susceptible to earthquakes. Dynamic tests verify earthquake protection to Zone 4, providing reliable protection anywhere in the world.



## HF SHIELDING

The nVent SCHROFF Varistar shielding principle protects sensitive electronics from interference radiation. Tested to IEC 61587-3.

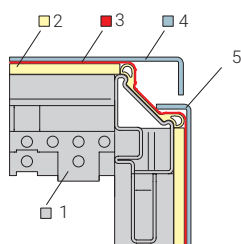

1. Frame
2. Conductive EMC textile gasket
3. Contact/shielding
4. Rear panel
5. Side panel

## IP PROTECTION

Varistar also demonstrates its features best in demanding industrial environments. High mechanical robustness, dust and water seals, and compliant grounding guarantee the operating safety of machines and systems.



## MONITORING

For monitoring options, rely on our products and solutions to measure and monitor your application's operating parameters, such as temperature or humidity, to control fans or heat exchangers, or to detect smoke.



Features	Standards	Results
Static load	Internal load testing and measurement of deformation	1.600 kg (3,500 lbs) (tested with 2000 kg (4400 lbs), safety 25%)
Dynamic load	IEC 61587-1 and internal testing	Static load of 1,600 kg (3,500 lbs) and 1,000 kg (2,200 lbs) dynamic load with integrated castors
Shock test	IEC 61587-1	Maximum acceleration: 5 g duration: 11 ms
Vibration test	IEC 61587-1	Frequency: 5 Hz - 100 Hz acceleration: 1 g
Earthquake test	IEC 61587-2 GR-63-CORE	Bellcore Zone 3 (acceleration 3 g, frequency 1 Hz ... 5 Hz) with strengthening up to Bellcore Zone 4 (acceleration 5 g, frequency 2 Hz ... 5 Hz)
Electromagnetic compatibility (EMC)	IEC 61587-3	60 dB at 1 GHz, 40 dB at 3 GHz
Type of protection	DIN VDE 0470 EN 60529	IP20 and IP55
Installation options	IEC 60297-3-100 ETS 3000-119-3	19" or ETS

# Cabinet Cooling for Maximum Performance and Uptime



Because instrumentation controlling particle accelerators often only allow a temperature fluctuation of  $\pm 0.1$  K within the cabinet, it is recommended to use an air/water heat exchanger.

To effectively cool installed electronics, we offer a variety of cooling options for nVent SCHROFF Varistar cabinets, including air-filtered fans, fan trays, controlled airflow systems, as well as air/air or air/water heat exchangers and compressor-driven air conditioners.

We can help you identify and develop the solution you need, based on the amount of heat generated, internal and external temperatures, and crate setup.

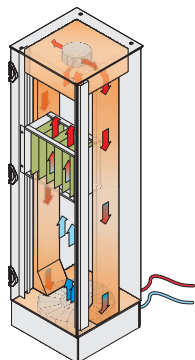
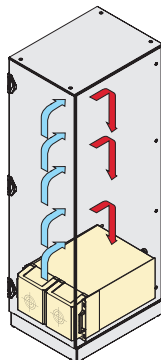
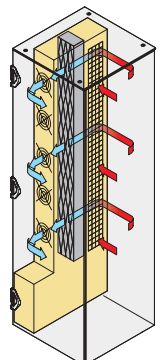
	LHX 3	LHX 5 - 10	LHX 20 - 40
Cooling concept	Bottom to top with heat exchanger on bottom and fan unit on top	Front to back with heat exchanger on bottom and controller unit on top	Front to back with heat exchanger on the side
Space	5 U (heat exchanger) + 1 U (fan unit)	6 U (heat exchanger) + 1 U (control unit)	Does not consume space in 19" rack but adds space on the side
Cooling capacity	1 – 3 kW	5 – 10 kW	+ 20 kW
Temperature control	No	Yes	Yes
Crate set-up	Mounted in plinth	Mounted on 19" frame	Mounted on the side
Application	Suitable for heat sensitive equipment, such as spallation neutron source device, advanced light source laboratory, engine and transmission test bench, etc.		Suitable for equipment applications with high thermal loads, such as in data centers
			

# Open Standard Technologies Systems

**AdvancedTCA (ATCA), MicroTCA (MTCA), CompactPCI Serial (CPCI-S) and PXIe are the serial communication platforms available to support immensely complex accelerator controls and large high-bandwidth, high-throughput experimental data acquisition systems.**

Defined to international standards, the open system architecture is comprised of a chassis with a backplane, a power supply, cooling provision and hardware management. Its modular design allows the use of electronic extension boards. These boards are plugged into the backplane and interface with the accelerator equipment to provide control and acquisition through electrical signals.

Systems designed for advanced physics research typically incorporate large numbers of analog-to-digital (A/D) sensors to perform intensive data collection and processing. Now, one high-performance system can simultaneously measure analog signals and process data with precision. Plus, signal transfers for high-speed serial communication can be implemented without cables via the backplane.

Many leading institutes use modular open standard platforms for their mixed signal applications. For example:

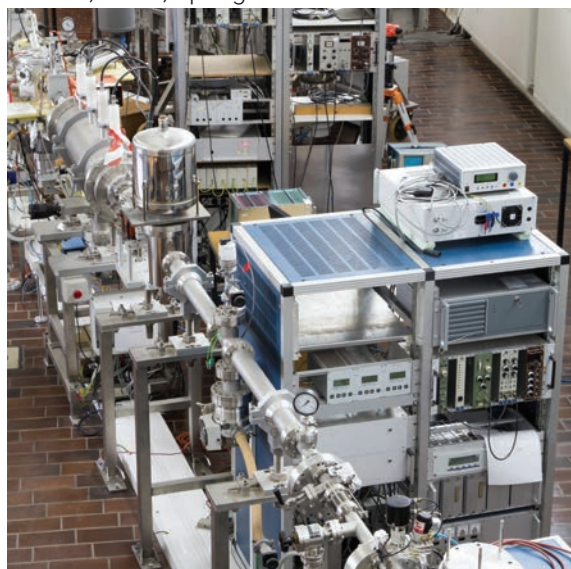

- ESS, DESY, J-PARC, IHEP, GSI use MicroTCA.4
- CERN, SLAC, Spring8 use AdvancedTCA



## **MICROTCA.4 (MTCA)**

Originally developed for the telecommunications industry, the highly scalable MicroTCA standard was modified to meet the critical requirements of physics applications. For this market, the standard provides high bandwidth on the backplane, is structured for availability and reliability, scales well with multiple processors, and supports flexible, high-bandwidth I/O.

The MicroTCA standard is especially suited for decentralized distribution of smaller systems with lower power requirements. It supports 100 GbE and PCIe up to Gen 5.







	<b>11850-021</b>	<b>11890-152</b>
Application	Laboratory	Deployment
AMC Slots	6 Double Mid-size and 1 Double Full-size	12 Double Full-size AMC modules
RTM Slots	6 Double Mid-size and 1 Double Full-size	6 Double Full-size
MCH Slots	1 Double Full-size	2 Single Full-size
PM Slots	1 Double Full-size	4 + 2 Single Full-size
JSM	No	1 Single Full-size JSM slot on the rear side
Backplane Topology	MTCA.4 Star Topology	MTCA.4 Dual Star Topology, JSM
Optionally with RF Backplane	Yes (RF backplane design required)	No
Data Transfer	40 GbE; PCIe Gen3	40 GbE; PCIe Gen3
Type	Half 19" rack mount	19" rack mount
Power per Slot	80 W	80 W
Airflow Direction	Bottom to top	Bottom to top
Rack Height	5 U	7 U
Depth	42 HP, 373 mm	84 HP, 373 mm
		



# MicroTCA Systems for Modular Applications

## KEY BENEFITS

- A choice of form factors – ranging from desktop up to 19"
- A protocol-agnostic backplane allowing for the choice of data transfer protocol (PCIe, Ethernet, or custom for communication between FPGAs), based on high-bandwidth point-to-point links
- Advanced Mezzanine Card (AMC) carriers and a selection of mezzanine boards
- Compatibility with a variety of state-of-the-art digital technologies, including PCIe Gen 5 and 100G Ethernet, and other high-speed interconnects
- Redundancy at the infrastructure level (PSU, cooling, shelf management) for uninterrupted operation and high availability (99.999%)
- Optional Low-Level RF Backplane to be mounted behind the MTCA signal backplane
- Wide range of accessories, including front panels, filler panels and power supply units

11890-170	11850-026	11850-027	11850-030	11890-164	11850-040
Deployment	Deployment	Deployment	Deployment	Deployment	Deployment
12 Double Full-size AMC modules	12 Double Mid-size	12 Double Mid-size	12 Double Mid-size	5 Double Mid-size, 1 Double Full-size	12 Double Mid-size
6 Double Full-size	12 Double Mid-size	12 Double Mid-size	12 Double Mid-size	4 Double Mid-size	12 Double Mid-size
2 Single Full-size	2 Double Full-size	2 Double Full-size	2 Double Full-size	1 Double Full-size	2 Double Full-size
4 + 2 Single Full-size	4 Double Full-size	4 Double Full-size	4 Double Full-size	2 Double Full-size	4 Double Full-size
1 Single Full-size JSM Slot on the rear side	No	1 Single Full-size JSM slot on rear side	1 Single Full-size JSM slot on rear side	Optional with integrated JSM	1 Single Full-size JSM slot on rear side
MTCA.4 Dual Star Topology, JSM	MTCA.4 Dual Star Topology	MTCA.4 Dual Star Topology	Data Aggregation Topology	MTCA.4 Dual Star Topology, 2 slots with x16 connections	MTCA.4 Dual Star Topology
No	Yes	Yes	Yes	Yes (RF backplane design required)	Yes (RF backplane design required)
40 GbE; PCIe Gen3	40 GbE; PCIe Gen3	40 GbE; PCIe Gen3	40 GbE; PCIe Gen3	40 GbE; PCIe Gen3	100 GbE; PCIe Gen5
19" rack mount	19" rack mount	19" rack mount	19" rack mount	19" rack mount	19" rack mount
80 W	80 W	80 W	80 W	80 W	80 W
Front to rear	Front to rear	Front to rear	Front to rear	Front to rear	Front to rear
9 U	9 U	9 U	9 U	3 U	9 U
84 HP, 373 mm	84 HP, 373 mm	84 HP, 373 mm	84 HP, 373 mm	84 HP, 373 mm	84 HP, 373 mm
					

# CompactPCI Serial Systems for High-Speed Data Transfer

## CPCI SERIAL (CPCI-S)

CPCI Serial is the successor of CompactPCI supporting high speed serial data transmission. It's simple architecture with one System Slot and up to 8 peripheral slots allows users to easily adopt this technology. It supports 100 GbE, PCIe Gen 5, USB and S\_ATA

CompactPCI Serial has been successfully implemented into Particle accelerator control systems and real time data acquisition systems.

## KEY BENEFITS

- Systems and components available worldwide in a variety of configurations from desktop to rackmount solutions
- Data transmission up to 256 Gbps from System slot to the 2 adjacent Peripheral slots.
- The System slot acts as root complex and feeds 8 Peripheral slots without additional switches
- Ethernet is routed either in a star configuration from the system slot to each Peripheral slot, alternatively all 9 slots are connected in an Ethernet Full-Mesh configuration
- 4 different Protocols (PCIe, Ethernet, USB and storage interface) can be used in parallel

	24579-634	24579-421	24579-416	24579-451
Application	Laboratory	Deployment	Deployment	Deployment
Number of Slots	9	9	9	9
Power per Slot	30 W	40 W	40 W	40 W
Data transfer Rate	PCIe Gen3	PCIe Gen3	PCIe Gen3	PCIe Gen4
Ethernet Topology	Star	Star	Star	Star
System Slot	left	left	left	left
RTM	No	Yes	No	Yes
Power Supply	1x Pluggable PSU, 300 W	2x Pluggable PSU, 300 W	1x Pluggable PSU, 300 W	2x Pluggable PSU, 300 W
Type	19" rack mount	19" rack mount	19" rack mount	19" rack mount
Airflow Direction	Front to rear	Bottom to top	Bottom to top	Bottom to top
Rack Height	4 U	4 U	4 U	4 U
Depth	275 mm	275 mm	275 mm	275 mm
				

# PXI Express Systems for High-Speed Data Transfer

## PXI EXPRESS (PXIE)

The open industry platform PXI Express (Developed by the PXI Systems Alliance) is an adaptation of the PXI platform which uses the PCI Express bus and CompactPCI Express form factor. Its primary application is a wide range of high-performance, PC-based test and measurement applications in industry, research, and development.

PXI Express, based on PC architecture, is specifically defined for measurement and automation systems with high demands on synchronization and flexibility as well as the scalability of measurement systems. The primary innovations compared to PXI are higher data transfer rates, extended timing & synchronization functions, as well as backwards compatibility.

## KEY BENEFITS

- Provision of a 10 MHz single-ended clock, a differential 100 MHz clock and a differential SYNC signal for each slot.
- Delay-free and interruption-free source changing (external / internal / standalone) of these clock signals in system operation is also important.
- Expansion of the PCI Express bus with additional ports via one or more Express switches allows for larger measurement systems. This is necessary due to the limited link count of the system controller of 4 ports maximum, limiting the number of direct point-to-point PCIe connections.
- Implementation of a PCIe-to-PCI bridge enables operation of PXI cards in the chassis in addition to the PXI Express cards via their parallel 32bit PCI bus.
- Active control of cooling performance minimizes noise emissions, which is important when used in a laboratory.

Model	8 slot PXIe/PCIe Gen 2	8 slot PXIe/PCIe Gen 3	18 slot PXIe/PCIe Gen 2	8 slot PXIe/PCIe Gen 2 & 3	18 slot PXIe/PCIe Gen 3	18 slot PXIe/PCIe Gen 3 (NEW)
Part number	14579-033	14579-030	14579-043	14579-044	14579-040	14579-042
Slot Count	8	8	18	18	18	18
PXI Express System Slot	1	1	1	1	1	1
Hybrid Slots	7	7	16	16	16	16
PCI Gen 2 Peripheral Slots	4 x1	-	17 x4	7 x4	-	-
PCI Gen 3 Peripheral Slots	3 x4	7 x4	-	10 x4	17 x4	17 x8
System Timing Slot	-	-	1	1	1	1
Maximum System Bandwidth	12.5 GB/s	16 GB/s	2 GB/s	9 GB/s	16 GB/s	24 GB/s
Maximum Slot Bandwidth "slot-to-slot"	4 GB/s & 0.5 GB/s	4 GB/s	0.5 GB/s	4 GB/s & 0.5 GB/s	4 GB/s	8 GB/s
System Slot Type	Four link (3 x4 /1 x1)	Four link (4 x4)	Four link (4 x1)	Four link (2 x4 /2 x1)	Four link (4 x4)	Two link (8 +16)
External Trigger Access	Front (On request)	Front (On request)	Front (On request)	Front (On request)	Front (On request)	Front
Power Supply Type	Integrated	Integrated	Integrated	Integrated	Integrated	Rear Pluggable
Slot Cooling Capacity "temperature increase @15 K"	50 W	50 W	50 W	50 W	50 W	80 W





# Subracks, Cases and Accessories

To accommodate FPGAs for data processing in custom modules from the prototyping phase through serial manufacturing, count on our comprehensive portfolio of subracks and enclosures. For rack mounting, benchtop or portable use, they come in air-cooled and conduction-cooled versions.

## SUBRACKS AND CHASSIS FOR RACK-MOUNTING

Our subracks and 19" rackmount enclosures allow a high degree of design flexibility and meet application requirements, such as EMC shielding, shock and vibration resistance, and offer various cooling solutions.

**EuropacPRO** for Eurocard boards mounted vertically

**MultipacPRO** for nonstandard boards mounted horizontally

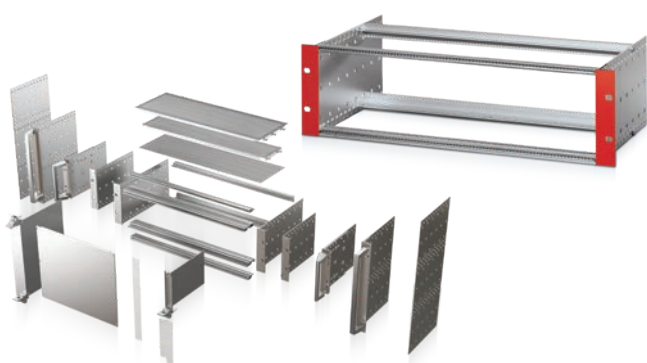

## CASES FOR RACK-MOUNTING AND MOBILE

Take advantage of configurable off-the-shelf solutions for CompactPCI Serial, PXI Express, small form factor technologies or proprietary electronics. All available in portable, desktop or rack-mount designs. Accessories include case handles, feet, rack ears, grounding kits and much more!

**RatiopacPRO**, the flexible 19" case for desktop and/or rack use with advanced cooling capabilities.

**Interscale**, the easy-to-assemble enclosure for small form factor and proprietary electronics, with integrated EMC-shielding.

**High IP Pro**, the rugged aluminum die-cast enclosure to protect electronics from dust, water and shock and vibration.

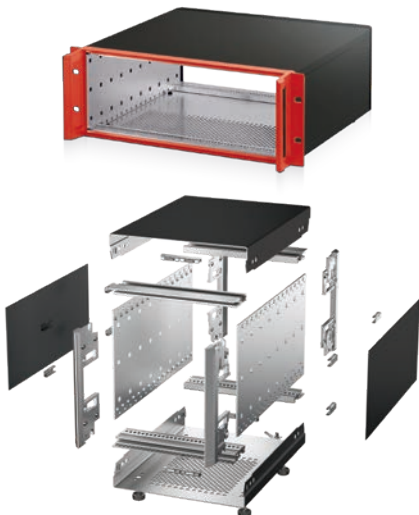

# nVent SCHROFF Capabilities

## DEVELOPMENT AND ENGINEERING

---

- More than 50 years of experience with mechanic, backplane and PSU designs
- Commitment to innovation and advanced technology
- Active membership in specification committees helps evolve new forward-looking standards and helps our customers in the development of new technologies



## DESIGN VERIFICATION TESTING

---

- Optimized layout helps ensure high signal quality and economic production
- Skilled developers and modern design tools help ensure our high-quality standards
- Signal integrity simulation
- Signal integrity measurement (time and frequency domain measurements)
- Measurement adapter (paddle cards) for different connector/backplane types

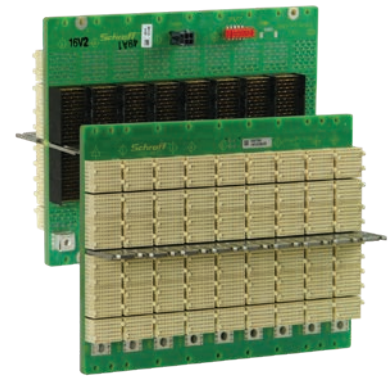

## THERMAL SIMULATION AND TESTING

---

- Thermal simulation allows the development of cooling concepts with the highest level of performance.
- Thermal simulation with simulation software 6Sigma
- Thermal testing at in-house thermal lab
- Air performance measurements, including air flow and acoustic noise



## ENVIRONMENTAL PROTECTION TESTING

---

- Static and dynamic load test in accordance with IEC 61587-1
- Material inspection
- Salt fog for corrosion resistance
- Electromagnetic shielding performance test in accordance with VG 95373
- Indoor and outdoor environment tests in accordance with IEC 61969-3
- Climatic tests consist of a variety of temperature, humidity and industrial tests



## REFERENCE:

# Deutsches Elektronen-Synchrotron DESY, Germany

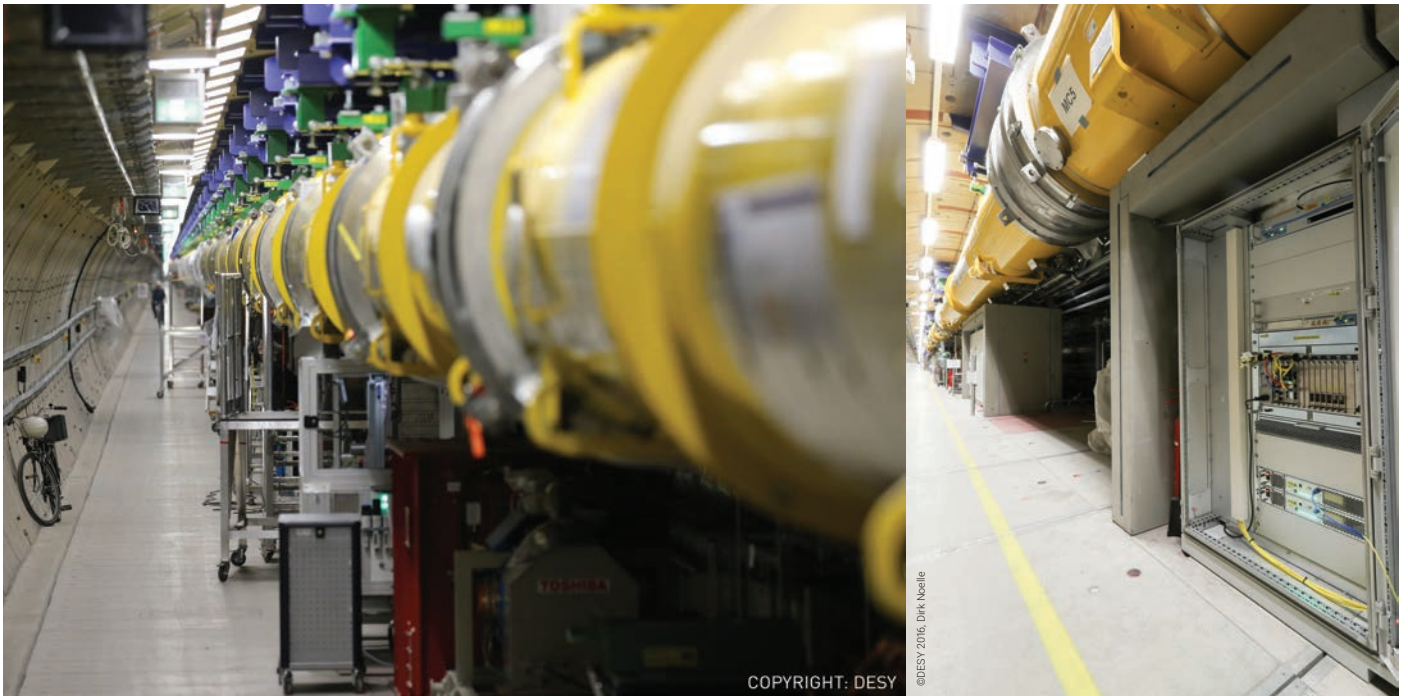

The European XFEL is a 3.4-kilometer-long particle accelerator that generates the world's strongest and brightest X-ray. It requires many types of electronic components with distinct specifications to communicate with one another in real time to synchronize complicated data signals.

### **NVENT DELIVERED**

Collaborating with international organizations, DESY and the nVent SCHROFF engineering team developed the specifications for a new standard – MTCA.4 – to make it possible to use MicroTCA crates to transmit large amounts of graphics data.

With the new standard, nVent:

- Manufactured 250 MTCA.4 crates for DESY and the European XFEL
- Delivered the high-performance, reliable nVent SCHROFF Varistar LHX cabinet and cooling enclosure solutions to house the MicroTCA crates.
- Leveraged these solutions to also protect the sensitive servers against shock and vibration, and provided EMC shielding.



### **RESULTS**

With nVent's help, DESY became the first group in the world to implement the MicroTCA standard in an accelerator, enabling it to perform at full strength.



## REFERENCE:

# European Spallation Source (ESS), Sweden



The ESS set out to build a world-leading multidisciplinary research facility. Once fully operational, the facility will enable scientific breakthroughs in research related to materials, energy, health and the environment.

### **NVENT DELIVERED**

ESS provided the nVent SCHROFF engineering team with specifications for the gallery cabinet solutions, all of which needed to be hosted and efficiently kept cool. Plus, the heat dissipation varied depending on the assembled modules, and some areas required especially tight temperature ranges.

The final solution comprises 20 hot aisle containments, including over 900 19" nVent SCHROFF Varistar racks, around 200 Varistar SHX cooling units and close to 900 of power distribution units (PDUs).



### **RESULTS**

The nVent SCHROFF team completed each of its designated responsibilities – from design through delivery, installation and commissioning – on schedule and within budget.



### **North America**

Tel +1.800.545.6258

Fax +1.800.527.5703

Tel +1.650.216.1526

Fax +1.650.474.7711

info@nVent.com

### **Europe, Middle East, Africa**

Tel +32.16.213.511

Fax +32.16.213.603

info@nVent.com

### **Asia Pacific**

Tel +86.21.2412.1688

Fax +86.21.5426.3167

cn.info@nVent.com

### **Latin America**

Tel +1.713.868.4800

Fax +1.713.868.2333

info@nVent.com



Our powerful portfolio of brands:

**CADDY**

**ERICO**

**HOFFMAN**

**ILSCO**

**RAYCHEM**

**SCHROFF**