

Chillers and Air Conditioners General Catalogue





Table of Content

At the Heart of Technology.....	6	BLU60	68
NXT04	10	BLUA0	69
NXT06	11	BLUA5	70
NXT08	12	BLUB5	71
NXT10	13	MIX22	74
NXT12	14	MIX36	75
NXT16	15	MIX50	76
NXT20	16	MIX80	77
NXT30	17	At the Heart of Technology.....	80
NXT40	18	TCW08÷19 Minichiller	84
NXT60	19	TCW31-41 Minichiller HP	86
Accessories.....	20	C-Next TAL24-37 Size 1	88
Options	23	C-Next TAL29÷A0 Size 1 Three-phase	90
EGOS3	26	C-Next TALA1÷A8 Size 2	92
EGO60	27	C-Next TALB5÷C5 Size 3	94
EGO80	28	C-Next TALD0÷F8 Size 4	96
EGOA0	29	C-Next TALG9÷O6 Size 5	98
EGOA5	30	TCO08÷19 Minichiller	102
Accessories.....	31	TCO31-41 Minichiller HP	104
DEK04	34	C-NEXT TAO24-37 Size 1	106
DEK08	35	C-NEXT TAO29÷A0 Size 1 Three-phase	108
DEK12	36	C-NEXT TAOA1÷A8 Size 2	110
DEK15	37	C-NEXT TAOB5÷C5 Size 3	112
DEK20	38	C-NEXT TAOD0÷F8 Size 4	114
DEK30	39	TCI56÷91 Size 2	118
DEK40	40	TCIA2÷A7 Size 3	120
Accessories.....	41	C-NEXT TAU24-37 Size 1	124
NOX06	44	C-NEXT TAU29÷A0 Size 1 Three-phase	126
NOX08	45	SAW50	130
NOX10	46	SAWA0	132
NOX12	47	Chiller Fluid	134
NOX16	48	Notes	136
NOX20	49		
NOX30	50		
NOX40	51		
NOX60	52		
EMO60	56		
EMO80	57		
EMOA0	58		
Accessories.....	59		
BIT25	62		
BLU10	63		
BLU18	64		
BLU25	65		
BLU35	66		
BLU45	67		



Air Conditioning Range

A comprehensive range of industrial air conditioners for indoor or outdoor application.



At the Heart of Technology

There are numerous reasons to choose a nVent cooling system

By listening to our Customers and harnessing our long experience in the industrial sector, we have built a comprehensive offering of high-quality cutting-edge products in the area of industry 4.0 systems applied to climate control.

Our strong product engineering has allowed us to standardise and include many previously optional extras as standard equipment throughout the range.

The new E-NEXT range has achieved the top certifications in our industry, including the UL LISTED seal for the U.S. and Canada.

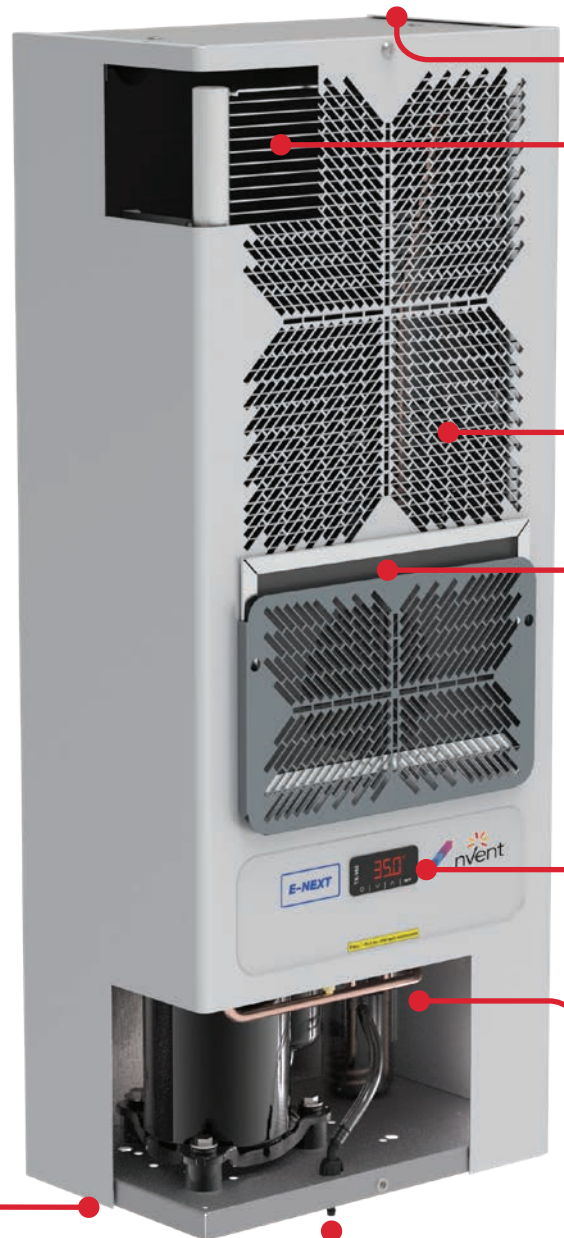

CONDENSATE DISCHARGE

Safety first! All air conditioners are equipped with an external condensate drain, ensuring the safety of the systems in any and all situations.

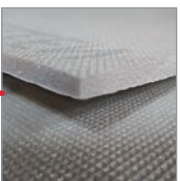

DIE-CUT SEALS

To achieve a perfect seal between the electrical panel and the air conditioner, nVent provides an integrated seal that ensures simple installation and perfect adhesion between the surfaces.



EXTERNAL OR SEMI-RECESSED INSTALLATION

The entire E-NEXT range can be ordered for external installation (standard) or for external and semi-recessed installation, giving you maximum flexibility.



LOWER MAINTENANCE COSTS

Using latest-generation microchannel technology air conditioners brings with it fast and effective maintenance over the years, not to mention 30% savings on refrigerant.



OUTDOOR APPLICATIONS

A range of specific air conditioning units for outdoor applications, the cataphoresis treatment of the condensing coil and the IP54-rated protection of all electrical components make this product reliable in all atmospheric conditions.

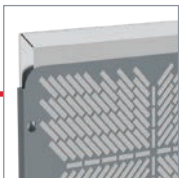

EASY TO INSTALL FILTER

The new magnetic filter support fastening system makes maintenance super simple and preserves the attractive design of the E-NEXT range.



THERMOSTAT WITH DIGITAL DISPLAY

The new TX-i40 thermostat provides complete and flexible management of the air conditioner, ensuring easy management and connectivity via MODBUS protocol.



PASSIVE CONDENSATE DISSIPATOR

Standard on all vertical air conditioning units from 1000 W, this dissipation system saves energy as it draws no power, eliminating condensate without the need to channel it externally.

E-NEXT

Door- or wall-mount air conditioners



GAS

Air conditioners all come pre-charged with R134a refrigerant



Integrated Modbus

All air conditioners with TX-i40 can be provided with MODBUS RTU RS485 connection on request.



Advanced sequencing

All units are equipped with connection to sequence the operation of two air conditioners. This option allows back-up operation and distribution of operating hours.



Advanced microport

Customers can easily program whether or not to lock the internal fan when the microport opens.



ECO mode

Standard feature on the entire range to optimise electricity use under low working load conditions.



°C / °F

Change only one parameter to go from Celsius to Fahrenheit.



Predictive maintenance

An advanced system enables the air conditioner to self-learn and alert the user when maintenance is due.



Service mode

Runs a simple check procedure to ensure the air conditioner is working properly; useful during installation.



Humidity control

This option (supplied on request) uses a humidistat to control the humidity inside the cabinet; ideal for applications in tropical areas.



EC Fans

Available on request, electronic fans increase air conditioner efficiency by further reducing energy consumption and related operating costs.



Low-noise version

Available on request, the version with reduced modulated speed fans enables low-noise operation in outdoor residential or commercial applications.



NXT04

Door- or wall-mount air conditioners

COOLING CAPACITY

380 W

DIMENSIONS

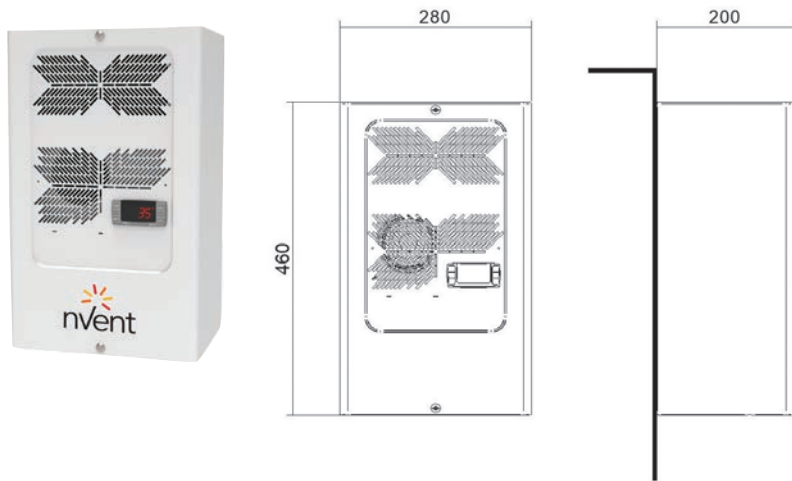

PERFORMANCE

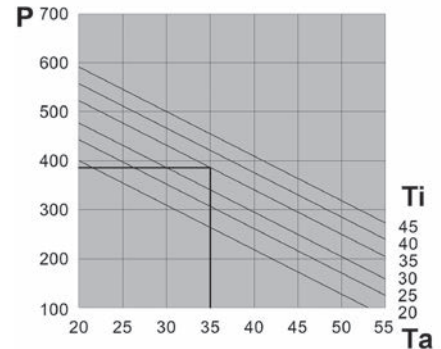

- P = Cooling capacity (W)
- Ta = Ambient Temperature (°C)
- Ti = Internal cabinet temperature (°C)

Features	UoM	NXT04K0T1C00000	NXT04B0T1U00000	NXT04C0T1U00000
Cooling capacity EN14511 - A35A35	W	380	380	380
Cooling capacity EN14511 - A35A50	W	240	240	240
Power supply	V ~ Hz	400/460 - 2 - 50/60	230 - 1 - 50/60	115 - 1 - 60
Width - Height - Depth	mm	280 - 460 - 200+55*	280 - 460 - 200	280 - 460 - 200
Max current	A	0.9	1.5	3.4
Inrush current	A	5	8.6	22.6
T Fuse	A	2	4	6
Power draw EN14511 - A35A35	W	240	240	240
Power draw EN14511 - A35A50	W	277	277	277
Electrical connection	-	4-pin plug	4-pin plug	4-pin plug
Cabinet air fan capacity	m ³ /h	165	165	165
Internal temperature range	°C	20-45	20-45	20-45
Temperature regulation	-	Electronic thermostat TX050 factory set to 35°C		
External temperature range	°C	20-55	20-55	20-55
Ingress protection - cabinet side	-	IP55	NEMA TYPE 12	NEMA TYPE 12
Noise level	dB (A)	60	60	60
Weight	kg	20	17	17
Conformity	-	CE UK	UL CE UK	UL CE UK

* for autotransformer external dimensions semi-recessed installation version page 35

NXT06

Door- or wall-mount air conditioners

COOLING CAPACITY

720 W

DIMENSIONS

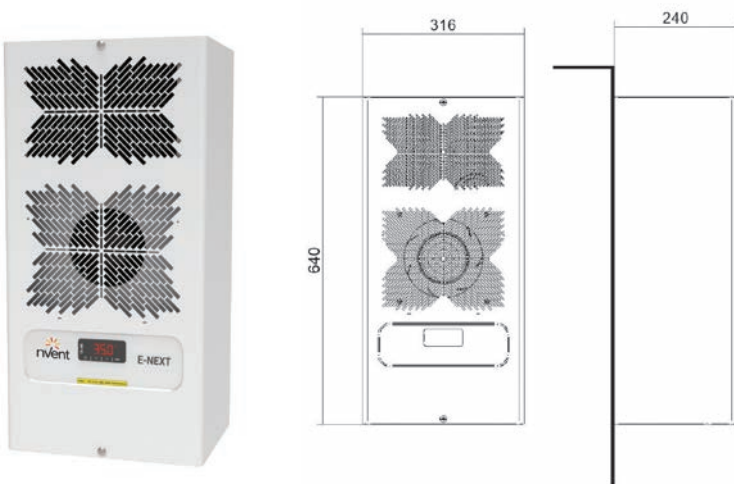

PERFORMANCE

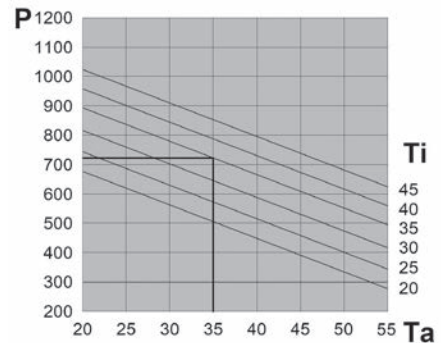

Features	UoM	NXT06K0E1C00000	NXT06B0E1U00000	NXT06C0E1U00000
Cooling capacity EN14511 - A35A35	W	720	720	720
Cooling capacity EN14511 - A35A50	W	555	555	555
Power supply	V ~ Hz	400/460 - 2 - 50/60	230 - 1 - 50/60	115 - 1 - 60
Width - Height - Depth	mm	316 - 640 - 240	316 - 640 - 240	316 - 640 - 240
Max current	A	1.3	2.3	4.3
Inrush current	A	6.3	10.9	22.2
T Fuse	A	4	6	8
Power draw EN14511 - A35A35	W	380	380	420
Power draw EN14511 - A35A50	W	450	450	500
Electrical connection	-	4-pin plug	4-pin plug	4-pin plug
Cabinet air fan capacity	m ³ /h	305	305	305
Internal temperature range	°C	20-45	20-45	20-45
Temperature regulation	-	Electronic thermostat TX-i40 factory set to 35°C		
External temperature range	°C	20-55	20-55	20-55
Ingress protection - cabinet side	-	IP55	NEMA TYPE 12	NEMA TYPE 12
Noise level	dB (A)	65	65	65
Weight	kg	26	24	24
Conformity	-	CE UK CA	UL CE UK CA	UL CE UK CA

Version for semi-recessed installation page 35

NXT08

Door- or wall-mount air conditioners

COOLING CAPACITY

880 W

DIMENSIONS

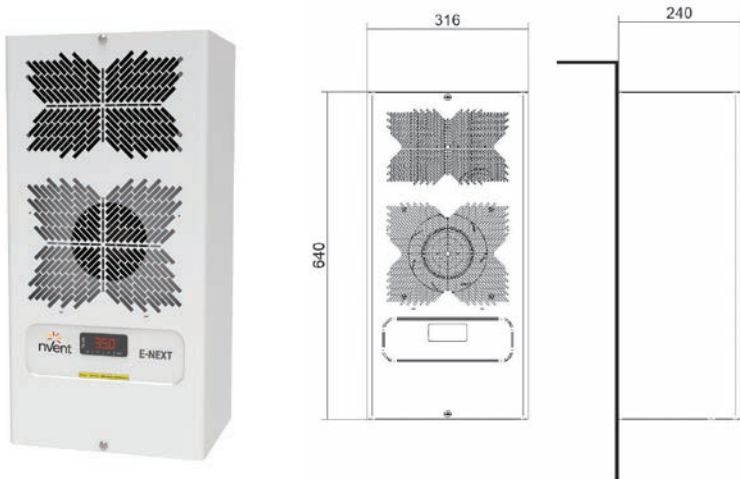

PERFORMANCE

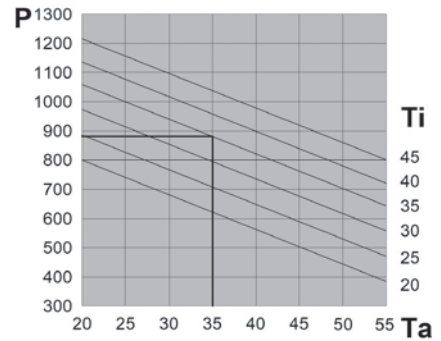

- P = Cooling capacity (W)
- Ta = Ambient Temperature (°C)
- Ti = Internal cabinet temperature (°C)

Features	UoM	NXT08K0E1C00000	NXT08B0E1U00000	NXT08C0E1U00000
Cooling capacity EN14511 - A35A35	W	880	880	880
Cooling capacity EN14511 - A35A50	W	705	705	705
Power supply	V ~ Hz	400/460 - 2 - 50/60	230 - 1 - 50/60	115 - 1 - 60
Width - Height - Depth	mm	316 - 640 - 240	316 - 640 - 240	316 - 640 - 240
Max current	A	1.4	2.4	4.2
Inrush current	A	7.4	12.9	22.2
T Fuse	A	4	6	8
Power draw EN14511 - A35A35	W	450	450	430
Power draw EN14511 - A35A50	W	520	520	540
Electrical connection	-	4-pin plug	4-pin plug	4-pin plug
Cabinet air fan capacity	m ³ /h	325	325	325
Internal temperature range	°C	20-45	20-45	20-45
Temperature regulation	-	Electronic thermostat TX-i40 factory set to 35°C		
External temperature range	°C	20-55	20-55	20-55
Ingress protection - cabinet side	-	IP55	NEMA TYPE 12	NEMA TYPE 12
Noise level	dB (A)	65	65	65
Weight	kg	27	25	25
Conformity	-	CE UK	UL CE UK	UL CE UK

Version for semi-recessed installation page 35

NXT10

Door- or wall-mount air conditioners

COOLING CAPACITY

1000 W

DIMENSIONS

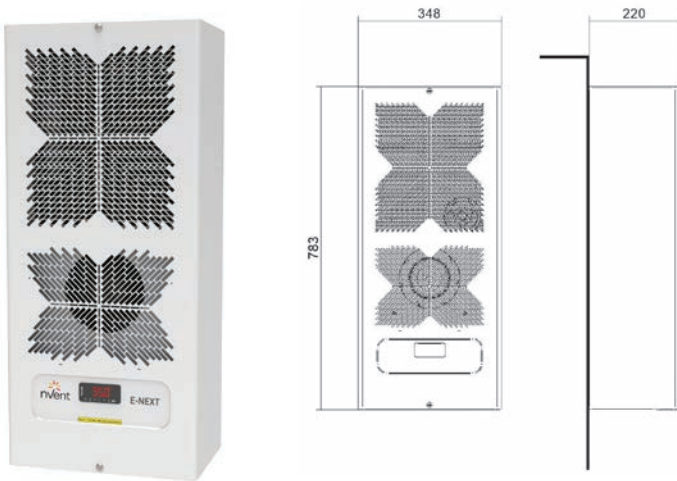

PERFORMANCE

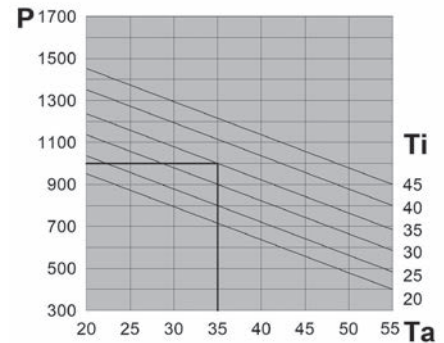

- P = Cooling capacity (W)
- Ta = Ambient Temperature (°C)
- Ti = Internal cabinet temperature (°C)

Features	UoM	NXT10B0E1U00000	NXT10C0E1U00000	NXT10K0E1U00000
Cooling capacity EN14511 - A35A35	W	1000	1000	1000
Cooling capacity EN14511 - A35A50	W	760	760	760
Power supply	V ~ Hz	230 - 1 - 50/60	115 - 1 - 60	400/460 - 2 - 50/60
Width - Height - Depth	mm	348 - 783 - 220	348 - 783 - 220	348 - 783 - 220
Max current	A	3	5.7	1.7
Inrush current	A	13.1	28	7.5
T Fuse	A	6	10	4
Power draw EN14511 - A35A35	W	500	570	500
Power draw EN14511 - A35A50	W	600	670	600
Electrical connection	-	4-pin plug	4-pin plug	4-pin plug
Cabinet air fan capacity	m ³ /h	540	540	540
Internal temperature range	°C	20-45	20-45	20-45
Temperature regulation	-	Electronic thermostat TX-i40 factory set to 35°C		
External temperature range	°C	20-55	20-55	20-55
Ingress protection - cabinet side	-	NEMA TYPE 12	NEMA TYPE 12	NEMA TYPE 12
Noise level	dB (A)	65	65	65
Weight	kg	27	27	29
Conformity	-			

Version for semi-recessed installation page 35

NXT12

Door- or wall-mount air conditioners

COOLING CAPACITY

1250 W

DIMENSIONS

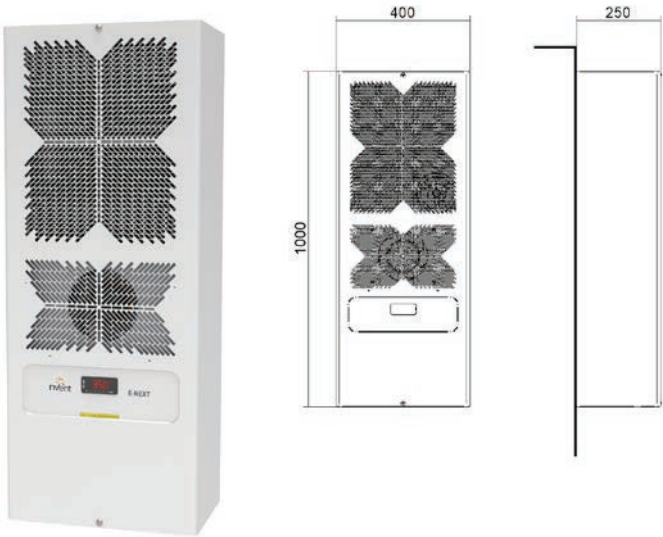

PERFORMANCE

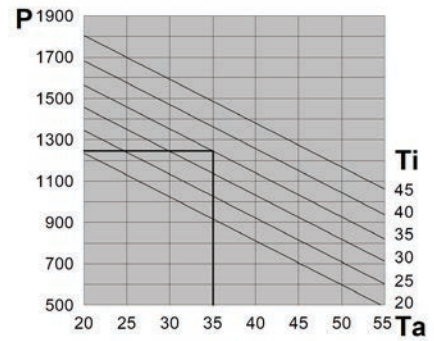

- P = Cooling capacity (W)
- Ta = Ambient Temperature (°C)
- Ti = Internal cabinet temperature (°C)

Features	UoM	NXT12K0E1C00000	NXT12B0E1U00000	NXT12C0E1U00000
Cooling capacity EN14511 - A35A35	W	1250	1250	1250
Cooling capacity EN14511 - A35A50	W	930	930	930
Power supply	V ~ Hz	400/460 - 2 - 50/60	230 - 1 - 50/60	115 - 1 - 60
Width - Height - Depth	mm	400 - 1000 - 250	400 - 1000 - 250	400 - 1000 - 250
Max current	A	1.8	3.2	6.1
Inrush current	A	9.8	17.1	28
T Fuse	A	4	6	10
Power draw EN14511 - A35A35	W	590	590	620
Power draw EN14511 - A35A50	W	680	680	760
Electrical connection	-	4-pin plug	4-pin plug	4-pin plug
Cabinet air fan capacity	m ³ /h	540	540	540
Internal temperature range	°C	20-45	20-45	20-45
Temperature regulation	-	Electronic thermostat TX-i40 factory set to 35°C		
External temperature range	°C	20-55	20-55	20-55
Ingress protection - cabinet side	-	IP55	NEMA TYPE 12	NEMA TYPE 12
Noise level	dB (A)	65	65	65
Weight	kg	41	39	39
Conformity	-	CE UK CA	UL CE UK CA	UL CE UK CA

Version for semi-recessed installation page 35

NXT16

Door- or wall-mount air conditioners

COOLING CAPACITY

1600 W

DIMENSIONS

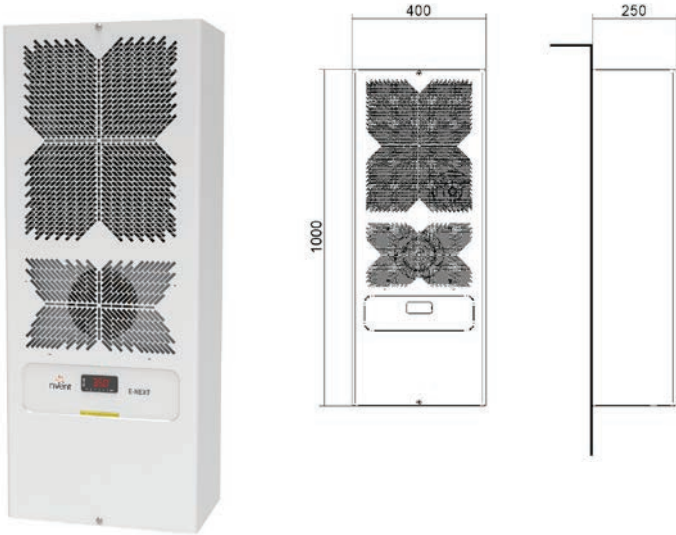

PERFORMANCE

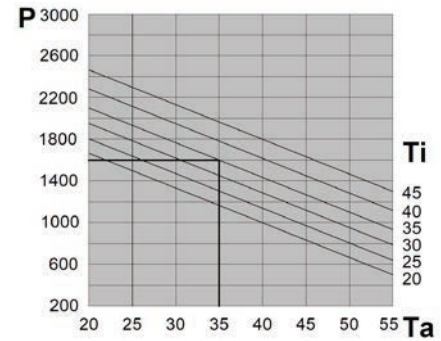

- P = Cooling capacity (W)
- Ta = Ambient Temperature (°C)
- Ti = Internal cabinet temperature (°C)

Features	UoM	NXT16B0E1U00000	NXT16C0E1U00000	NXT16K0E1U00000
Cooling capacity EN14511 - A35A35	W	1600	1600	1600
Cooling capacity EN14511 - A35A50	W	1100	1100	1100
Power supply	V ~ Hz	230 - 1 - 50/60	115 - 1 - 60	400/460 - 2 - 50/60
Width - Height - Depth	mm	400 - 1000 - 250	400 - 1000 - 250	400 - 1000 - 250
Max current	A	4.3	8.2	2.4
Inrush current	A	19.7	42	10.2
T Fuse	A	8	16	6
Power draw EN14511 - A35A35	W	720	830	720
Power draw EN14511 - A35A50	W	820	960	820
Electrical connection	-	4-pin plug	4-pin plug	4-pin plug
Cabinet air fan capacity	m ³ /h	540	540	540
Internal temperature range	°C	20-45	20-45	20-45
Temperature regulation	-	Electronic thermostat TX-i40 factory set to 35°C		
External temperature range	°C	20-55	20-55	20-55
Ingress protection - cabinet side	-	NEMA TYPE 12	NEMA TYPE 12	NEMA TYPE 12
Noise level	dB (A)	65	65	65
Weight	kg	41	41	43
Conformity	-			

Version for semi-recessed installation page 35

NXT20

Door- or wall-mount air conditioners

COOLING CAPACITY

2000 W

DIMENSIONS

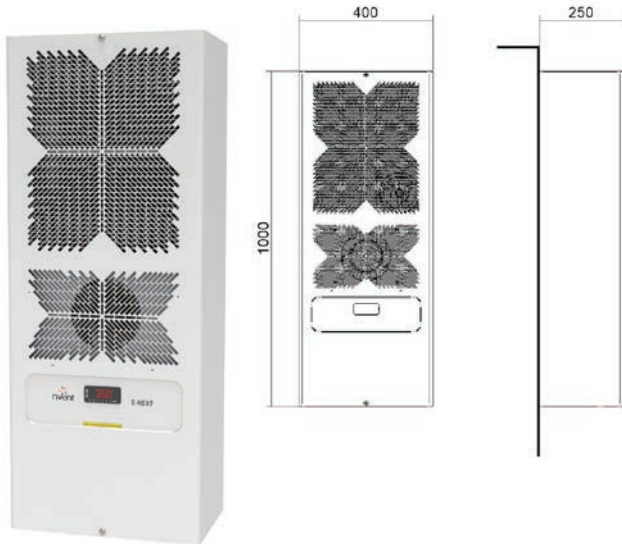

PERFORMANCE

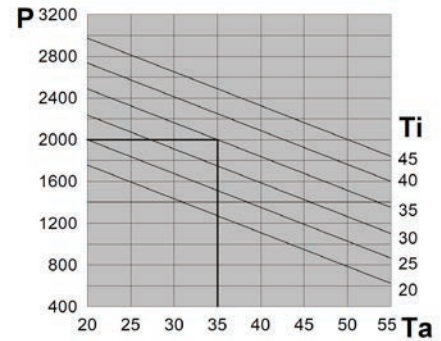

- P = Cooling capacity (W)
- Ta = Ambient Temperature (°C)
- Ti = Internal cabinet temperature (°C)

Features	UoM	NXT20B0E1U00000	NXT20C0E1U00000	NXT20H0E1U00000
Cooling capacity EN14511 - A35A35	W	2000	2000	2000
Cooling capacity EN14511 - A35A50	W	1500	1500	1500
Power supply	V ~ Hz	230 - 1 - 50/60	115 - 1 - 60	400/3/50 460/3/60
Width - Height - Depth	mm	400 - 1000 - 250	400 - 1000 - 250	400 - 1000 - 250
Max current	A	4.8	11.3	1.6
Inrush current	A	21.8	56.8	12
T Fuse	A	10	16	4
Power draw EN14511 - A35A35	W	990	1170	870
Power draw EN14511 - A35A50	W	1130	1360	1050
Electrical connection	-	4-pin plug	4-pin plug	4-pin plug
Cabinet air fan capacity	m³/h	540	540	540
Internal temperature range	°C	20-45	20-45	20-45
Temperature regulation	-	Electronic thermostat TX-i40 factory set to 35°C		
External temperature range	°C	20-55	20-55	20-55
Ingress protection - cabinet side	-	NEMA TYPE 12	NEMA TYPE 12	NEMA TYPE 12
Noise level	dB (A)	77	77	77
Weight	kg	42	42	44
Conformity	-	UL LISTED CE UK CA	UL LISTED CE UK CA	UL LISTED CE UK CA

Version for semi-recessed installation page 35

NXT30

Door- or wall-mount air conditioners

COOLING CAPACITY

3000 W

DIMENSIONS

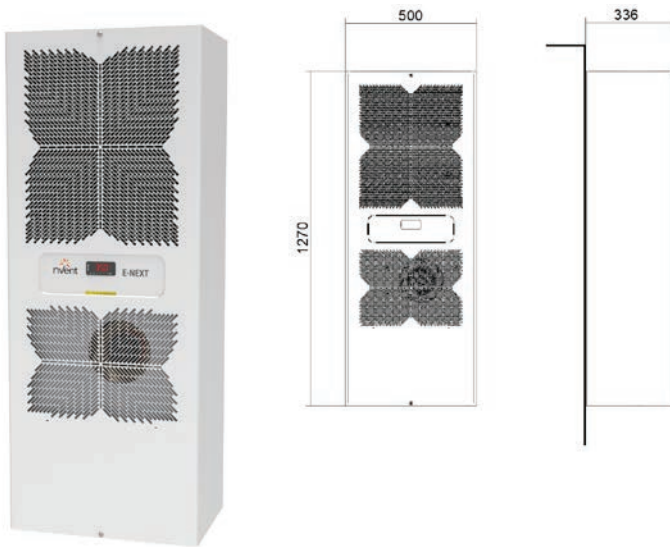

PERFORMANCE

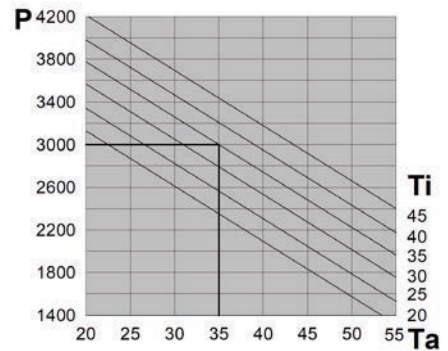

- P = Cooling capacity (W)
- Ta = Ambient Temperature (°C)
- Ti = Internal cabinet temperature (°C)

Features	UoM	NXT30B0E1U00000	NXT30H0E1U00000
Cooling capacity EN14511 - A35A35	W	3000	3000
Cooling capacity EN14511 - A35A50	W	2210	2210
Power supply	V ~ Hz	230 - 1 - 50/60	400/3/50 - 460/3/60
Width - Height - Depth	mm	500 - 1270 - 336	500 - 1270 - 336
Max current	A	5.2	2.4
Inrush current	A	35	20
T Fuse	A	10	6
Power draw EN14511 - A35A35	W	1190	1140
Power draw EN14511 - A35A50	W	1380	1350
Electrical connection	-	4-pin plug	4-pin plug
Cabinet air fan capacity	m ³ /h	1500	1500
Internal temperature range	°C	20-45	20-45
Temperature regulation	-	Electronic thermostat TX-i40 factory set to 35°C	
External temperature range	°C	20-55	20-55
Ingress protection - cabinet side	-	NEMA TYPE 12	NEMA TYPE 12
Noise level	dB (A)	70	70
Weight	kg	66	70
Conformity	-		

NXT40

Door- or wall-mount air conditioners

COOLING CAPACITY

3850 W

DIMENSIONS

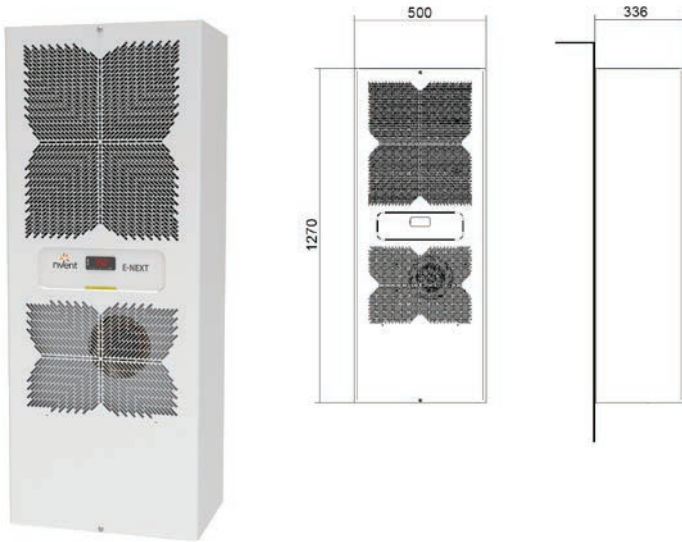

PERFORMANCE

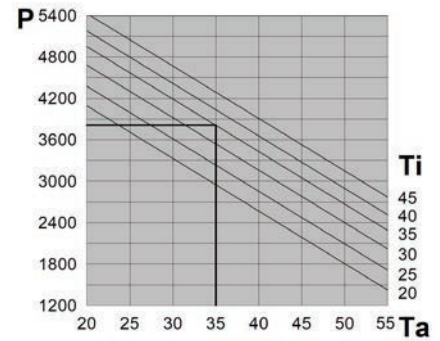

- P = Cooling capacity (W)
- Ta = Ambient Temperature (°C)
- Ti = Internal cabinet temperature (°C)

Features	UoM	NXT40B0E1U00000	NXT40H0E1U00000
Cooling capacity EN14511 - A35A35	W	3850	3850
Cooling capacity EN14511 - A35A50	W	2650	2650
Power supply	V ~ Hz	230 - 1 - 50/60	400/3/50 - 460/3/60
Width - Height - Depth	mm	500 - 1270 - 336	500 - 1270 - 336
Max current	A	7.8	3.6
Inrush current	A	37	18
T Fuse	A	16	8
Power draw EN14511 - A35A35	W	1670	1780
Power draw EN14511 - A35A50	W	1980	2050
Electrical connection	-	4-pin plug	4-pin plug
Cabinet air fan capacity	m ³ /h	1500	1500
Internal temperature range	°C	20-45	20-45
Temperature regulation	-	Electronic thermostat TX-i40 factory set to 35°C	
External temperature range	°C	20-55	20-55
Ingress protection - cabinet side	-	NEMA TYPE 12	NEMA TYPE 12
Noise level	dB (A)	70	70
Weight	kg	70	74
Conformity	-	UL US CE UK CA	UL US CE UK CA

NXT60

Door- or wall-mount air conditioners

COOLING CAPACITY

5400 W

DIMENSIONS

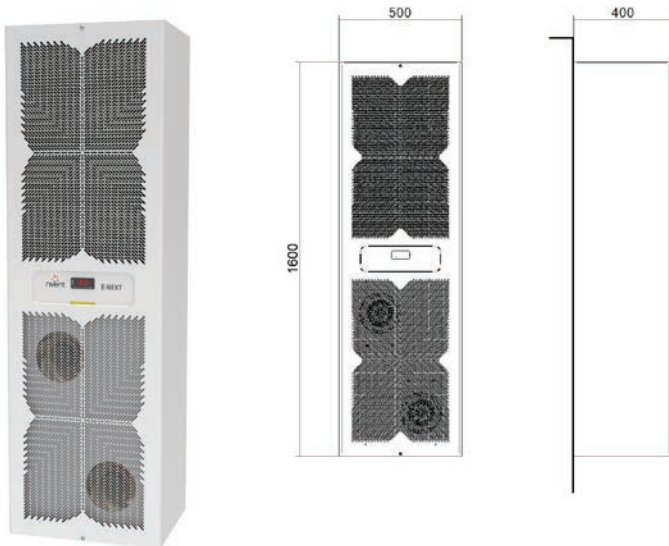

PERFORMANCE

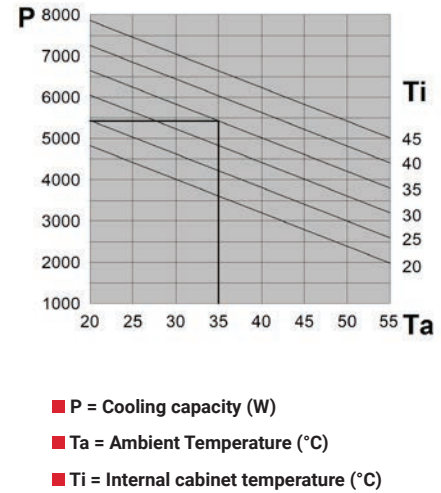

Features	UoM	NXT60H0E1U00000
Cooling capacity EN14511 - A35A35	W	5400
Cooling capacity EN14511 - A35A50	W	4200
Power supply	V ~ Hz	400/3/50 - 460/3/60
Width - Height - Depth	mm	500 - 1600 - 400
Max current	A	3.7
Inrush current	A	32
T Fuse	A	8
Power draw EN14511 - A35A35	W	1950
Power draw EN14511 - A35A50	W	2470
Electrical connection	-	4-pin plug
Cabinet air fan capacity	m ³ /h	1500
Internal temperature range	°C	20-45
Temperature regulation	-	Electronic thermostat TX-i40 factory set to 35°C
External temperature range	°C	20-55
Ingress protection - cabinet side	-	NEMA TYPE 12
Noise level	dB (A)	72
Weight	kg	104
Conformity	-	

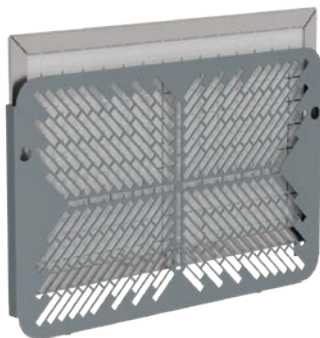

Models	Item code
NXT04	C15W00139
NXT06/08	C15W00140
NXT10	C15W00141
NXT12/16/20	C15W00142
NXT30/40	C15W00143
NXT60	C15W00144

As a separately sold accessory, the E-next range includes magnetic filter support in RAL 7011 and related filter. This accessory comes in handy in demanding applications where frequent servicing is required. The NEN polypropylene filter on aluminium frame allows for fast cleaning and the washable filter can be used repeatedly.

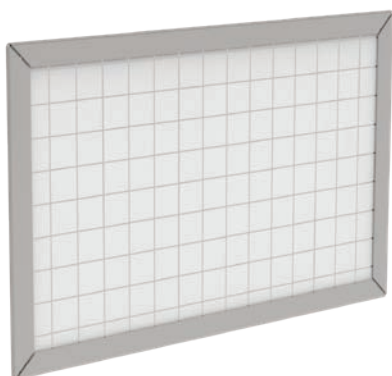

Models	Item code
NXT04	C15007976
NXT06/08	C15007968
NXT10	C15007972
NXT12/16/20	C15007973
NXT30/40	C15007974
NXT60	C15007975

* NXT04 polyurethane air filter

NEN-type replacement filter with aluminium frame for E-NEXT range of air conditioners; filter-holding frame not included.

Accessories



Models	Item code
All models	C12007176

The condensate collection bottle developed by nVent makes it possible to collect the excess condensate from the air conditioner. This accessory is required where no drain is available in the vicinity and you prefer not having water sitting at the base of the panel. The bottle is made of plastic and is supplied with anodised aluminium mount.



Models	Item code
All models except NXT04	C16W00024

The 5-metre-long sequence cable lets you interface two E-NEXT air conditioners installed in the same cabinet; the two units will communicate with each other thanks to the TX-i40 controller, allowing perfect thermal management of the electric cabinet.



Accessories

Air Conditioning Range

Refrigeration Range



Models	Item code
NXT04	C12X00454
NXT06/08	C12X00455
NXT10	C12X00456
NXT12/16/20	C12X00457
NXT30/40/60	C12X00458

Diverter installed at the air outlet in the cabinet are an effective way to avoid cold air short circuits in the cabinet. These are required when installed components in the electrical cabinet prevent good air circulation.



Models	Item code	Recessed
NXT30/40	C12X00439	170 mm
NXT60	C12X00440	150 mm

Semi-recessed frames available for NXT30/40/60 are ideal to reduce the external footprint of the air conditioner by partially recessing it into the cabinet. They are also useful for door installation, to avoid putting excessive strain on cabinet hinges.

Options

E-NEXT range, version for semi-recessed installation

NXT04

Dimensions

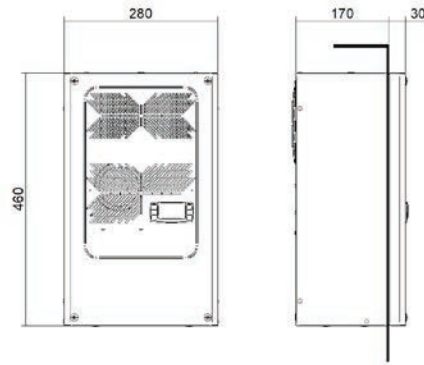

NXT06-08

Dimensions

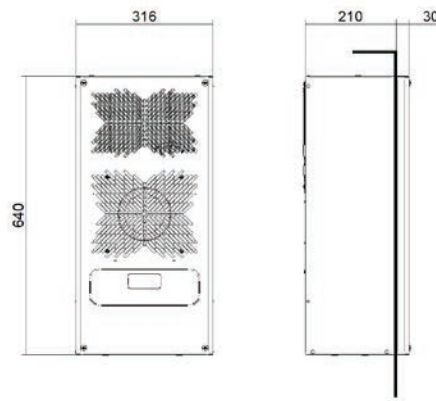

NXT10

Dimensions

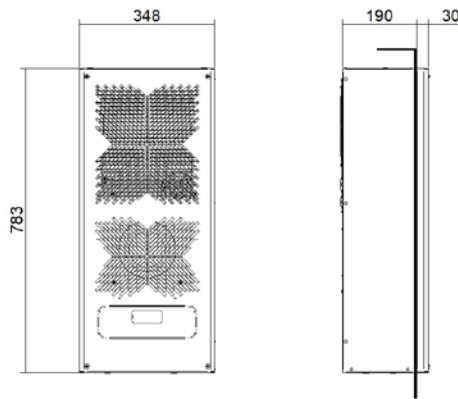

NXT12-16-20

Dimensions

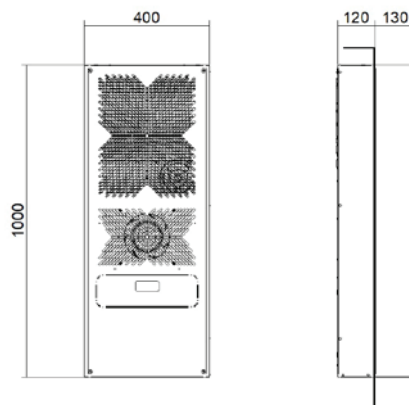



EGO

Door- or wall-mount air conditioners

Electronic Regulation

All nVent air conditioning systems are equipped with electronic regulation as standard.

Quick Installation

Installation is made quick by the simplicity of the drilling to be performed on the cabinet panel, and by the fastening systems.

Reduced Maintenance

All units are designed to prevent clogging by solid contaminants present in the ambient air. The condensing coils are protected by a hydrophilic treatment which prevents dirt and corrosion.



EGOS3

Door- or wall-mount air conditioners

COOLING CAPACITY

300 W



Features	UoM	EGOS3BT1B
Cooling capacity EN14511 - A35A35	W	300
Cooling capacity EN14511 - A35A50	W	150
Power supply	V ~ Hz	230 1~ 50-60
Width - Height - Depth	mm	525 - 345 - 136
Max current	A	1.5
Inrush current	A	4.2
T Fuse	A	4
Power draw EN14511 - A35A35	W	270
Power draw EN14511 - A35A50	W	310
Electrical connection	-	4-pin plug
R134a Refrigerant	kg	0.12
Cabinet air fan capacity	m ³ /h	280
Internal temperature range	°C	20-45
Temperature regulation	-	Electronic thermostat TX050, factory set to 35°C
External temperature range	°C	20-55*
EN60529 ingress protection - cabinet side	-	IP55
Noise level	dB (A)	61
Weight	kg	14
Conformity	-	CE

* 50°C at 60 Hz

PERFORMANCE

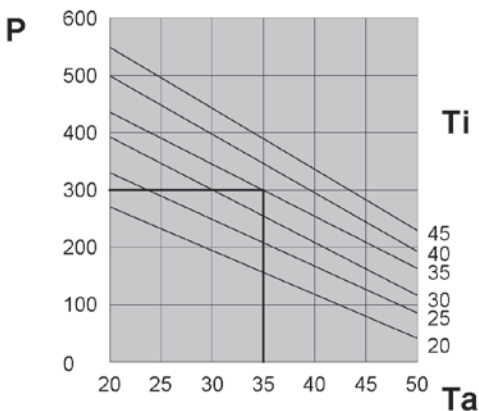

DIMENSIONS

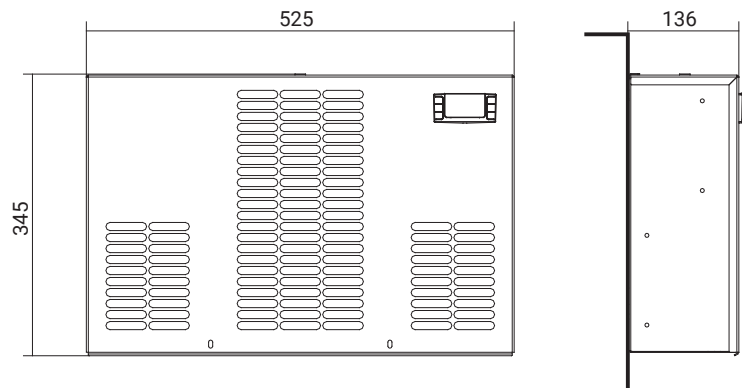

- P = Cooling capacity (W)
- Ta = Ambient Temperature (°C)
- Ti = Internal cabinet temperature (°C)

EGO60

Door- or wall-mount air conditioners

COOLING CAPACITY

5800 - 6050 W



Features	UoM	EGO60MTEB	EGO60NTEB
Cooling capacity EN14511 - A35A35	W	5800	6050
Cooling capacity EN14511 - A35A50	W	4350	4530
Power supply	V ~ Hz	400 3~ 50	460 3~ 60
Width - Height - Depth	mm	600 - 2000 - 387	600 - 2000 - 387
Max current	A	5.9	6.8
Inrush current	A	21.7	23.5
T Fuse	A	8	8
Power draw EN14511 - A35A35	W	2340	2920
Power draw EN14511 - A35A50	W	3880	4520
Electrical connection	-	Cable L = 3 m	Cable L = 3 m
R407C Refrigerant	kg	1.8	1.8
Cabinet air fan capacity	m³/h	1450	1450
Internal temperature range	°C	20-45	20-45
Temperature regulation	-	Electronic thermostat TX050, factory set to 35°C	
External temperature range	°C	20-50	20-50
EN60529 ingress protection - cabinet side	-	IP54	IP54
Noise level	dB (A)	72	72
Weight	kg	150	150
Conformity	-	CE	CE

PERFORMANCE (EGO60MTEB)

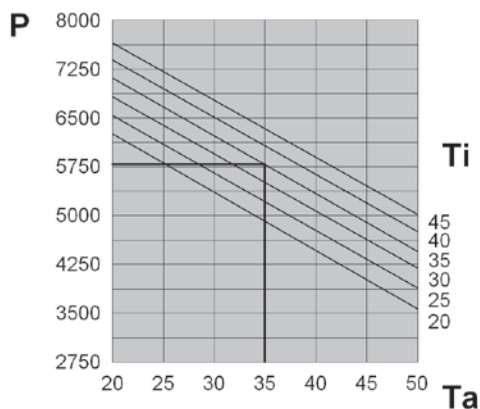

- P = Cooling capacity (W)
- Ta = Ambient Temperature (°C)
- Ti = Internal cabinet temperature (°C)

DIMENSIONS

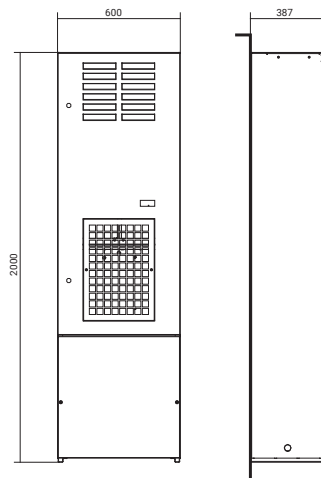

EGO80

Door- or wall-mount air conditioners

COOLING CAPACITY

7600 - 7950 W



Features	UoM	EGO80MTEB	EGO80NTEB
Cooling capacity EN14511 - A35A35	W	7600	7950
Cooling capacity EN14511 - A35A50	W	5700	5930
Power supply	V ~ Hz	400 3~ 50	460 3~ 60
Width - Height - Depth	mm	800 - 2000 - 387	800 - 2000 - 387
Max current	A	8.1	9.3
Inrush current	A	30.7	32.5
T Fuse	A	16	16
Power draw EN14511 - A35A35	W	3300	4035
Power draw EN14511 - A35A50	W	4910	5845
Electrical connection	-	Cable L = 3 m	Cable L = 3 m
R134a Refrigerant	kg	2.8	2.8
Cabinet air fan capacity	m ³ /h	2900	2900
Internal temperature range	°C	20-45	20-45
Temperature regulation	-	Electronic thermostat TX050, factory set to 35°C	
External temperature range	°C	20-50	20-50
EN60529 ingress protection - cabinet side	-	IP54	IP54
Noise level	dB (A)	75	75
Weight	kg	160	160
Conformity	-	CE	CE

PERFORMANCE (EGO80MTEB)

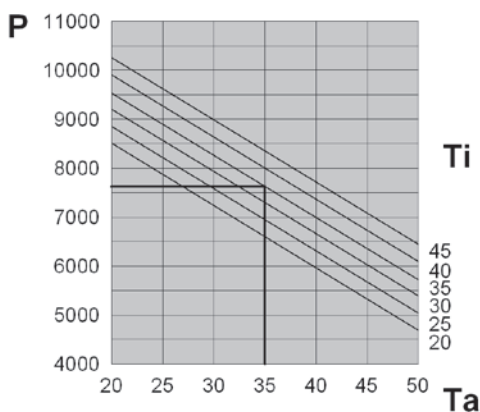

- P = Cooling capacity (W)
- Ta = Ambient Temperature (°C)
- Ti = Internal cabinet temperature (°C)

DIMENSIONS

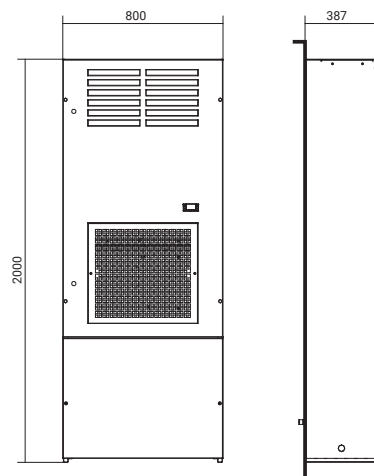

EGOA0

Door- or wall-mount air conditioners

COOLING CAPACITY

9400 - 9850 W



Features	UoM	EGOA0MTEB	EGOA0NTEB
Cooling capacity EN14511 - A35A35	W	9400	9850
Cooling capacity EN14511 - A35A50	W	7000	7350
Power supply	V ~ Hz	400 3~ 50	460 3~ 60
Width - Height - Depth	mm	800 - 2000 - 387	800 - 2000 - 387
Max current	A	9.1	10.3
Inrush current	A	30.7	32.5
T Fuse	A	18	18
Power draw EN14511 - A35A35	W	3650	4380
Power draw EN14511 - A35A50	W	5400	6340
Electrical connection	-	Cable L = 3 m	Cable L = 3 m
R134a Refrigerant	kg	2.3	2.3
Cabinet air fan capacity	m ³ /h	2900	2900
Internal temperature range	°C	20-45	20-45
Temperature regulation	-	Electronic thermostat, factory wset to 35°C	
External temperature range	°C	20-50	20-50
EN60529 ingress protection - cabinet side	-	IP54	IP54
Noise level	dB (A)	77	77
Weight	kg	180	180
Conformity	-	CE	CE

PERFORMANCE (EGOA0MTEB)

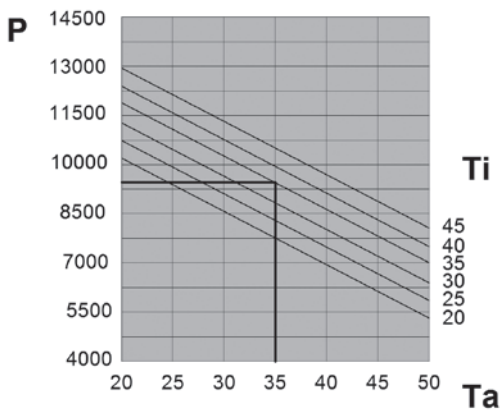

- P = Cooling capacity (W)
- Ta = Ambient Temperature (°C)
- Ti = Internal cabinet temperature (°C)

DIMENSIONS

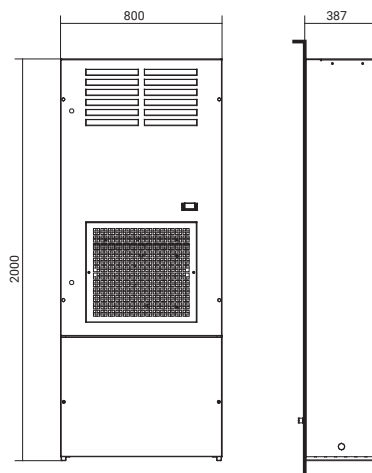

EGO A5

Door- or wall-mount air conditioners

COOLING CAPACITY

14800 - 15150 W



Features	UoM	EGO A5MTEB	EGO A5NTEB
Cooling capacity EN14511 - A35A35	W	14800	15150
Cooling capacity EN14511 - A35A50	W	11300	11600
Power supply	V ~ Hz	400 3~ 50	460 3~ 60
Width - Height - Depth	mm	800 - 2000 - 550	800 - 2000 - 550
Max current	A	11	11.8
Inrush current	A	49	51
T Fuse	A	20	20
Power draw EN14511 - A35A35	W	5750	6580
Power draw EN14511 - A35A50	W	6900	7760
Electrical connection	-	Cable L = 3 m	Cable L = 3 m
R410A Refrigerant	kg	3.5	3.5
Cabinet air fan capacity	m ³ /h	4300	4300
Internal temperature range	°C	20-45	20-45
Temperature regulation	-	Electronic thermostat, factory set to 35°C	
External temperature range	°C	20-50	20-50
EN60529 ingress protection - cabinet side	-	IP54	IP54
Noise level	dB (A)	67	67
Weight	kg	240	240
Conformity	-	CE	CE

PERFORMANCE (EGO A5MTEB)

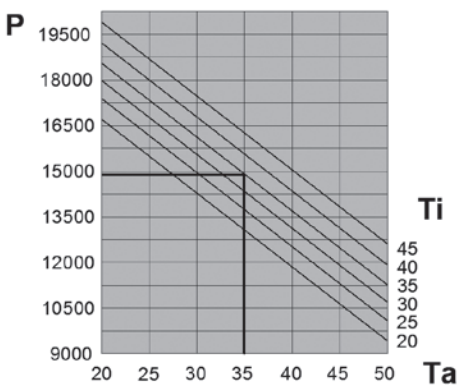

DIMENSIONS

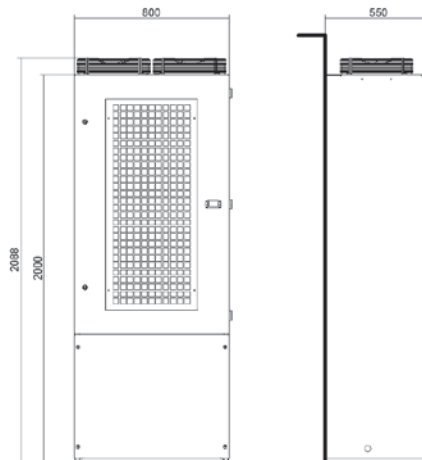

- P = Cooling capacity (W)
- Ta = Ambient Temperature (°C)
- Ti = Internal cabinet temperature (°C)

FILTERS



Models	Item code	Quantity per pack
EGO60	C15000175	5
EGO80-A0	C15000188	5

AAEFP/AADFP

PU foam filter for air conditioners

nVent air conditioners are designed not to require maintenance and are supplied without filters for the external air intake. However, when the ambient air is particularly contaminated by oily aerosols or particles, users can choose to insert a filter in the space provided at the rear of the intake grille. These filters are made from an alveolar polyurethane foam with highly stable mechanical and chemical properties.



Models	Item code	Quantity per pack
EGO60	C15000176	1
EGO80-A0	C15000189	1

AAEFM/AADFM

Regenerable air filters for air conditioners

In extreme environmental conditions, the air conditioners can be fitted with metal air filters. They provide less efficient filtration than the PU foam filters, but have the advantage that they are regenerable. They can be cleaned with degreaser and reused as many times as the user wishes. They are made from an aluminium mesh.

DEK

Roof-mount air conditioners

Refrigerant Gas

Air conditioners all come pre-charged with R134a refrigerant

Wide Range of Power Outputs

The available power outputs range from 410 to 3850 W, covering most electrical cabinet cooling requirements in an extremely compact size.

Protection from Condensate

Great attention has been paid to protecting the cabinet from condensate. Inside the air conditioner is a stainless-steel tray in which the condensate is collected, before being drained off through a service hose and second safety hose.

Electronic Regulation

All nVent air conditioning systems are equipped with electronic regulation as standard.

Quick Installation

Installation is made quick by the simplicity of the drilling to be performed on the cabinet panel, and by the fastening systems.

Reduced Maintenance

All units are designed to prevent clogging by solid contaminants present in the ambient air.



DEK04

Roof-mount air conditioners

COOLING CAPACITY

410 W

PERFORMANCE

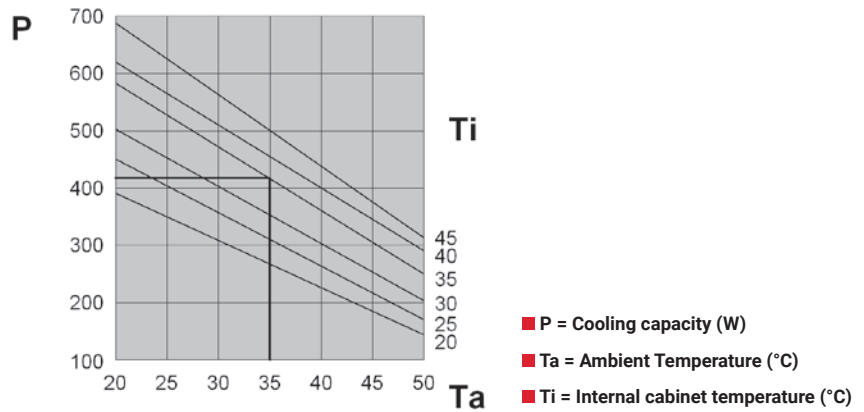
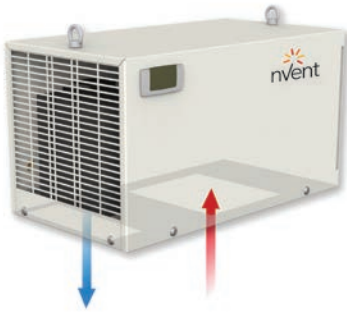

DIMENSIONS

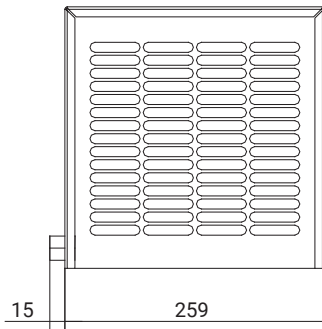

Features	UoM	DEK04BTUB	DEK04CTOB
Cooling capacity EN14511 - A35A35	W	410	410
Cooling capacity EN14511 - A35A50	W	240	240
Power supply	V ~ Hz	230 1~ 50-60	115 1~ 50-60
Width - Height - Depth	mm	259 - 260 - 481	259 - 260 - 481
Max current	A	1.5	2.9
Inrush current	A	4	10
T Fuse	A	4	6
Power draw EN14511 - A35A35	W	230	280
Power draw EN14511 - A35A50	W	290	325
Electrical connection	-	4-pin plug	4-pin plug
Cabinet air fan capacity	m ³ /h	235	235
Internal temperature range	°C	20-45	20-45
External temperature range	°C	20-55*	20-50
EN60529 ingress protection - cabinet side	-	IP54	IP54
Noise level	dB (A)	65	60
Weight	kg	18	19
Conformity	-	CE C  us	CE

* 50°C at 60 Hz

DEK08

Roof-mount air conditioners

COOLING CAPACITY

820 W

PERFORMANCE

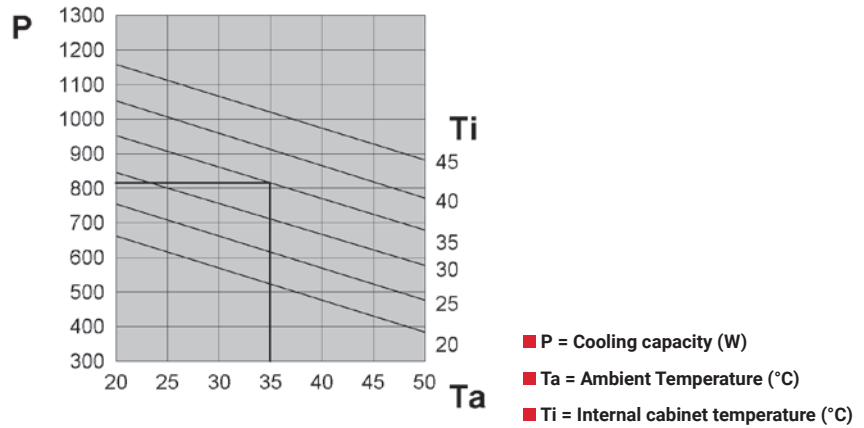

DIMENSIONS

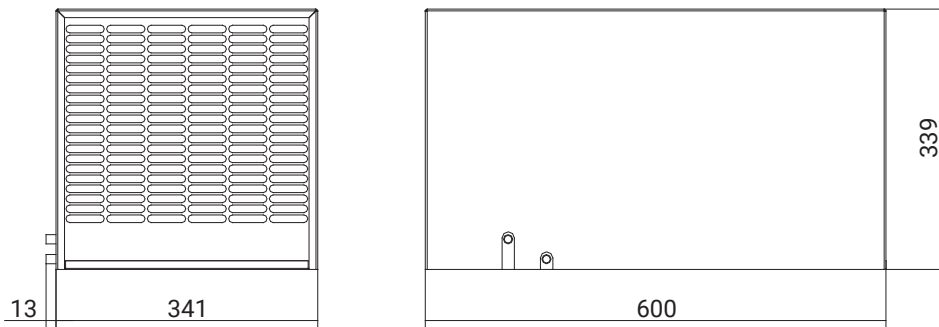

Features	UoM	DEK08BTUB	DEK08CT0B	DEK08GT0B
Cooling capacity EN14511 - A35A35	W	820	820	820
Cooling capacity EN14511 - A35A50	W	680	680	680
Power supply	V ~ Hz	230 1~ 50-60	115 1~ 50-60	400/440 2~ 50-60
Width - Height - Depth	mm	341 - 339 - 600	341 - 339 - 600	341 - 339 - 600
Max current	A	3.5	5.7	1.7
Inrush current	A	12	19	7
T Fuse	A	6	10	4
Power draw EN14511 - A35A35	W	520	520	520
Power draw EN14511 - A35A50	W	590	570	570
Electrical connection	-	4-pin plug	4-pin plug	4-pin plug
Cabinet air fan capacity	m ³ /h	570	570	570
Internal temperature range	°C	20-45	20-45	20-45
External temperature range	°C	20-55*	20-50	20-50
EN60529 ingress protection - cabinet side	-	IP54	IP54	IP54
Noise level	dB (A)	65	62	62
Weight	kg	23	24	24
Conformity	-	CE c RU us	CE	CE

* 50°C at 60 Hz

DEK12

Roof-mount air conditioners

COOLING CAPACITY

1150 W

PERFORMANCE

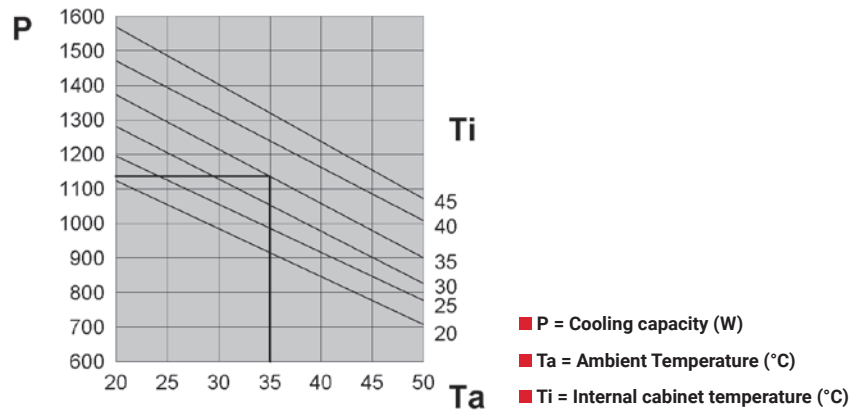

DIMENSIONS

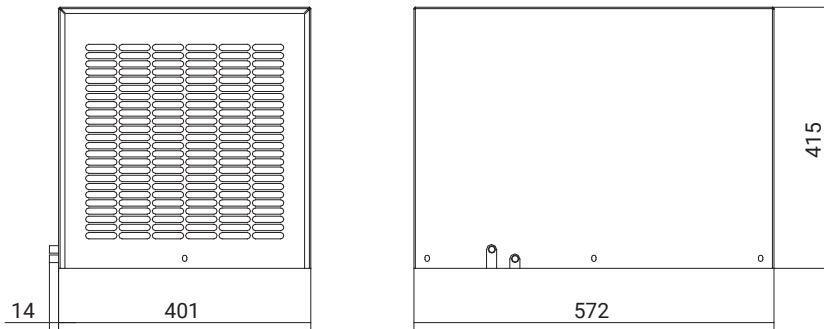

Features	UoM	DEK12BTUB	DEK12CT0B	DEK12GT0B
Cooling capacity EN14511 - A35A35	W	1150	1150	1150
Cooling capacity EN14511 - A35A50	W	900	900	900
Power supply	V ~ Hz	230 1~ 50-60	115 1~ 50-60	400/440 2~ 50-60
Width - Height - Depth	mm	401 - 415 - 572	401 - 415 - 572	401 - 415 - 572
Max current	A	4	6.4	2.2
Inrush current	A	11	22	8
T Fuse	A	6	12	6
Power draw EN14511 - A35A35	W	570	560	560
Power draw EN14511 - A35A50	W	690	670	670
Electrical connection	-	4-pin plug	4-pin plug	4-pin plug
Cabinet air fan capacity	m ³ /h	570	570	570
Internal temperature range	°C	20-45	20-45	20-45
External temperature range	°C	20-50	20-50	20-50
EN60529 ingress protection - cabinet side	-	IP54	IP54	IP54
Noise level	dB (A)	65	65	65
Weight	kg	40	42	42
Conformity	-	CE C RA us	CE	CE

* 50°C at 60 Hz

DEK15

Roof-mount air conditioners

COOLING CAPACITY

1550 W

PERFORMANCE

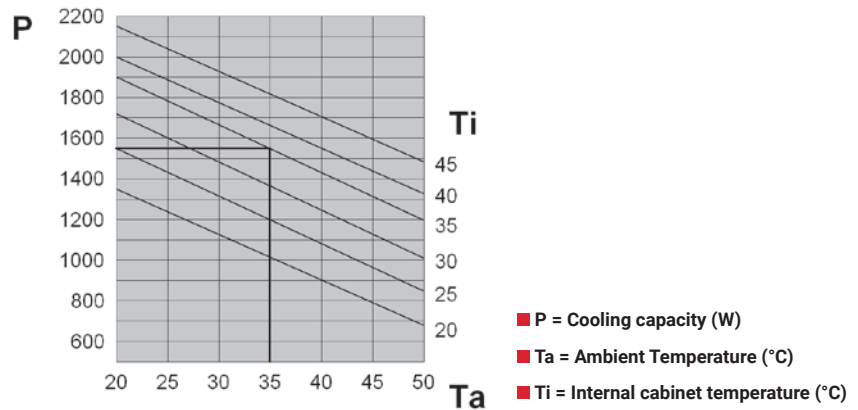

DIMENSIONS

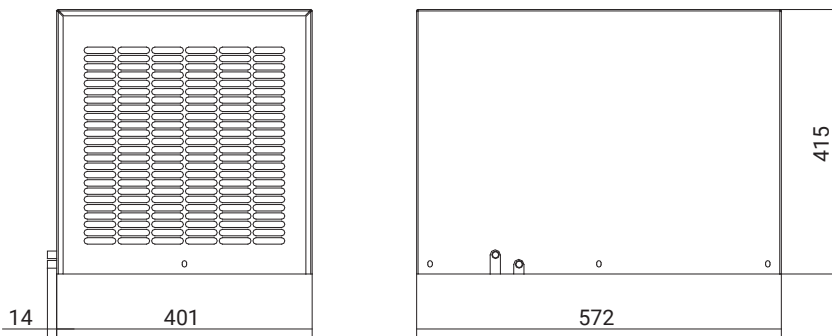

Features	UoM	DEK15BTUB	DEK15CT0B	DEK15GT0B
Cooling capacity EN14511 - A35A35	W	1550	1550	1550
Cooling capacity EN14511 - A35A50	W	1200	1200	1200
Power supply	V ~ Hz	230 1~ 50-60	115 1~ 50-60	400/440 2~ 50-60
Width - Height - Depth	mm	401 - 415 - 572	401 - 415 - 572	401 - 415 - 572
Max current	A	5.5	10	2.8
Inrush current	A	18	39	9.6
T Fuse	A	10	18	6
Power draw EN14511 - A35A35	W	830	820	820
Power draw EN14511 - A35A50	W	960	940	940
Electrical connection	-	4-pin plug	4-pin plug	4-pin plug
Cabinet air fan capacity	m ³ /h	860	860	860
Internal temperature range	°C	20-45	20-45	20-45
External temperature range	°C	20-50	20-50	20-50
EN60529 ingress protection - cabinet side	-	IP54	IP54	IP54
Noise level	dB (A)	65	65	65
Weight	kg	44	46	46
Conformity	-	CE CULUS	CE	CE

* 50°C at 60 Hz

DEK20

Roof-mount air conditioners

COOLING CAPACITY

2050 W

PERFORMANCE

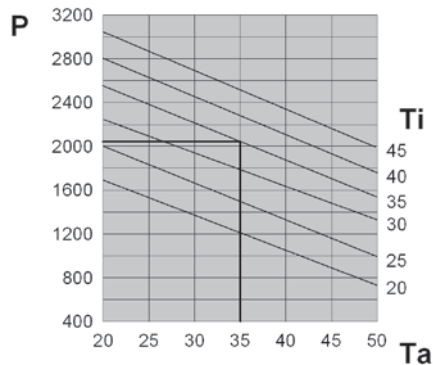

- P = Cooling capacity (W)
- Ta = Ambient Temperature (°C)
- Ti = Internal cabinet temperature (°C)

DIMENSIONS

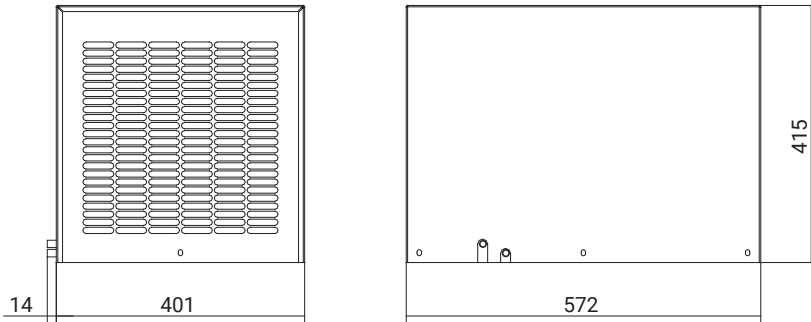

Features	UoM	DEK20BT0B	DEK20CT0B	DEK20LT0B	DEK20NTUB
Cooling capacity EN14511 - A35A35	W	2050	2050	2050	2050
Cooling capacity EN14511 - A35A50	W	1560	1560	1560	1560
Power supply	V ~ Hz	230 1~ 50-60	115 1~ 50-60	400 3~ 50-60	460 3~ 60
Width - Height - Depth	mm	401 - 415 - 572	401 - 415 - 572	401 - 415 - 572	401 - 415 - 572
Max current	A	6	13.2	1.9	2.1
Inrush current	A	24	48	10	10
T Fuse	A	10	20	4	6
Power draw EN14511 - A35A35	W	1150	1220	990	1060
Power draw EN14511 - A35A50	W	1250	1320	1190	1290
Electrical connection	-	4-pin plug	4-pin plug	4-pin plug	4-pin plug
Cabinet air fan capacity	m ³ /h	1050	1050	1050	1050
Internal temperature range	°C	20-45	20-45	20-45	20-45
External temperature range	°C	20-55*	20-50	20-50	20-50
EN60529 ingress protection - cabinet side	-	IP54	IP54	IP54	IP54
Noise level	dB (A)	65	65	65	65
Weight	kg	50	56	52	52
Conformity	-	CE	CE	CE	CE c RA us

* 50°C at 60 Hz

DEK30

Roof-mount air conditioners

COOLING CAPACITY

2900 W

PERFORMANCE

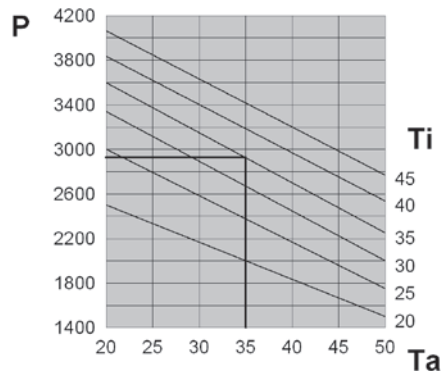
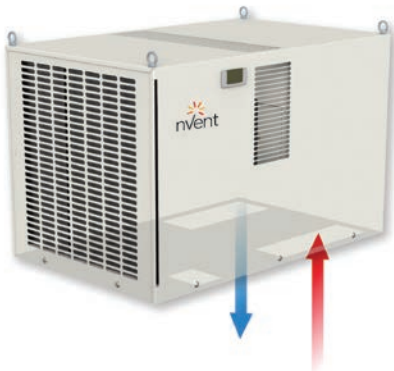

- P = Cooling capacity (W)
- Ta = Ambient Temperature (°C)
- Ti = Internal cabinet temperature (°C)

DIMENSIONS

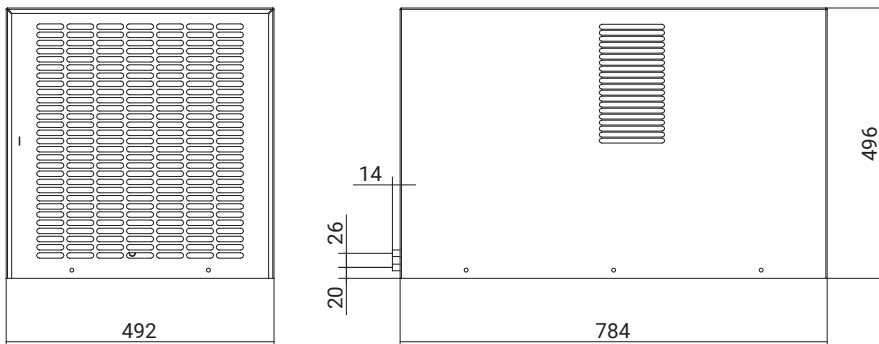

Features	UoM	DEK30BT0B	DEK30LT0B	DEK30NTUB
Cooling capacity EN14511 - A35A35	W	2900	2900	2900
Cooling capacity EN14511 - A35A50	W	2250	2250	2250
Power supply	V ~ Hz	230 1~ 50-60	400 3~ 50-60	460 3~ 60
Width - Height - Depth	mm	492 - 496 - 784	492 - 496 - 784	492 - 496 - 784
Max current	A	8.2	2.5	3.3
Inrush current	A	38.4	15.7	15.7
T Fuse	A	16	6	6
Power draw EN14511 - A35A35	W	1350	1210	1310
Power draw EN14511 - A35A50	W	1610	1450	1750
Electrical connection	-	4-pin plug	4-pin plug	4-pin plug
Cabinet air fan capacity	m ³ /h	860	860	860
Internal temperature range	°C	20-45	20-45	20-45
External temperature range	°C	20-50	20-50	20-50
EN60529 ingress protection - cabinet side	-	IP54	IP54	IP54
Noise level	dB (A)	75	75	75
Weight	kg	80	83	83
Conformity	-	CE	CE	CE c RU US

DEK40

Roof-mount air conditioners

COOLING CAPACITY

3850 W

PERFORMANCE

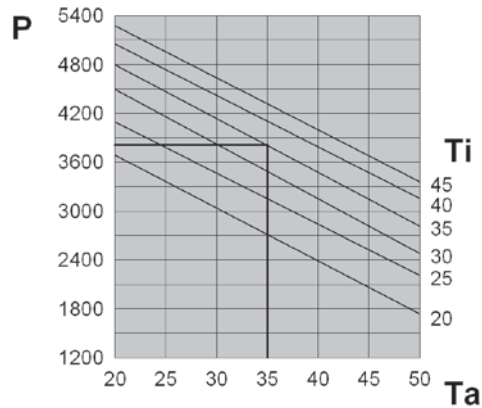

DIMENSIONS

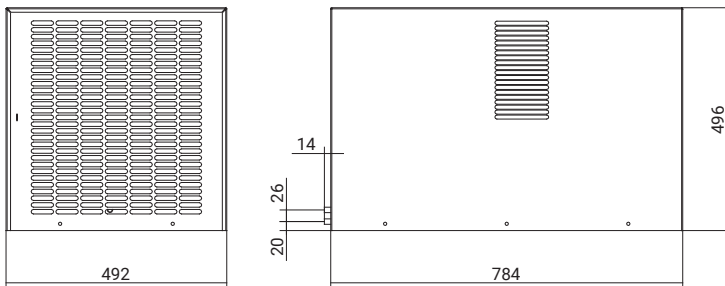

Features	UoM	DEK40BT0B	DEK40LT0B	DEK40NTUB
Cooling capacity EN14511 - A35A35	W	3850	3850	3850
Cooling capacity EN14511 - A35A50	W	2870	2870	2870
Power supply	V ~ Hz	230 1~ 50-60	400 3~ 50-60	460 3~ 60
Width - Height - Depth	mm	492 - 496 - 784	492 - 496 - 784	492 - 496 - 784
Max current	A	9	3.6	4.3
Inrush current	A	38.2	17	17
T Fuse	A	18	6	6
Power draw EN14511 - A35A35	W	1690	1790	1950
Power draw EN14511 - A35A50	W	1950	2010	2160
Electrical connection	-	4-pin plug	4-pin plug	4-pin plug
Cabinet air fan capacity	m ³ /h	1450	1450	1450
Internal temperature range	°C	20-45	20-45	20-45
External temperature range	°C	20-50	20-50	20-50
EN60529 ingress protection - cabinet side	-	IP54	IP54	IP54
Noise level	dB (A)	75	75	75
Weight	kg	83	86	86
Conformity	-	CE	CE	CE c RU US

FILTERS



Models	Item code	Quantity per pack
DEK04	C15000171	5
DEK08	C15000173	5
DEK12-15-20	AADFP12	5
DEK30-40	AADFP30	5

AAEFP/AADFP

PU foam filter for air conditioners

nVent air conditioners are designed not to require maintenance and are supplied without filters for the external air intake. However, when the ambient air is particularly contaminated by oily aerosols or particles, users can choose to insert a filter in the space provided at the rear of the intake grille. These filters are made from an alveolar polyurethane foam with highly stable mechanical and chemical properties.



Models	Item code	Quantity per pack
DEK04	C15000172	1
DEK08	C15000174	1
DEK12-15-20	AADFM12	1
DEK30-40	AADFM30	1

AAEFM/AADFM

Regenerable air filters for air conditioners

In extreme environmental conditions, the air conditioners can be fitted with metal air filters. They provide less efficient filtration than the PU foam filters, but have the advantage that they are regenerable. They can be cleaned with degreaser and reused as many times as the user wishes.

They are made from an aluminium mesh.

NOX

Wall-mount air conditioners for outdoor applications



GAS

Air conditioners all come pre-charged with R134a refrigerant



Integrated Modbus

All air conditioners with NOX-i40 can be provided with MODBUS RTU RS485 connection on request.



Advanced sequencing

All units are equipped with connection to sequence the operation of two air conditioners. This option allows back-up operation and distribution of operating hours.



Advanced microport

Customers can easily program whether or not to lock the internal fan when the microport opens.



ECO mode

Standard feature on the entire range to optimise electricity use under low working load conditions.



°C / °F

Change only one parameter to go from Celsius to Fahrenheit.



Predictive maintenance

An advanced system enables the air conditioner to self-learn and alert the user when maintenance is due.



Service mode

Runs a simple check procedure to ensure the air conditioner is working properly; useful during installation.



Humidity control

This option (supplied on request) uses a humidistat to control the humidity inside the cabinet; ideal for applications in tropical areas.

EC Fans

Available on request, electronic fans increase air conditioner efficiency by further reducing energy consumption and related operating costs.



Low-noise version

Available on request, the version with reduced modulated speed fans enables low-noise operation in outdoor residential or commercial applications.



NOX06

Wall-mount air conditioners for outdoor applications

COOLING CAPACITY

720 W

DIMENSIONS

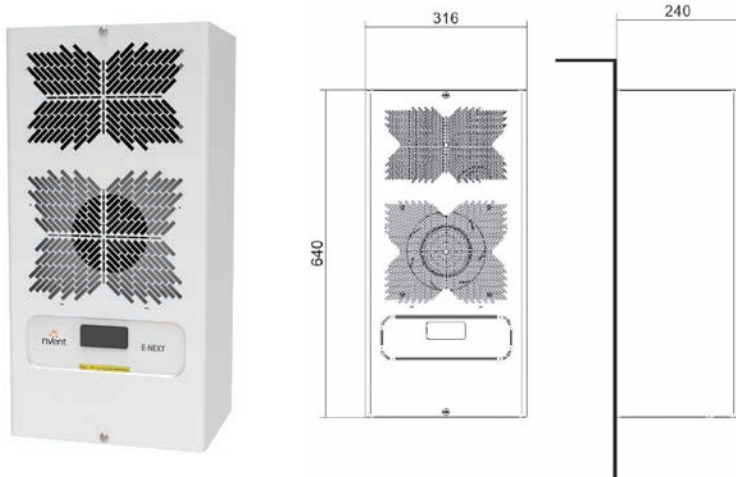

PERFORMANCE

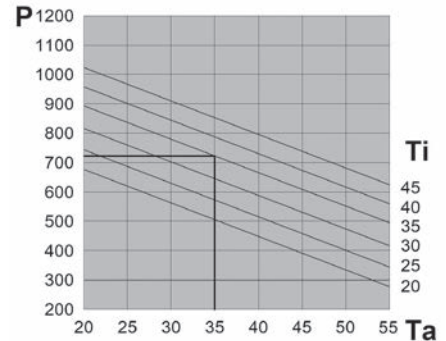

- P = Cooling capacity (W)
- Ta = Ambient Temperature (°C)
- Ti = Internal cabinet temperature (°C)

Features	UoM	NOX06K0E1C00000	NOX06B0E1U00000	NOX06C0E1U00000
Cooling capacity EN14511 - A35A35	W	720	720	720
Cooling capacity EN14511 - A35A50	W	555	555	555
Power supply	V ~ Hz	400/460 - 2 - 50/60	230 - 1 - 50/60	115 - 1 - 60
Width - Height - Depth	mm	316 - 640 - 240	316 - 640 - 240	316 - 640 - 240
Max current	A	1.3	2.3	4.3
Inrush current	A	6.3	10.9	22.2
T Fuse	A	4	6	8
Power draw EN14511 - A35A35	W	380	380	420
Power draw EN14511 - A35A50	W	450	450	500
Electrical connection	-	4-pin plug	4-pin plug	4-pin plug
Cabinet air fan capacity	m³/h	305	305	305
Internal temperature range	°C	20-45	20-45	20-45
Temperature regulation	-	Electronic thermostat TX-i40 factory set to 35°C, with 3 m cable and DIN rail installation kit		
External temperature range	°C	-20 - +55	-20 - +55	-20 - +55
Ingress protection - cabinet side	-	IP55	NEMA TYPE 4/4X	NEMA TYPE 4/4X
Noise level	dB (A)	65	65	65
Weight	kg	26	24	24
Conformity	-	CE UK	UL LISTED CE UK	UL LISTED CE UK

* Type 4X only in stainless steel framework version

NOX08

Wall-mount air conditioners for outdoor applications

COOLING CAPACITY

880 W

DIMENSIONS

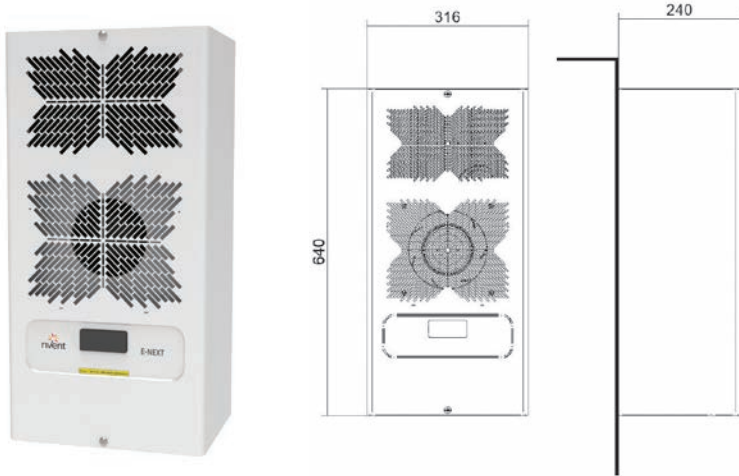

PERFORMANCE

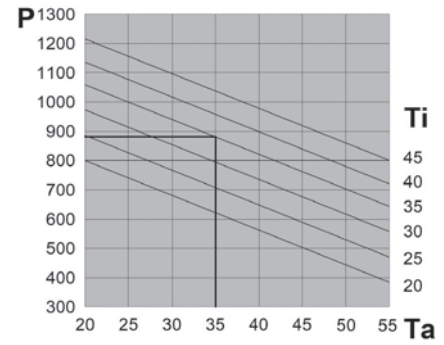

- P = Cooling capacity (W)
- Ta = Ambient Temperature (°C)
- Ti = Internal cabinet temperature (°C)

Features	UoM	NOX08K0E1C00000	NOX08B0E1U00000	NOX08C0E1U00000
Cooling capacity EN14511 - A35A35	W	880	880	880
Cooling capacity EN14511 - A35A50	W	705	705	705
Power supply	V ~ Hz	400/460 - 2 - 50/60	230 - 1 - 50/60	115 - 1 - 60
Width - Height - Depth	mm	316 - 640 - 240	316 - 640 - 240	316 - 640 - 240
Max current	A	1.4	2.4	4.2
Inrush current	A	7.4	12.9	22.2
T Fuse	A	4	6	8
Power draw EN14511 - A35A35	W	450	450	430
Power draw EN14511 - A35A50	W	520	520	540
Electrical connection	-	4-pin plug	4-pin plug	4-pin plug
Cabinet air fan capacity	m³/h	325	325	325
Internal temperature range	°C	20-45	20-45	20-45
Temperature regulation	-	Electronic thermostat TX-i40 factory set to 35°C, with 3 m cable and DIN rail installation kit		
External temperature range	°C	-20 - +55	-20 - +55	-20 - +55
Ingress protection - cabinet side	-	IP55	NEMA TYPE 4/4X	NEMA TYPE 4/4X
Noise level	dB (A)	65	65	65
Weight	kg	27	25	25
Conformity	-	CE UK CA	UL CE UK CA	UL CE UK CA

* Type 4X only in stainless steel framework version

NOX10

Wall-mount air conditioners for outdoor applications

COOLING CAPACITY

1000 W

DIMENSIONS

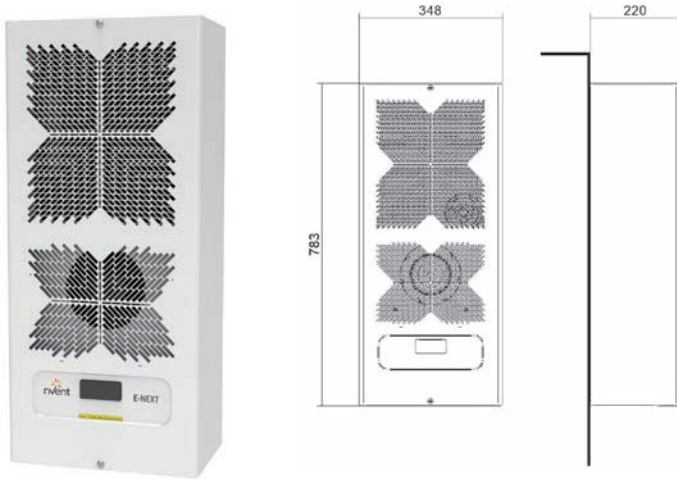

PERFORMANCE

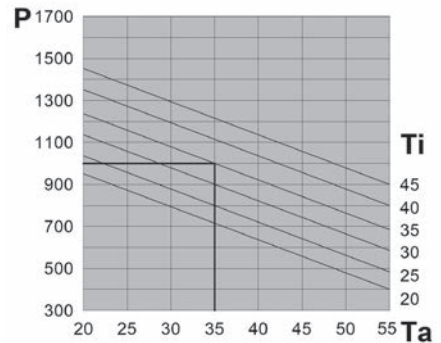

- P = Cooling capacity (W)
- Ta = Ambient Temperature (°C)
- Ti = Internal cabinet temperature (°C)

Features	UoM	NOX10B0E1U00000	NOX10C0E1U00000	NOX10K0E1U00000
Cooling capacity EN14511 - A35A35	W	1000	1000	1000
Cooling capacity EN14511 - A35A50	W	760	760	760
Power supply	V ~ Hz	230 - 1 - 50/60	115 - 1 - 60	400/460 - 2 - 50/60
Width - Height - Depth	mm	348 - 783 - 220	348 - 783 - 220	348 - 783 - 220
Max current	A	3	5.7	1.7
Inrush current	A	13.1	28	7.5
T Fuse	A	6	10	4
Power draw EN14511 - A35A35	W	500	570	500
Power draw EN14511 - A35A50	W	600	670	600
Electrical connection	-	4-pin plug	4-pin plug	4-pin plug
Cabinet air fan capacity	m ³ /h	540	540	540
Internal temperature range	°C	20-45	20-45	20-45
Temperature regulation	-	Electronic thermostat TX-i40 factory set to 35°C, with 3 m cable and DIN rail installation kit		
External temperature range	°C	-20 - +55	-20 - +55	-20 - +55
Ingress protection - cabinet side	-	NEMA TYPE 4/4X	NEMA TYPE 4/4X	NEMA TYPE 4/4X
Noise level	dB (A)	65	65	65
Weight	kg	27	27	29
Conformity	-			

* Type 4X only in stainless steel framework version

NOX12

Wall-mount air conditioners for outdoor applications

COOLING CAPACITY

1250 W

DIMENSIONS

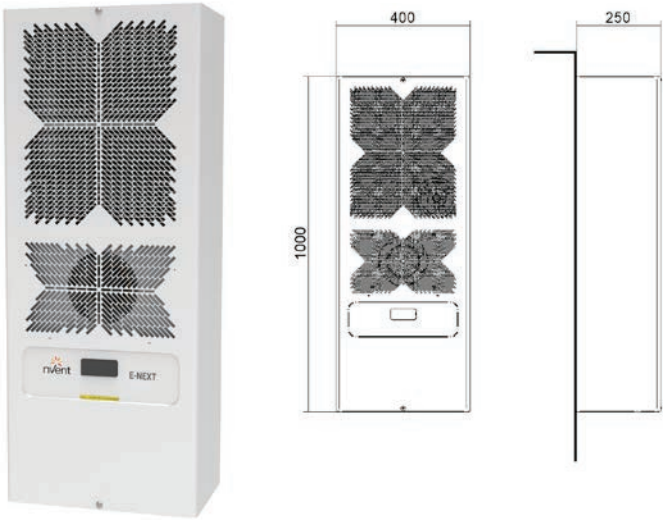

PERFORMANCE

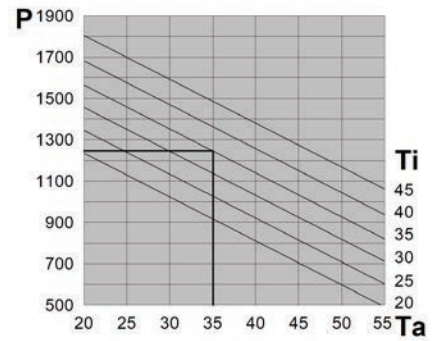

- P = Cooling capacity (W)
- Ta = Ambient Temperature (°C)
- Ti = Internal cabinet temperature (°C)

Features	UoM	NOX12K0E1C00000	NOX12B0E1U00000	NOX12C0E1U00000
Cooling capacity EN14511 - A35A35	W	1250	1250	1250
Cooling capacity EN14511 - A35A50	W	930	930	930
Power supply	V ~ Hz	400/460 - 2 - 50/60	230 - 1 - 50/60	115 - 1 - 60
Width - Height - Depth	mm	400 - 1000 - 250	400 - 1000 - 250	400 - 1000 - 250
Max current	A	1.8	3.2	6.1
Inrush current	A	9.8	17.1	28
T Fuse	A	4	6	10
Power draw EN14511 - A35A35	W	590	590	620
Power draw EN14511 - A35A50	W	680	680	760
Electrical connection	-	4-pin plug	4-pin plug	4-pin plug
Cabinet air fan capacity	m³/h	540	540	540
Internal temperature range	°C	20-45	20-45	20-45
Temperature regulation	-	Electronic thermostat TX-i40 factory set to 35°C, with 3 m cable and DIN rail installation kit		
External temperature range	°C	-20 - +55	-20 - +55	-20 - +55
Ingress protection - cabinet side	-	IP55	NEMA TYPE 4/4X	NEMA TYPE 4/4X
Noise level	dB (A)	65	65	65
Weight	kg	41	39	39
Conformity	-	CE UK	UL LISTED CE UK	UL LISTED CE UK

* Type 4X only in stainless steel framework version

NOX16

Wall-mount air conditioners for outdoor applications

COOLING CAPACITY

1600 W

DIMENSIONS

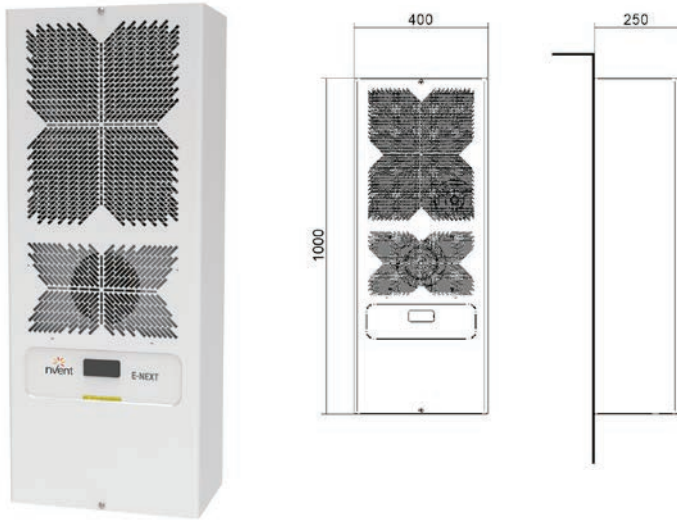

PERFORMANCE

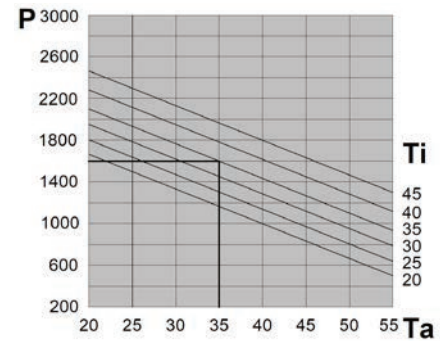

- P = Cooling capacity (W)
- Ta = Ambient Temperature (°C)
- Ti = Internal cabinet temperature (°C)

Features	UoM	NOX16B0E1U00000	NOX16C0E1U00000	NOX16K0E1U00000
Cooling capacity EN14511 - A35A35	W	1600	1600	1600
Cooling capacity EN14511 - A35A50	W	1100	1100	1100
Power supply	V ~ Hz	230 - 1 - 50/60	115 - 1 - 60	400/460 - 2 - 50/60
Width - Height - Depth	mm	400 - 1000 - 250	400 - 1000 - 250	400 - 1000 - 250
Max current	A	4.3	8.2	2.4
Inrush current	A	19.7	42	10.2
T Fuse	A	8	16	6
Power draw EN14511 - A35A35	W	720	830	720
Power draw EN14511 - A35A50	W	820	960	820
Electrical connection	-	4-pin plug	4-pin plug	4-pin plug
Cabinet air fan capacity	m ³ /h	540	540	540
Internal temperature range	°C	20-45	20-45	20-45
Temperature regulation	-	Electronic thermostat TX-i40 factory set to 35°C, with 3 m cable and DIN rail installation kit		
External temperature range	°C	-20 - +55	-20 - +55	-20 - +55
Ingress protection - cabinet side	-	NEMA TYPE 4/4X	NEMA TYPE 4/4X	NEMA TYPE 4/4X
Noise level	dB (A)	65	65	65
Weight	kg	41	41	43
Conformity	-			

* Type 4X only in stainless steel framework version

NOX20

Wall-mount air conditioners for outdoor applications

COOLING CAPACITY

2000 W

DIMENSIONS

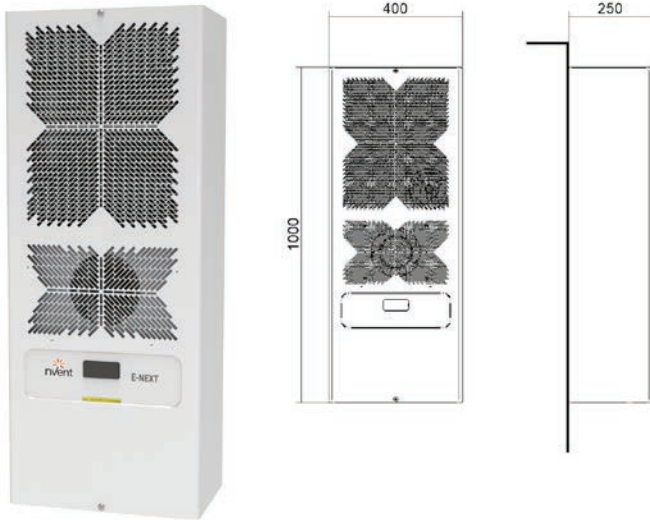

PERFORMANCE

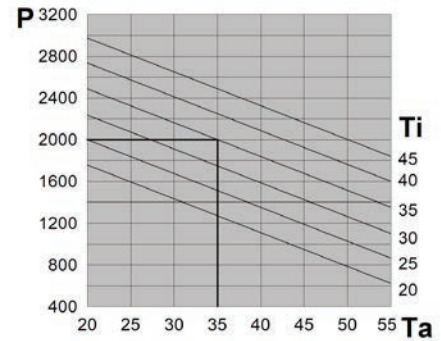

- P = Cooling capacity (W)
- Ta = Ambient Temperature (°C)
- Ti = Internal cabinet temperature (°C)

Features	UoM	NOX20B0E1U00000	NOX20C0E1U00000	NOX20H0E1U00000
Cooling capacity EN14511 - A35A35	W	2000	2000	2000
Cooling capacity EN14511 - A35A50	W	1500	1500	1500
Power supply	V ~ Hz	230 - 1 - 50/60	115 - 1 - 60	400/3/50 460/3/60
Width - Height - Depth	mm	400 - 1000 - 250	400 - 1000 - 250	400 - 1000 - 250
Max current	A	4.8	11.3	1.6
Inrush current	A	21.8	56.8	12
T Fuse	A	10	16	4
Power draw EN14511 - A35A35	W	990	1170	870
Power draw EN14511 - A35A50	W	1130	1360	1050
Electrical connection	-	4-pin plug	4-pin plug	4-pin plug
Cabinet air fan capacity	m ³ /h	540	540	540
Internal temperature range	°C	20-45	20-45	20-45
Temperature regulation	-	Electronic thermostat TX-i40 factory set to 35°C, with 3 m cable and DIN rail installation kit		
External temperature range	°C	-20 - +55	-20 - +55	-20 - +55
Ingress protection - cabinet side	-	NEMA TYPE 4/4X	NEMA TYPE 4/4X	NEMA TYPE 4/4X
Noise level	dB (A)	77	77	77
Weight	kg	42	42	44
Conformity	-			

* Type 4X only in stainless steel framework version

NOX30

Wall-mount air conditioners for outdoor applications

COOLING CAPACITY

3000 W

DIMENSIONS

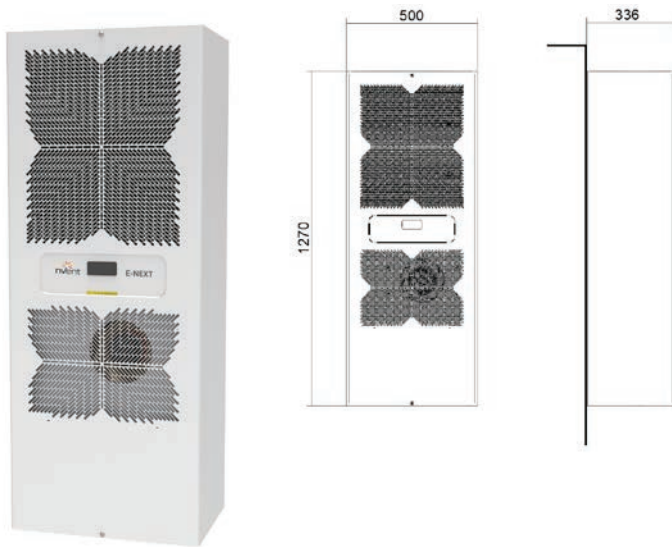

PERFORMANCE

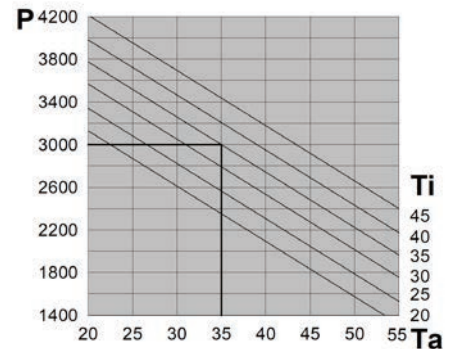

- P = Cooling capacity (W)
- Ta = Ambient Temperature (°C)
- Ti = Internal cabinet temperature (°C)

Features	UoM	NOX30B0E1U00000	NOX30H0E1U00000
Cooling capacity EN14511 - A35A35	W	3000	3000
Cooling capacity EN14511 - A35A50	W	2210	2210
Power supply	V ~ Hz	230 - 1 - 50/60	400/3/50 - 460/3/60
Width - Height - Depth	mm	500 - 1270 - 336	500 - 1270 - 336
Max current	A	5.2	2.4
Inrush current	A	35	20
T Fuse	A	10	6
Power draw EN14511 - A35A35	W	1190	1140
Power draw EN14511 - A35A50	W	1380	1350
Electrical connection	-	4-pin plug	4-pin plug
Cabinet air fan capacity	m³/h	1500	1500
Internal temperature range	°C	20-45	20-45
Temperature regulation	-	Electronic thermostat TX-i40 factory set to 35°C, with 3 m cable and DIN rail installation kit	
External temperature range	°C	-20 - +55	-20 - +55
Ingress protection - cabinet side	-	NEMA TYPE 4/4X	NEMA TYPE 4/4X
Noise level	dB (A)	70	70
Weight	kg	66	70
Conformity	-		

* Type 4X only in stainless steel framework version

NOX40

Wall-mount air conditioners for outdoor applications

COOLING CAPACITY

3850 W

DIMENSIONS

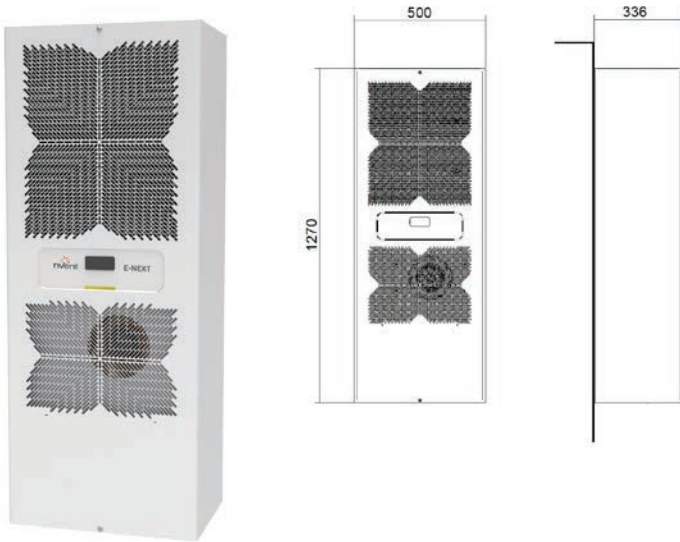

PERFORMANCE

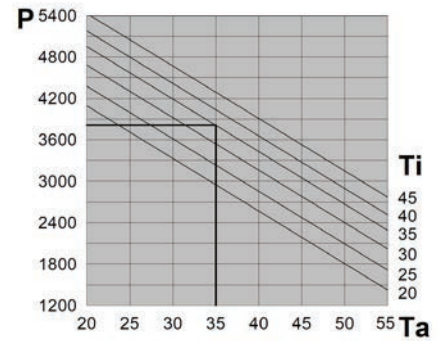

- P = Cooling capacity (W)
- Ta = Ambient Temperature (°C)
- Ti = Internal cabinet temperature (°C)

Features	UoM	NOX40B0E1U00000	NOX40H0E1U00000
Cooling capacity EN14511 - A35A35	W	3850	3850
Cooling capacity EN14511 - A35A50	W	2650	2650
Power supply	V ~ Hz	230 - 1 - 50/60	400/3/50 - 460/3/60
Width - Height - Depth	mm	500 - 1270 - 336	500 - 1270 - 336
Max current	A	7.8	3.6
Inrush current	A	37	18
T Fuse	A	16	8
Power draw EN14511 - A35A35	W	1670	1780
Power draw EN14511 - A35A50	W	1980	2050
Electrical connection	-	4-pin plug	4-pin plug
Cabinet air fan capacity	m ³ /h	1500	1500
Internal temperature range	°C	20-45	20-45
Temperature regulation	-	Electronic thermostat TX-i40 factory set to 35°C, with 3 m cable and DIN rail installation kit	
External temperature range	°C	-20 - +55	-20 - +55
Ingress protection - cabinet side	-	NEMA TYPE 4/4X	NEMA TYPE 4/4X
Noise level	dB (A)	70	70
Weight	kg	70	74
Conformity	-		

* Type 4X only in stainless steel framework version

NOX60

Wall-mount air conditioners for outdoor applications

COOLING CAPACITY

5400 W

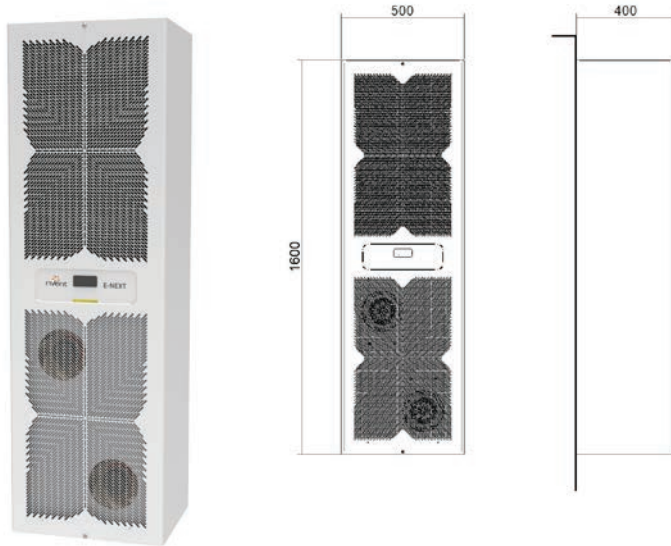

DIMENSIONS

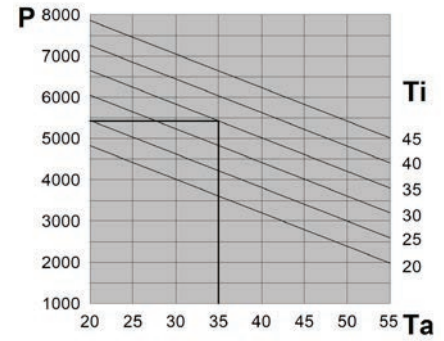

PERFORMANCE



- P = Cooling capacity (W)
- Ta = Ambient Temperature (°C)
- Ti = Internal cabinet temperature (°C)

Features	UoM	NOX60H0E1U00000
Cooling capacity EN14511 - A35A35	W	5400
Cooling capacity EN14511 - A35A50	W	4200
Power supply	V ~ Hz	400/3/50 - 460/3/60
Width - Height - Depth	mm	500 - 1600 - 400
Max current	A	3.7
Inrush current	A	32
T Fuse	A	8
Power draw EN14511 - A35A35	W	1950
Power draw EN14511 - A35A50	W	2470
Electrical connection	-	4-pin plug
Cabinet air fan capacity	m ³ /h	1500
Internal temperature range	°C	20-45
Temperature regulation	-	Electronic thermostat TX-i40 factory set to 35°C, with 3 m cable and DIN rail installation kit
External temperature range	°C	-20 - +55
Ingress protection - cabinet side	-	NEMA TYPE 4/4X
Noise level	dB (A)	72
Weight	kg	104
Conformity	-	  

* Type 4X only in stainless steel framework version



EMO

Wall-mount air conditioners for outdoor application

Regulation and Safety Devices

EMO air conditioning systems are equipped with electromechanical thermostatic regulation which guarantees maximum reliability even in extreme conditions. The refrigeration circuit is protected by low- and high-pressure safety pressure switches with automatic rearming. A fixed calibration pressure switch with ON/OFF contact manages the condensing fan.

Quick Installation

Installation is made quick by the simplicity of the drilling to be performed on the cabinet panel.

Reduced Maintenance

All units are designed to prevent clogging by solid contaminants present in the ambient air. The condensing coils are protected by a cataphoresis treatment which prevents fouling and corrosion.

Operating Temperature

The possible operating temperatures range from -20 to +55°C. The temperature inside the cabinet can be adjusted from +20 to +46°C (the air conditioner is factory set to +35°C).

Optional Accessories

EMO air conditioners offer various optional accessories:

- stainless-steel framework
- evaporating fan with separate 48 VDC power supply
- tamper-resistant screw kit for front casing closure
- high temperature alarm warning
- common high/low pressure alarm



EMO60

Wall-mount air conditioners for outdoor application

COOLING CAPACITY

5800 - 6050 W



Features	UoM	EMO60MMEB	EMO60NMEB
Cooling capacity EN14511 - A35A35	W	5800	6050
Cooling capacity EN14511 - A35A50	W	4350	4530
Power supply	V ~ Hz	400 3~ 50	460 3~ 60
Width - Height - Depth	mm	600 - 2000 - 387	600 - 2000 - 387
Max current	A	5.9	6.8
Inrush current	A	21.7	23.5
T Fuse	A	8	8
Power draw EN14511 - A35A35	W	2340	2920
Power draw EN14511 - A35A50	W	3880	4520
Electrical connection	-	Cable L = 3 m	Cable L = 3 m
R407C Refrigerant	kg	1.8	1.8
Cabinet air fan capacity	m ³ /h	1450	1450
Internal temperature range	°C	+20 - +45	+20 - +45
Temperature regulation	-	Electromechanical thermostat, factory set to 35°C	
External temperature range	°C	-20 - +50	-20 - +50
EN60529 ingress protection - cabinet side	-	IP54	IP54
Noise level	dB (A)	72	72
Weight	kg	150	150
Conformity	-	CE	CE

PERFORMANCE (EMO60MMEB)

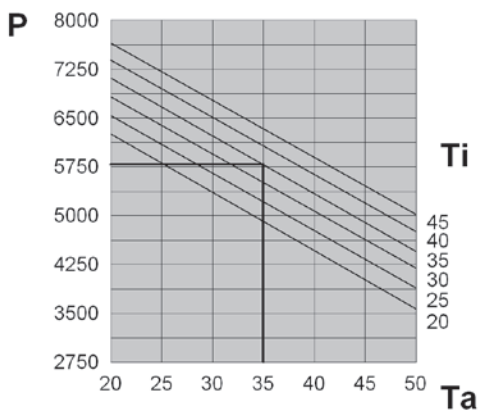

- P = Cooling capacity (W)
- Ta = Ambient Temperature (°C)
- Ti = Internal cabinet temperature (°C)

DIMENSIONS

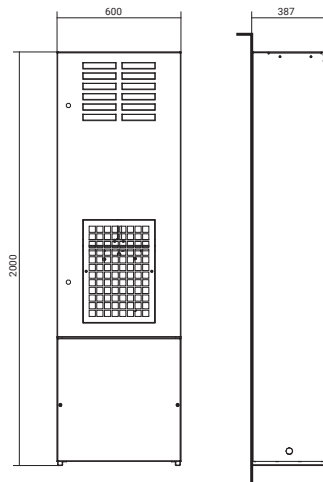

EMO80

Wall-mount air conditioners for outdoor application

COOLING CAPACITY

7600 - 7950 W



Features	UoM	EMO80MMEB	EMO80NMEB
Cooling capacity EN14511 - A35A35	W	7600	7950
Cooling capacity EN14511 - A35A50	W	5700	5930
Power supply	V ~ Hz	400 3~ 50	460 3~ 60
Width - Height - Depth	mm	800 - 2000 - 387	800 - 2000 - 387
Max current	A	8.1	9.3
Inrush current	A	30.7	32.5
T Fuse	A	16	16
Power draw EN14511 - A35A35	W	3300	4035
Power draw EN14511 - A35A50	W	4910	5845
Electrical connection	-	Cable L = 3 m	Cable L = 3 m
R134a Refrigerant	kg	2.8	2.8
Cabinet air fan capacity	m ³ /h	2900	2900
Internal temperature range	°C	+20 - +45	+20 - +45
Temperature regulation	-	Electromechanical thermostat, factory set to 35°C	
External temperature range	°C	-20 - +50	-20 - +50
EN60529 ingress protection - cabinet side	-	IP54	IP54
Noise level	dB (A)	75	75
Weight	kg	160	160
Conformity	-	CE	CE

PERFORMANCE (EMO80MMEB)

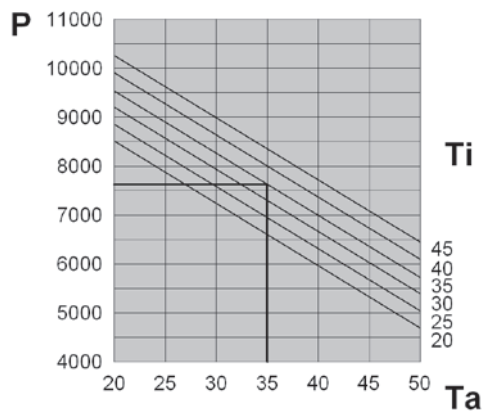

- P = Cooling capacity (W)
- Ta = Ambient Temperature (°C)
- Ti = Internal cabinet temperature (°C)

DIMENSIONS

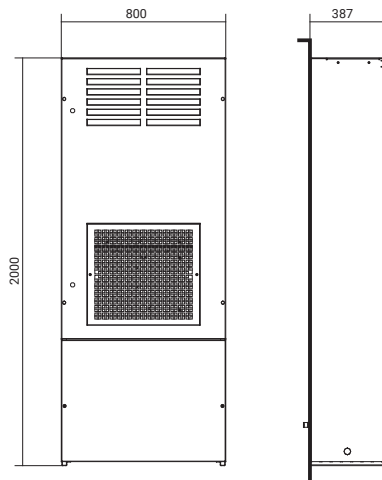

COOLING CAPACITY

9400 - 9850 W



Features	UoM	EMOA0MMEB	EMOA0NMEB
Cooling capacity EN14511 - A35A35	W	9400	9850
Cooling capacity EN14511 - A35A50	W	7000	7350
Power supply	V ~ Hz	400 3~ 50	460 3~ 60
Width - Height - Depth	mm	800 - 2000 - 387	800 - 2000 - 387
Max current	A	9.1	10.3
Inrush current	A	30.7	32.5
T Fuse	A	18	18
Power draw EN14511 - A35A35	W	3650	4380
Power draw EN14511 - A35A50	W	5400	6340
Electrical connection	-	Cable L = 3 m	Cable L = 3 m
R134a Refrigerant	kg	2.3	2.3
Cabinet air fan capacity	m ³ /h	2900	2900
Internal temperature range	°C	+20 - +45	+20 - +45
Temperature regulation	-	Electromechanical thermostat, factory set to 35°C	
External temperature range	°C	-20 - +50	-20 - +50
EN60529 ingress protection - cabinet side	-	IP54	IP54
Noise level	dB (A)	77	77
Weight	kg	180	180
Conformity	-	CE	CE

* IP54 rated exterior electrical connections

PERFORMANCE (EMOA0MMEB)

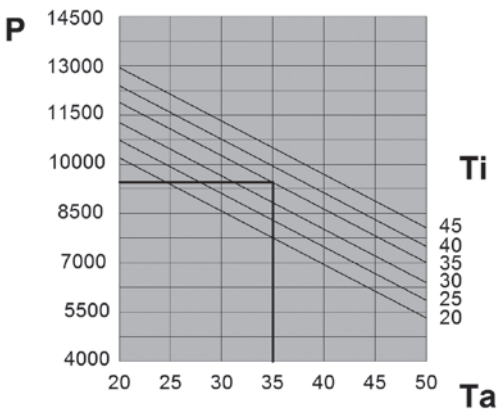

- P = Cooling capacity (W)
- Ta = Ambient Temperature (°C)
- Ti = Internal cabinet temperature (°C)

DIMENSIONS

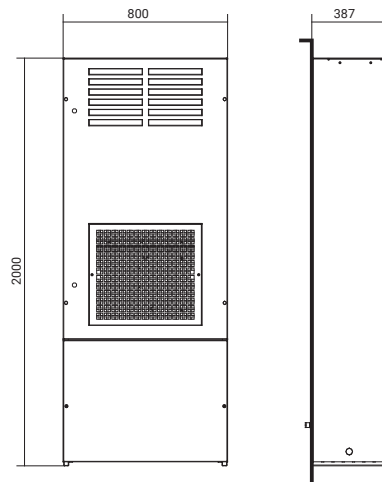

FILTERS



Models	Item code	Quantity per pack
EMO60	C15000175	5
EMO80-A0	C15000188	5

AAEFP/AADFP

PU foam filter for air conditioners

nVent air conditioners are designed not to require maintenance and are supplied without filters for the external air intake. However, when the ambient air is particularly contaminated by oily aerosols or particles, users can choose to insert a filter in the space provided at the rear of the intake grille. These filters are made from an alveolar polyurethane foam with highly stable mechanical and chemical properties.



Models	Item code	Quantity per pack
EMO60	C15000176	1
EMO80-A0	C15000189	1

AAEFM/AADFM

Regenerable air filters for air conditioners

In extreme environmental conditions, the air conditioners can be fitted with metal air filters. They provide less efficient filtration than the PU foam filters, but have the advantage that they are regenerable. They can be cleaned with degreaser and reused as many times as the user wishes.

They are made from an aluminium mesh.

BLU-BIT

Air-water heat exchangers for door/wall and roof installation

High cooling power capacities with reduced unit sizes, completely free from scheduled maintenance. These are the main features of the BLU-BIT range, the best choice of air conditioner when working in extreme temperature environments with dust and oil contamination.

Wide Range of Power Outputs

The range of cooling power outputs ranges from 1000 to 25000 W for the vertical range, while the roof range is represented by a 2500 W model.

No Scheduled Maintenance

The special layout of these machines means they do not require regular/scheduled maintenance (replacement of filters or cleaning of the heat exchanger) to guarantee full operation.

Optimised Protection of the Cabinet

BLU/BIT heat exchangers, thanks to their innovative design combined with the correct application of the self-adhesive sealing gasket, guarantees IP55 ingress protection (EN 60529), meaning they are ideal for particularly contaminated outdoor environments.

Accessories

In order to optimise the heat exchange on the basis of the temperature required inside the enclosure and allow correct condensate management, thermostats can be incorporated to control an ON/OFF solenoid valve which will allow or inhibit the water flow.



BIT25

Air-water heat exchangers for roof installation

COOLING CAPACITY

2500 W



PERFORMANCE

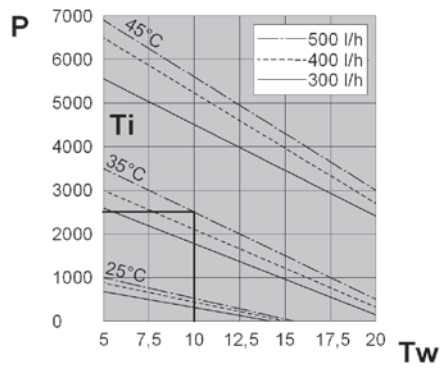

- P = Cooling capacity (W)
- Tw = Water inlet temperature (°C)
- Ti = Internal cabinet temperature (°C)

DIMENSIONS

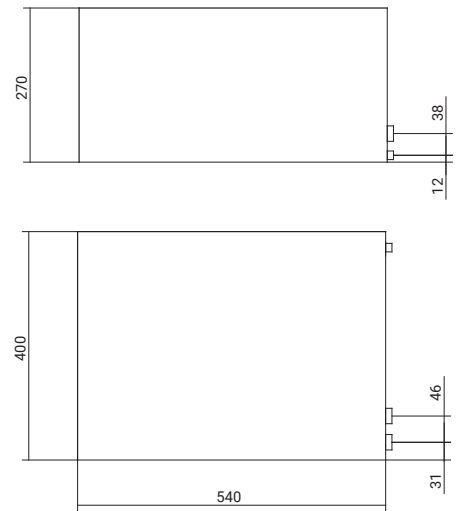

Features	UoM	BIT25BX0B	BIT25CX0B
Cooling capacity - W10A35	W	2500	2500
Water flow rate	l/h	500	500
Power supply	V ~ Hz	230 1~ 50-60	115 1~ 50-60
Width - Height - Depth	mm	400 - 270 - 540	400 - 270 - 540
Max current	A	0.30	0.62
T Fuse	A	2	2
Power draw - W10A35	W	65	67
Electrical connection	-	Cable L = 3 m	Cable L = 3 m
Max liquid circuit pressure	bar	10	10
Water connection	-	1/2" G	1/2" G
Air flow rate	m³/h	750	750
Internal temperature range	°C	20-60	20-60
External temperature range	°C	1-70	1-70
IP rating EN60529	-	IP55	IP55
Noise level	dB (A)	58	58
Weight	kg	19	19
Conformity	-	CE	CE
Pressure drops	Bar	0.3	0.3

BLU10

Air-water heat exchangers for door or wall installation

COOLING CAPACITY

1000 W

PERFORMANCE

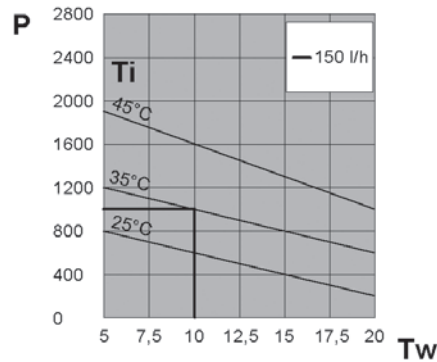

- P = Cooling capacity (W)
- Tw = Water inlet temperature (°C)
- Ti = Internal cabinet temperature (°C)

DIMENSIONS

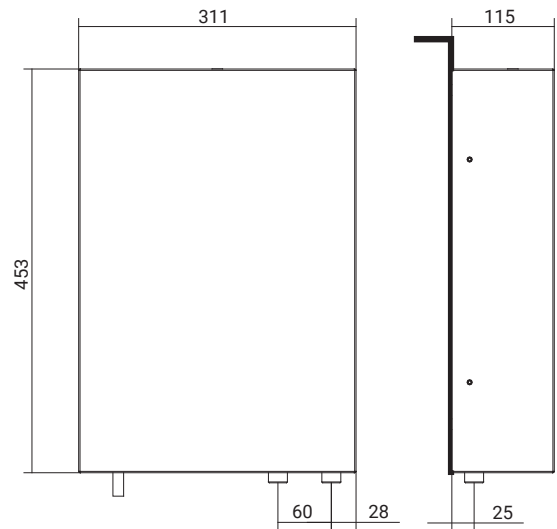

Features	UoM	BLU10BXUB	BLU10CX0B
Cooling capacity - W10A35	W	1000	1000
Water flow rate	l/h	150	150
Power supply	V ~ Hz	230 1~ 50-60	115 1~ 50-60
Width - Height - Depth	mm	311 - 453 - 115	311 - 453 - 115
Max current	A	0.20	0.38
T Fuse	A	2	2
Power draw - W10A35	W	34	25
Electrical connection	-	Cable L = 3 m	Cable L = 3 m
Max liquid circuit pressure	bar	10	10
Water connection	-	3/8" G	3/8" G
Air flow rate	m³/h	330	330
Internal temperature range	°C	20-60	20-60
External temperature range	°C	1-60	1-70
IP rating EN60529	-	IP55	IP55
Noise level	dB (A)	55	55
Weight	kg	12	12
Conformity	-	CE c RU us	CE
Pressure drops	Bar	0.1	0.1

BLU18

Air-water heat exchangers for door or wall installation

COOLING CAPACITY

1750 W



PERFORMANCE

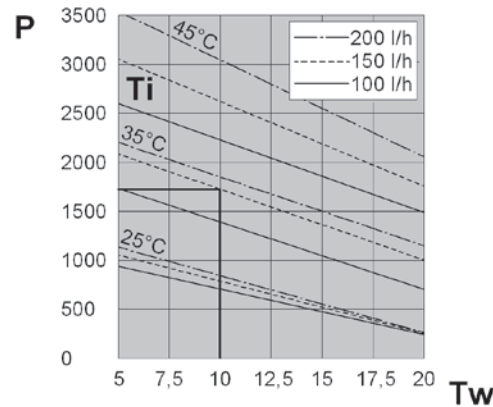

- P = Cooling capacity (W)
- Tw = Water inlet temperature (°C)
- Ti = Internal cabinet temperature (°C)

DIMENSIONS

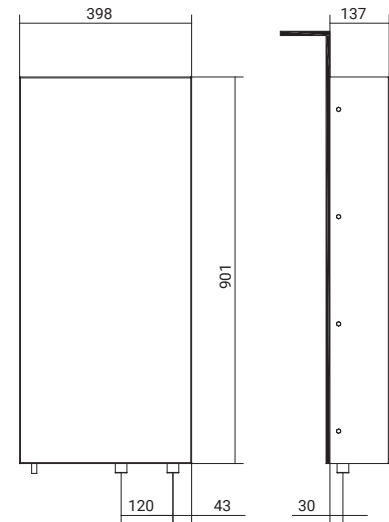

Features	UoM	BLU18BXUB	BLU18CX0B
Cooling capacity - W10A35	W	1750	1750
Water flow rate	l/h	150	150
Power supply	V ~ Hz	230 1~ 50-60	115 1~ 50-60
Width - Height - Depth	mm	398 - 901 - 137	398 - 901 - 137
Max current	A	0.30	0.76
T Fuse	A	2	2
Power draw - W10A35	W	60	77
Electrical connection	-	Cable L = 3 m	Cable L = 3 m
Max liquid circuit pressure	bar	10	10
Water connection	-	1/2" G	1/2" G
Air flow rate	m³/h	570	570
Internal temperature range	°C	20-60	20-60
External temperature range	°C	1-60	1-70
IP rating EN60529	-	IP55	IP55
Noise level	dB (A)	58	58
Weight	kg	18	18
Conformity	-		
Pressure drops	Bar	0.1	0.1

BLU25

Air-water heat exchangers for door or wall installation

COOLING CAPACITY

2500 W

PERFORMANCE

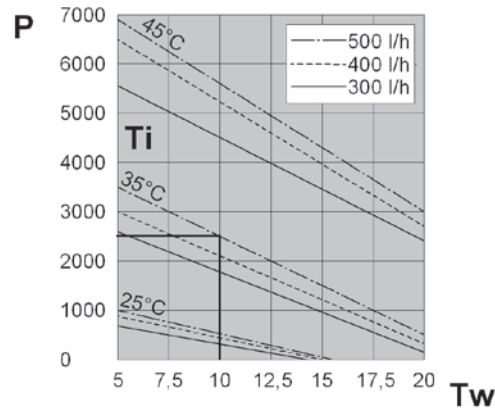

- P = Cooling capacity (W)
- Tw = Water inlet temperature (°C)
- Ti = Internal cabinet temperature (°C)

DIMENSIONS

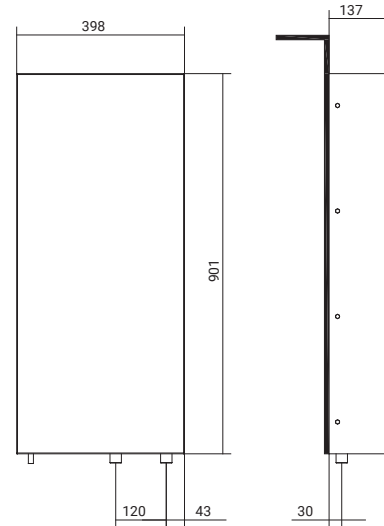

Features	UoM	BLU25BXUB	BLU25CX0B
Cooling capacity - W10A35	W	2500	2500
Water flow rate	l/h	500	500
Power supply	V ~ Hz	230 1~ 50-60	115 1~ 50-60
Width - Height - Depth	mm	398 - 901 - 137	398 - 901 - 137
Max current	A	0.60	0.74
T Fuse	A	2	2
Power draw - W10A35	W	100	82
Electrical connection		Cable L = 3 m	Cable L = 3 m
Max liquid circuit pressure	bar	10	10
Water connection	-	1/2" G	1/2" G
Air flow rate	m³/h	860	860
Internal temperature range	°C	20-60	20-60
External temperature range	°C	1-60	1-70
IP rating EN60529	-	IP55	IP55
Noise level	dB (A)	58	58
Weight	kg	19	19
Conformity	-	CE c RU us	CE
Pressure drops	Bar	0.3	0.3

BLU35

Air-water heat exchangers for door or wall installation

COOLING CAPACITY

3500 W



PERFORMANCE

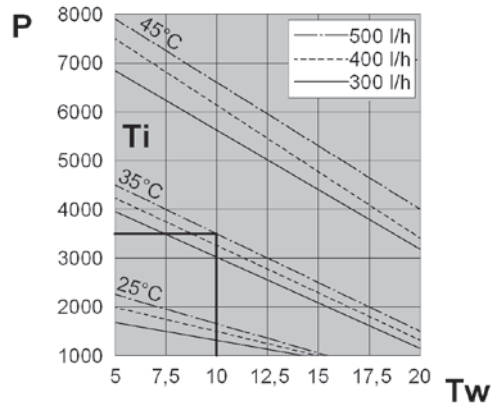

- P = Cooling capacity (W)
- Tw = Water inlet temperature (°C)
- Ti = Internal cabinet temperature (°C)

DIMENSIONS

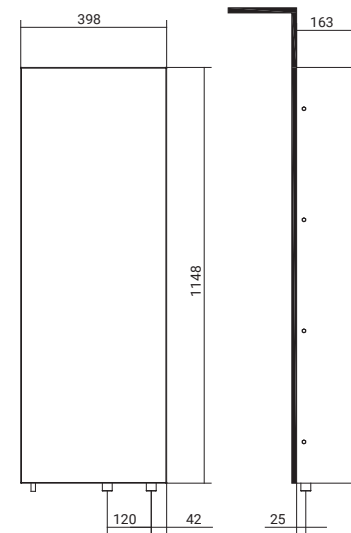

Features	UoM	BLU35BXUB	BLU35CX0B
Cooling capacity - W10A35	W	3500	3500
Water flow rate	l/h	500	500
Power supply	V ~ Hz	230 1~ 50-60	115 1~ 50-60
Width - Height - Depth	mm	398 - 1148 - 163	398 - 1148 - 163
Max current	A	0.80	1.12
T Fuse	A	2	2
Power draw - W10A35	W	140	135
Electrical connection	-	Cable L = 3 m	Cable L = 3 m
Max liquid circuit pressure	bar	10	10
Water connection	-	1/2" G	1/2" G
Air flow rate	m³/h	1050	1050
Internal temperature range	°C	20-60	20-60
External temperature range	°C	1-60	1-70
IP rating EN60529	-	IP55	IP55
Noise level	dB (A)	64	64
Weight	kg	29	29
Conformity	-		
Pressure drops	Bar	0.2	0.2

BLU45

Air-water heat exchangers for door or wall installation

COOLING CAPACITY

4500 W

PERFORMANCE

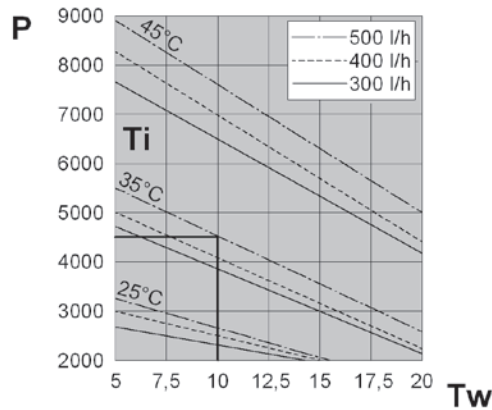

- P = Cooling capacity (W)
- Tw = Water inlet temperature (°C)
- Ti = Internal cabinet temperature (°C)

DIMENSIONS

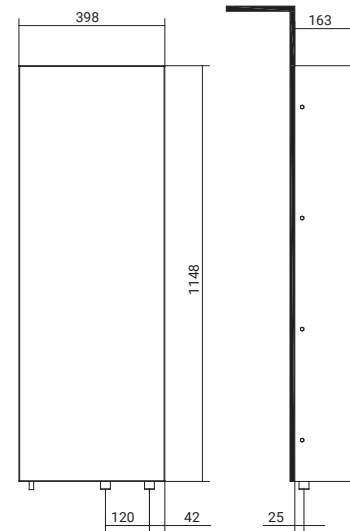

Features	UoM	BLU45BXUB	BLU45CX0B
Cooling capacity - W10A35	W	4500	4500
Water flow rate	l/h	500	500
Power supply	V ~ Hz	230 1~ 50-60	115 1~ 50-60
Width - Height - Depth	mm	398 - 1148 - 163	398 - 1148 - 163
Max current	A	1.20	1.50
T Fuse	A	4	4
Power draw - W10A35	W	220	170
Electrical connection	-	Cable L = 3 m	Cable L = 3 m
Max liquid circuit pressure	bar	10	10
Water connection	-	1/2" G	1/2" G
Air flow rate	m³/h	1450	1450
Internal temperature range	°C	20-60	20-60
External temperature range	°C	1-60	1-70
IP rating EN60529	-	IP55	IP55
Noise level	dB (A)	69	69
Weight	kg	30	30
Conformity	-	CE c RU us	CE
Pressure drops	Bar	0.2	0.2

BLU60

Air-water heat exchangers for door or wall installation

COOLING CAPACITY

6000 W



PERFORMANCE

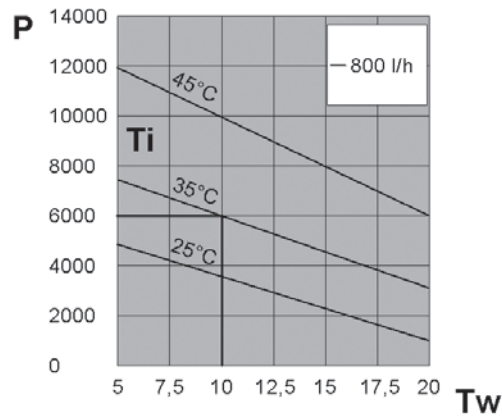

- P = Cooling capacity (W)
- Tw = Water inlet temperature (°C)
- Ti = Internal cabinet temperature (°C)

DIMENSIONS

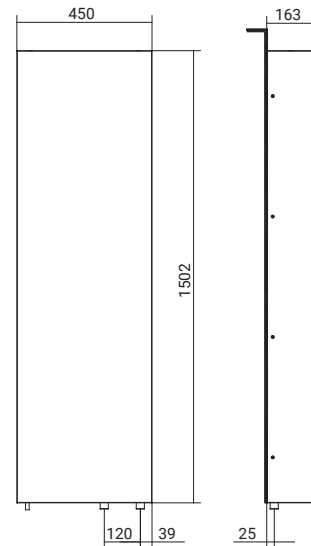

Features	UoM	BLU60BXUB	BLU60CX0B	BLU60GX0B
Cooling capacity - W10A35	W	6000	6000	6000
Water flow rate	l/h	800	800	800
Power supply	V ~ Hz	230 1~ 50-60	115 1~ 50-60	400/440 2~ 50-60
Width - Height - Depth	mm	450 - 1502 - 163	450 - 1502 - 163	450 - 1502 - 163
Max current	A	1.20	1.50	0.40
T Fuse	A	4	4	1
Power draw - W10A35	W	220	170	170
Electrical connection	-	Cable L = 3 m	Cable L = 3 m	Cable L = 3 m
Max liquid circuit pressure	bar	10	10	10
Water connection	m ³ /h	1/2" G	1/2" G	1/2" G
Air flow rate	-	1450	1450	1450
Internal temperature range	°C	20-60	20-60	20-60
External temperature range	°C	1-60	1-70	1-70
EN60529 ingress protection - cabinet side	-	IP55	IP55	IP55
Noise level	dB (A)	69	69	69
Weight	kg	40	40	42
Conformity	-			
Pressure drops	Bar	0.5	0.5	0.5

BLUA0

Air-water heat exchangers for door or wall installation

COOLING CAPACITY

10000 W

PERFORMANCE

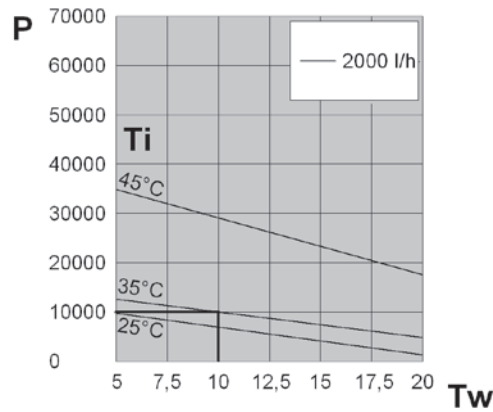

- P = Cooling capacity (W)
- Tw = Water inlet temperature (°C)
- Ti = Internal cabinet temperature (°C)

DIMENSIONS

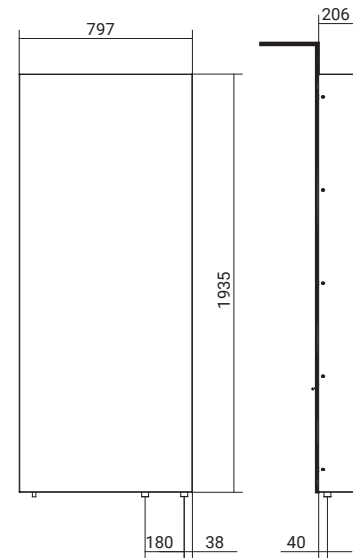

Features	UoM	BLUA0BX0B	BLUA0GX0B
Cooling capacity - W10A35	W	10000	10000
Water flow rate	l/h	2000	2000
Power supply	V ~ Hz	230 1~ 50-60	400/440 2~ 50-60
Width - Height - Depth	mm	797 - 1935 - 206	797 - 1935 - 206
Max current	A	1.90	1.10
T Fuse	A	4	2
Power draw - W10A35	W	420	440
Electrical connection	-	Cable L = 3 m	Cable L = 3 m
Max liquid circuit pressure	bar	10	10
Water connection	-	3/4" G	3/4" G
Air flow rate	m³/h	2900	2900
Internal temperature range	°C	20-60	20-60
External temperature range	°C	1-70	1-70
IP rating EN60529	-	IP55	IP55
Noise level	dB (A)	70	70
Weight	kg	90	90
Conformity	-	CE	CE
Pressure drops	Bar	1.5	1.5

BLUA5

Air-water heat exchangers for door or wall installation

COOLING CAPACITY

15000 W

PERFORMANCE

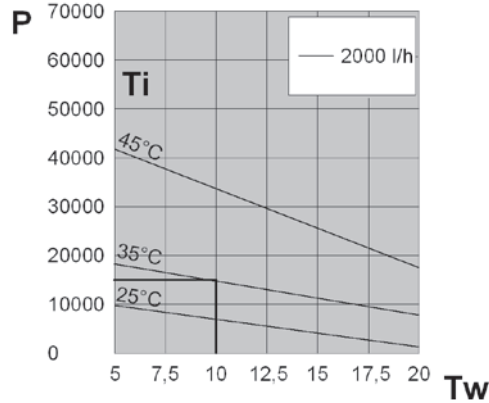

- P = Cooling capacity (W)
- Tw = Water inlet temperature (°C)
- Ti = Internal cabinet temperature (°C)

DIMENSIONS

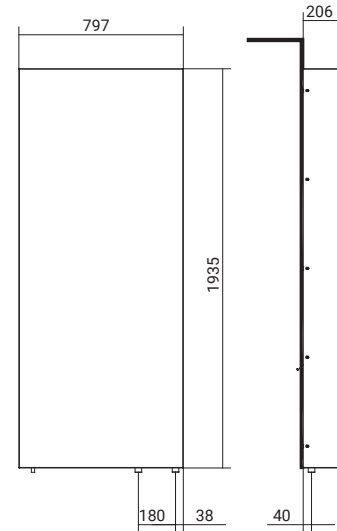

Features	UoM	BLUA5BX0B	BLUA5GX0B
Cooling capacity - W10A35	W	15000	15000
Water capacity	l/h	2000	2000
Power supply	V ~ Hz	230 1~ 50-60	400/440 2~ 50-60
Width - Height - Depth	mm	797 - 1935 - 206	797 - 1935 - 206
Max current	A	1.40	0.90
T Fuse	A	4	2
Power draw - W10A35	W	320	340
Operating cycle	-	100%	100%
Electrical connection	-	Cable L = 3 m	Cable L = 3 m
Type of Refrigerant	-	Water	Water
Max liquid circuit pressure	bar	10	10
Water connection	-	3/4" G	3/4" G
Air flow rate	m³/h	2900	2900
Internal temperature range	°C	20-60	20-60
External temperature range	°C	1-70	1-70
IP rating EN60529	-	IP55	IP55
Noise level	dB (A)	72	70
Weight	kg	92	92
Conformity	-	CE	CE
Pressure drops	Bar	1.8	1.8

BLUB5

Air-water heat exchangers for door or wall installation

COOLING CAPACITY

25000 W



PERFORMANCE

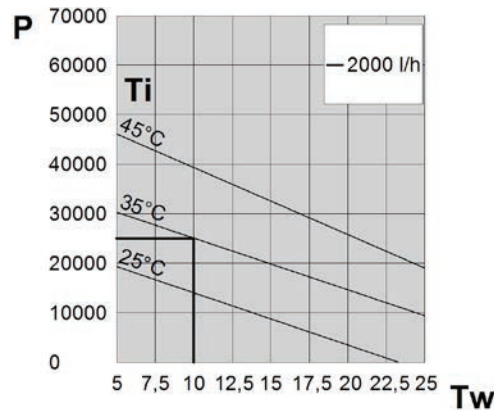

- P = Cooling capacity (W)
- Tw = Water inlet temperature (°C)
- Ti = Internal cabinet temperature (°C)

DIMENSIONS

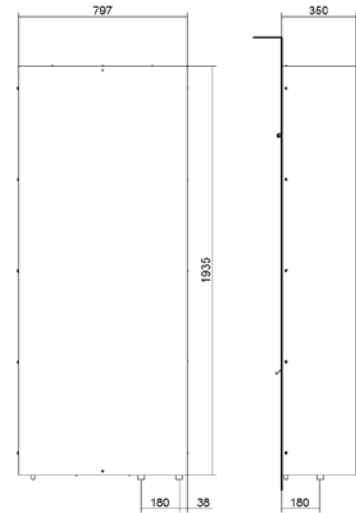

Features	UoM	BLUB5BX0B	BLUB5KX0B
Cooling capacity - W10A35	W	25000	25000
Water flow rate	l/h	2000	2000
Power supply	V ~ Hz	230 1~ 50-60	400/460 2~ 50-60
Width - Height - Depth	mm	797 - 1935 - 350	797- 1935 - 350
Max current	A	2.20	1.30
T Fuse	A	4	2
Power draw - W10A35	W	500	530
Operating cycle	-	100%	100%
Electrical connection	-	Cable L = 3 m	Cable L = 3 m
Type of Refrigerant	-	Water	Water
Max liquid circuit pressure	bar	10	10
Water connection	-	3/4" G	3/4" G
Air flow rate	m³/h	5200	5200
Internal temperature range	°C	20-60	20-60
External temperature range	°C	1-70	1-70
IP rating EN60529	-	IP55	IP55
Noise level	dB (A)	75	75
Weight	kg	120	120
Conformity	-	CE	CE
Pressure drops	Bar	2.0	2.0

MIX

Air-air heat exchangers

High heat exchange efficiency and compact size. The MIX range is the most cost-effective solution for cooling cabinets in favourable ambient conditions.

Wide Range of Specific Power Outputs

The specific thermal power outputs range from 22 to 80 W/K.

Flexibility and Speed of Installation

All heat exchangers in the MIX range can be installed both inside and outside the cabinet as both a rear exit and a side exit for electrical connections is provided for.

Fast, Reduced Maintenance

MIX heat exchangers are equipped with heat exchange coils which prevent clogging by solid contaminants present in the air and which maintain high thermal exchange efficiency even in demanding environmental conditions, minimising maintenance requirements. The remaining maintenance required has been designed to allow easy removal both of the fans and the heat exchanger coil to ensure quick and safe operations.

Maximum Heat Removal

Air intake from the upper part of the cabinet, countercurrent flows and high-efficiency heat exchanger surfaces determine the most rational implementation for these products which result in the removal of the maximum amount of heat.



MIX22

Air-air heat exchangers

SPECIFIC COOLING POWER

22 W/K

PERFORMANCE

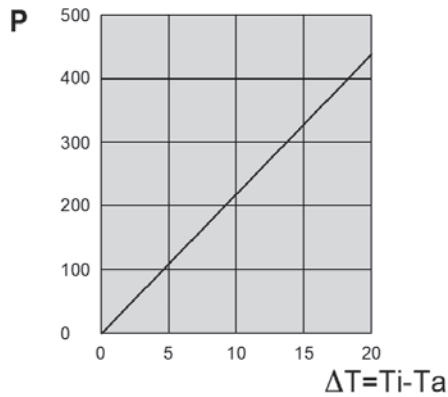

■ P = Cooling capacity (W)

■ ΔT = Temperature differential (Tint-Tamb) (K)

DIMENSIONS

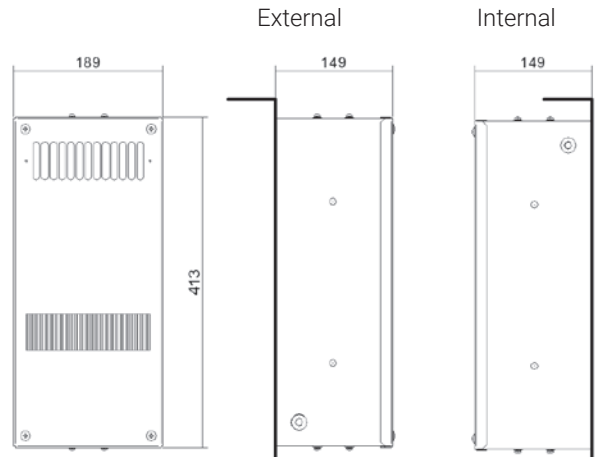

Features	UoM	MIX22BX0B	MIX22CX0B
Specific cooling power	W/K	22	22
Power supply	V ~ Hz	230 1~ 50-60	115 1~ 50-60
Width - Height - Depth	mm	189 - 413 - 149	189 - 413 - 149
Max current	A	0.5	0.96
T Fuse	A	1	2
Power draw	W	72	80
Operating cycle	-	100%	100%
Electrical connection	-	Cable L = 3 m	Cable L = 3 m
External air fan capacity	m³/h	280	280
Cabinet air fan capacity	m³/h	280	280
Temperature limits	°C	-5+55	-5+55
EN60529 ingress protection - cabinet side	-	IP54	IP54
Noise level	dB (A)	59	60
Weight	kg	7	7
Conformity	-	CE	CE

MIX36

Air-air heat exchangers

SPECIFIC COOLING POWER

36 W/K

PERFORMANCE

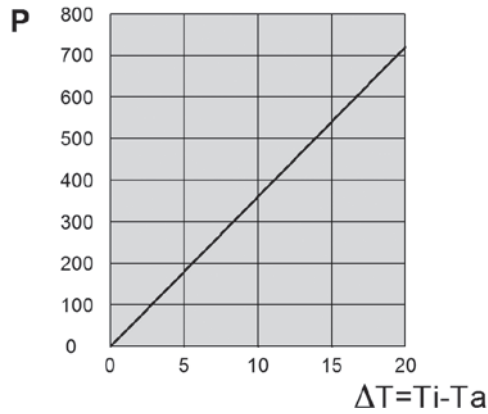

- P = Cooling capacity (W)
- ΔT = Temperature differential (Tint-Tamb) (K)

DIMENSIONS

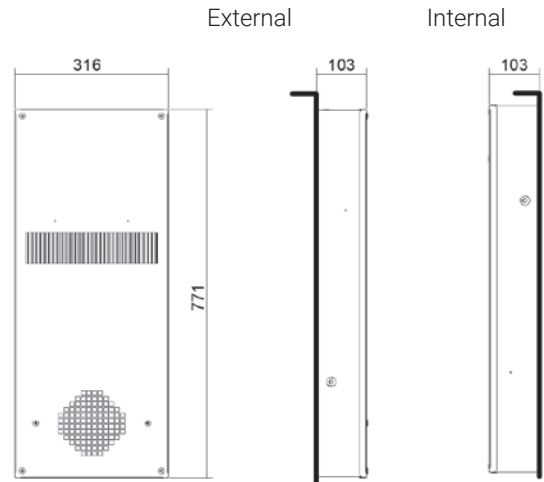

Features	UoM	MIX36BX0B	MIX36CX0B
Specific cooling power	W/K	36	36
Power supply	V ~ Hz	230 1~ 50-60	115 1~ 50-60
Width - Height - Depth	mm	316 - 771 - 103	316 - 771 - 103
Max current	A	0.64	1.12
T Fuse	A	1	2
Power draw	W	160	150
Operating cycle	-	100%	100%
Electrical connection	-	Cable L = 3 m	Cable L = 3 m
External air fan capacity	m³/h	570	570
Cabinet air fan capacity	m³/h	570	570
Temperature limits	°C	-5+55	-5+55
EN60529 ingress protection - cabinet side	-	IP54	IP54
Noise level	dB (A)	67	67
Weight	kg	10	10
Conformity	-	CE	CE

MIX50

Air-air heat exchangers

SPECIFIC COOLING POWER

50 W/K

PERFORMANCE

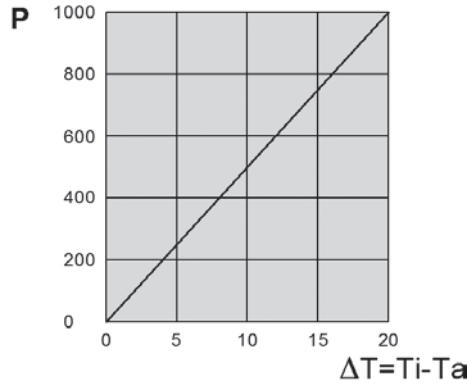

■ P = Cooling capacity (W)

■ ΔT = Temperature differential (Tint-Tamb) (K)

DIMENSIONS



External

Internal



Features	UoM	MIX50BX0B	MIX50CX0B
Specific cooling power	W/K	50	50
Power supply	V ~ Hz	230 1~ 50-60	115 1~ 50-60
Width - Height - Depth	mm	316 - 771 - 103	316 - 771 - 103
Max current	A	0.64	1.12
T Fuse	A	1	2
Power draw	W	160	150
Operating cycle	-	100%	100%
Electrical connection	-	Cable L = 3 m	Cable L = 3 m
External air fan capacity	m³/h	600	600
Cabinet air fan capacity	m³/h	600	600
Temperature limits	°C	-5+55	-5+55
EN60529 ingress protection - cabinet side	-	IP54	IP54
Noise level	dB (A)	67	67
Weight	kg	10	10
Conformity	-	CE	CE

MIX80

Air-air heat exchangers

SPECIFIC COOLING POWER

80 W/K

PERFORMANCE

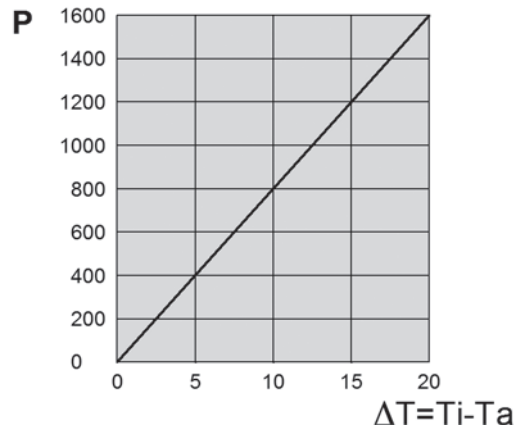

- P = Cooling capacity (W)
- ΔT = Temperature differential ($T_{int} - T_{amb}$) (K)

DIMENSIONS

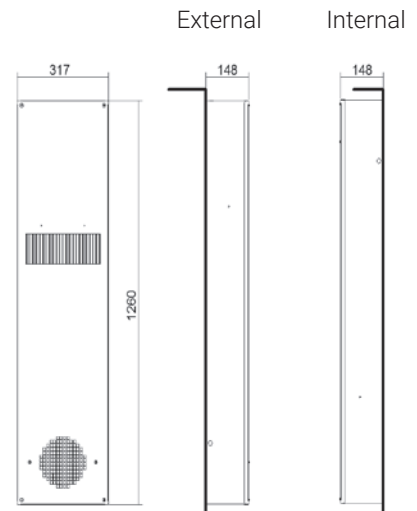

Features	UoM	MIX80BX0B	MIX80CX0B
Specific cooling power	W/K	80	80
Power supply	V ~ Hz	230 1~ 50-60	115 1~ 50-60
Width - Height - Depth	mm	317 - 1260 - 148	317 - 1260 - 148
Max current	A	1.06	2.1
T Fuse	A	2	4
Power draw	W	240	255
Operating cycle	-	100%	100%
Electrical connection	-	Cable L = 3 m	Cable L = 3 m
External air fan capacity	m³/h	1050	1050
Cabinet air fan capacity	m³/h	1050	1050
Temperature limits	°C	-5+55	-5+55
EN60529 ingress protection - cabinet side	-	IP54	IP54
Noise level	dB (A)	75	75
Weight	kg	17	17
Conformity	-	CE	CE



Refrigeration Range

High-precision and high-energy efficiency industrial chillers.





At the Heart of Technology

There are numerous reasons to choose a nVent cooling system

An attention to detail, a huge range of optional accessories and impressive reliability are the key characteristics which set nVent industrial chillers apart.

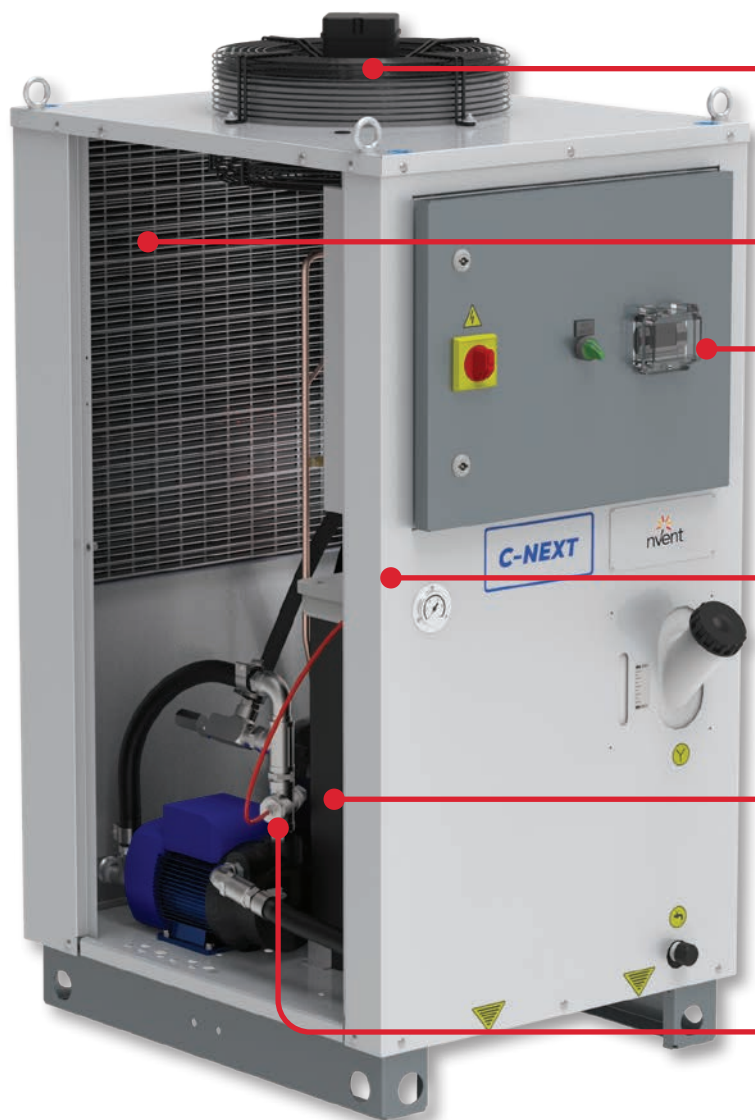

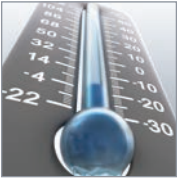

OUTDOOR KIT

All chillers of the C-NEXT range can be provided for installation outdoors with operating limits of -5°C or -20°C .



NEGATIVE COLD

Where temperatures of the cooling medium of as low as -5°C are required, we offer a specific range of chillers borne from our experience in the food and industrial sectors.



EC FANS

The entire C-NEXT range can be provided with electronically commutated EC fans that ensure extremely high performance levels and low energy use.



MICROCHANNEL CONDENSERS

The C-NEXT range was developed with the use of all-aluminium microchannel condensers, a technology that maximises efficiency and reduces the amount of refrigerant.



FLEXIBILITY

The C-NEXT range is designed for over 40 configuration options, whether UL-certified electrical cabinet or stainless steel framework. We ensure customers maximum flexibility and customisation capabilities for the required solution.



SIMPLE AND COMPACT LAYOUT

The C-NEXT range has been designed with a small footprint. By utilizing vertical space, it leaves customers more space for their application.



COOLING PRECISION

Our experience in high-precision applications has led us to develop two kits, mainly created for laser applications, where a precision of $\pm 1^{\circ}\text{C}$ or $\pm 0.5^{\circ}\text{C}$ can be achieved.



NON-FERROUS LIQUID CIRCUIT (STAINLESS STEEL AND BRASS)

All the liquid circuits of our industrial chillers are equipped as standard with pumps, unions and collection tanks in materials not subject to corrosion, primarily stainless steel and brass. This allows us to guarantee the maximum cleanliness and protection of your cooling circuits.

TCW - TAL

Industrial water chillers

TCW-TAL water chillers provide precision and reliability in a compact and modular design. With outputs from 800 W up to 140 kW. The large range of accessories allows multiple chiller configurations.



TCW08÷19 Minichiller

Industrial water chillers

COOLING CAPACITY

900-1100 - 1600-1900 - 2200-2550 W



STRUCTURE

In powder-coated steel sheet, RAL 7035 textured finish. Easily removed panel

COMPRESSOR

Hermetic reciprocating compressor, cooled by the refrigerant, complete with thermal cut-out.

REFRIGERATION CIRCUIT

Complete with charging port, drier filter, expansion valve, high- and low-pressure safety pressure switch, R134a refrigerant.

EVAPORATOR

Brazed stainless-steel plate model.

AIR CONDENSER

Finned high-efficiency copper tube condensing coil, complete with safety grille.

AXIAL FAN

Axial fan, complete with electrical protection and safety grille.

LIQUID CIRCUIT

Liquid circuit composed entirely of non-ferrous material in contact with the liquid to prevent contamination. Standard liquid circuit with open reservoir and pump, protective flow switch, pressure gauge, regulation sensor. Peripheral electric pump with 4.5 bar available head. Plastic storage tank complete with drain valve and visual level indicator.

ELECTRICAL PANEL

With main breaker, fused motor protection with LED visual fault indicator, voltage presence light.

MANAGEMENT AND CONTROL

The TX110 control unit manages the chiller's operation, providing warnings including high/low temperature alarms and a general serious fault alarm, with the display indicating if this refers to the refrigeration or liquid circuit. An on-off contact allows the machine to be switched on remotely. Control disconnect switch for switching on the machine.

PAINT/COATING

Standard colour: RAL 7035 textured.

MAIN OPTIONS

BA - Mechanical bypass valve protecting the pump

BM - Manual bypass valve protecting the pump

LE - Level indicator

LTA - Operation at low ambient temperatures

FP - Polyurethane air filter

RU - Castors

TD - Differential fluid temperature management (two sensors)

BGC - Hot gas bypass for +/-1 K temperature precision

LS - Liquid circuit for laser application

- HIGH-pressure pump
- Satin AISI 304 stainless steel framework

DIMENSIONS

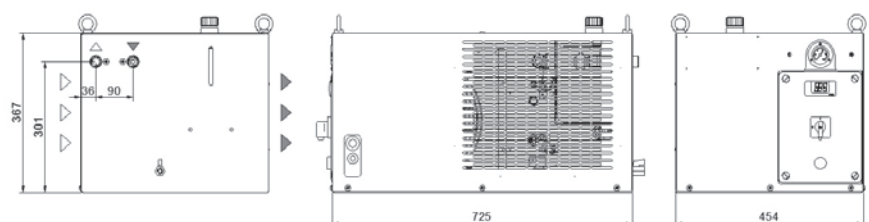



Model		TCW08		TCW12		TCW19	
		50 Hz	60 Hz	50 Hz	60 Hz	50 Hz	60 Hz
Rated Cooling Capacity*	W	900	1100	1600	1900	2200	2550
Ambient temperature operating limits	°C	+15 - +45					
Settable fluid temperature range	°C	+8 - +25					
Fluid type		Water					
Temperature precision	K	+/-2					
Refrigerant gas	HFC	R134a					
Power supply							
Supply voltage	V ph Hz	230 V (+/-10%) 1ph 50/60 Hz					
Secondary supply voltage	V	230					
Digital thermostat		TX110					
Compressor							
Compressor type		Reciprocating					
Quantity - Number of circuits	no.	1 - 1					
Axial Fan							
Fan type		Axial					
Quantity	no.	1		1		1	
Air flow rate	m³/h	1000		1000		1000	
Max. power draw	W	150	190	150	190	150	190
Standard Pump							
Pump type		Peripheral					
Nominal/max fluid flow rate	l/min	3.0 - 20.0		5.0 - 20.0		6.5 - 20.0	
Nominal available head	bar	5.4	7.6	4.6	6.7	4	6
High-Pressure Pump (optional)							
Pump type		Peripheral					
Quantity	no.	1		1		1	
Nominal available head	bar	6.5	8.4	6	7.9	5.8	7.6
Storage tank capacity							
Storage tank capacity	l	10					
IN/OUT liquid connections	mm	1/2"					
Net weight	kg	52		54		55	
Width - Depth - Height	mm	725 - 454 - 367					
Sound pressure level**	dB (A)	56		56		56	

* Data relating to operation under the following conditions: intake/outlet temperature 20/15°C, water without glycol, ambient temperature 32°C. Cooling power refers to the evaporator unit.

** Sound pressure level at 50 Hz, measured in a free hemispherical field at a distance of 1 m from the machine and 1.5 metres from the ground, per ISO 3746.

Correction factors for calculating the cooling power													
Water outlet temperature	Fw	°C					8	10	15	20	25		
		factor					0.86	0.92	1	1.05	1.12		
Ambient Temperature	Fa	°C					15	20	25	32	35	40	45
		factor					1.16	1.1	1.05	1	0.97	0.91	0.84
Percentage glycol by weight	Fg	%	0	10	15	20	25	30	35	40			
		factor	1	0.99	0.98	0.97	0.96	0.94	0.92	0.89			
Cooling power = Nominal cooling power x Fw x Fa x Fg													

TCW31-41 Minichiller HP

Industrial water chillers

COOLING CAPACITY

3000-3450 - 3900-4450 W



STRUCTURE

In powder-coated steel sheet, RAL 7035 textured finish. Easily removed panel

COMPRESSOR

Hermetic reciprocating compressor, cooled by the refrigerant, complete with thermal cut-out.

REFRIGERATION CIRCUIT

Complete with charging port, drier filter, expansion valve, high- and low-pressure safety pressure switch, thermostatic valve.

R134a refrigerant.

EVAPORATOR

Brazed stainless-steel plate model.

AIR CONDENSER

Finned high-efficiency copper tube condensing coil, complete with safety grille.

AXIAL FAN

Axial fan, complete with electrical thermal protection and safety grille.

LIQUID CIRCUIT

Liquid circuit composed entirely of non-ferrous material in contact with the liquid to prevent contamination. Standard liquid circuit with open reservoir and pump, protective flow switch, pressure gauge, regulation sensor. Peripheral electric pump with 4.5 bar available head. Plastic storage tank complete with drain valve and visual level indicator.

ELECTRICAL PANEL

With main breaker, fused motor protection with LED visual fault indicator, voltage presence light.

MANAGEMENT AND CONTROL

The TX110 control unit manages the chiller's operation, providing warnings including high/low temperature alarms and a general serious fault alarm, with the display indicating if this refers to the refrigeration or liquid circuit. An on-off contact allows the machine to be switched on remotely. Control disconnect switch for switching on the machine.

PAINT/COATING

Standard colour: RAL 7035 textured.

MAIN OPTIONS

BA - Mechanical bypass valve protecting the pump

BM - Manual bypass valve protecting the pump

LE - Electrical level indicator

LTA - Operation at low ambient temperatures

FP - Polyurethane air filter

RU - Castors

TD - Differential fluid temperature management (two sensors)

BGC - Hot gas bypass for +/-1 K temperature precision

- HIGH-pressure pump
- Non-standard paint/coating
- Satin AISI 304 stainless steel framework

DIMENSIONS

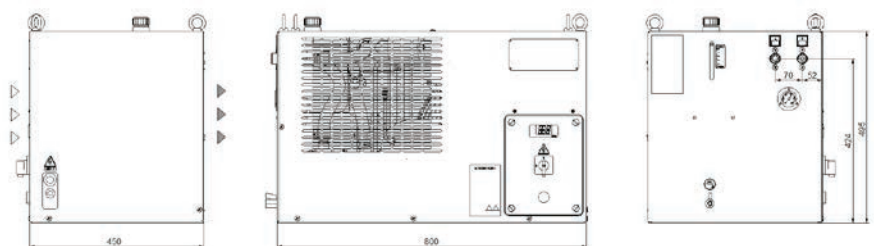



Model		TCW31		TCW41	
		50 Hz	60 Hz	50 Hz	60 Hz
Rated Cooling Capacity*	W	3000	3450	3900	4450
Ambient temperature operating limits	°C	+15 - +45			
Settable fluid temperature range	°C	+8 - +25			
Fluid type		Water			
Temperature precision	K	+/-2			
Refrigerant gas	HFC	R134a			
Power supply					
Supply voltage	V ph Hz	230 V (+/-10%) 1ph 50/60 Hz			
Secondary supply voltage	V	230			
Digital thermostat		TX110			
Compressor					
Compressor type		Reciprocating			
Quantity - Number of circuits	no.	1 - 1			
Max. power draw	kW	1.15	1.5	1.6	1.92
Max. current draw	A	6.1	8.1	7.2	8.4
Axial Fan					
Compressor type		Axial			
Quantity	no.	1		1	
Air flow rate	m³/h	2300	2650	2300	2650
Max. power draw	W	180	250	180	250
Max. current draw	A	0.81	1.1	0.81	1.1
Standard Pump					
Pump type		Peripheral			
Quantity	no.	1		1	
Nominal/max fluid flow rate	l/min	6.5 - 20		11 - 20	
Nominal available head	bar	4	6	2.8	4
Available power draw	kW	0.75	0.75	0.75	0.75
Max. current draw	A	2.8	3.7	2.8	3.7
High-Pressure Pump (optional)					
Pump type		Peripheral			
Quantity	no.	1		1	
Nominal available head	bar	5.8	7.6	4.9	6.6
Max. power draw	kW	1.29	1.29	1.29	1.29
Max. current draw	A	5	6	5	6
Storage tank capacity	l	10			
IN/OUT liquid connections	mm	1/2"			
Net weight (approximate)***	kg	74		75	
Width - Depth - Height	mm	800 - 450 - 495			
Sound pressure level**	dB (A)	57	60	57	60
IP rating	IP	44			

* Data relating to operation under the following conditions: intake/outlet temperature 20/15°C, water without glycol, ambient temperature 32°C. Cooling power refers to the evaporator unit.

** Sound pressure level at 50 Hz, measured in a free hemispherical field at a distance of 1 m from the machine and 1.5 metres from the ground, per ISO 3746.

*** Weight includes pallets and packaging (where provided for), with refrigerant charge, storage tank empty, axial fans.

The electrical data refer to cos φ = 0.8.

Correction factors for calculating the cooling power													
Water outlet temperature	Fw	°C					8	10	15	20	25		
		factor					0.86	0.92	1	1.05	1.12		
Ambient Temperature	Fa	°C					15	20	25	32	35	40	45
		factor					1.16	1.1	1.05	1	0.97	0.91	0.84
Percentage glycol by weight	Fg	%	0	10	15	20	25	30	35	40			
		factor	1	0.99	0.98	0.97	0.96	0.94	0.92	0.89			
Cooling power = Nominal cooling power x Fw x Fa x Fg													

C-Next TAL24-37 Size 1

Industrial water chillers

COOLING CAPACITY

2300-2700 - 3600-4200 W



STRUCTURE

In powder-coated steel sheet, RAL 7035 textured finish. Easily removed panels

COMPRESSOR

Hermetic reciprocating compressor, cooled by the refrigerant, complete with thermal cut-out.

REFRIGERATION CIRCUIT

Complete with charging port, drier filter, expansion valve, high-pressure pressure switch, R134a refrigerant.

EVAPORATOR

Brazed stainless-steel plate model.

AIR CONDENSER

Microchannel condensing coil, complete with safety grille.

AXIAL FAN

Axial fan, complete with thermal cut-out and safety grille.

LIQUID CIRCUIT

Non-ferrous liquid circuit composed of peripheral electric pump, storage tank made of plastic material complete with integrated visual level indicator, 0–10 bar pressure gauge, protective flow switch, regulation sensor.

ELECTRICAL PANEL

With main disconnect switch, fused motor protection.

MANAGEMENT AND CONTROL

The TX110 control unit manages the chiller's operation, providing warnings including high/low temperature alarms and a general serious fault alarm, with the display indicating if this refers to the refrigeration or liquid circuit. An on-off contact allows the machine to be switched on remotely (pump included). Control disconnect switch for switching on the machine.

PAINT/COATING

Standard colour: RAL 7035 textured.

MAIN OPTIONS

BA - Mechanical bypass valve protecting the pump

LTA - Operation at low ambient temperatures

FP - Polyurethane air filter

RU - Castors

TD - Differential fluid temperature management (two sensors)

BGC - Hot gas bypass for +/-1 K temperature precision

BGP - Hot gas bypass for +/-0.5 K temperature precision

LS - Liquid circuit for laser application

UL1 - Electrical panel and UL-certified components

LTW - Water temperature range -10/+5°C

- HIGH-pressure pump version "H" - 5 bar, version "R" - 7 bar.
- Outdoor installation options

DIMENSIONS

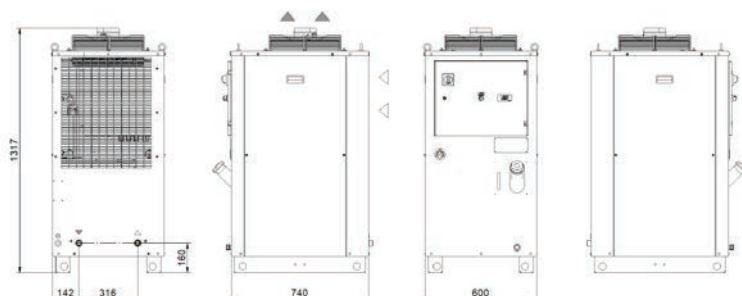



Model		TAL24		TAL37	
		50 Hz	60 Hz	50 Hz	60 Hz
Rated Cooling Capacity*	W	2300	2700	3600	4200
Ambient temperature operating limits	°C	+15 - +45			
Settable fluid temperature range	°C	+8 - +25			
Fluid type	-	Water			
Temperature precision	K	+/-2			
Refrigerant gas	HFC	R134a			
Power supply					
Supply voltage	V ph Hz	230 V (+/-10%) 1ph 50/60 Hz			
Secondary supply voltage	V	230 V AC			
Digital thermostat		TX110			
Compressor					
Compressor type		Reciprocating			
Quantity - Number of circuits	no.	1 - 1			
Nominal power draw	kW	0.84	1.04	1.16	1.5
Axial Fan					
Fan type		Axial			
Quantity	no.	1			
Air flow rate	m³/h	1250 - 1650		1550 - 2050	
Centrifugal Fan (optional)					
Fan type		Centrifugal			
Quantity	no.	1			
Air flow rate	m³/h	2100 - 2400		2100 - 2400	
Available head	Pa	250			
Standard Pump					
Pump type		Peripheral			
Quantity	no.	1			
Nominal/max fluid flow rate	l/min	7 - 18		10 - 18	
Nominal available head	bar	3.8	5.8	3.1	4.5
High-Pressure Pump (optional)					
Pump type		Peripheral			
Quantity	no.	1			
Nominal available head	bar	5.6	7.5	5	6.8
Storage tank					
Storage tank capacity	l	50			
IN/OUT liquid connections	inch	3/4"			
Net weight (approximate)**	kg	151		153	
Width - Depth - Height	mm	600 - 740 - 1317			
Sound pressure level**	dB (A)	57	60	57	60

* Data relates to operation under the following conditions: inlet/outlet temp. 20/15°C, water without glycol, ambient temperature 32°C.

** Sound pressure level, measured in a free parallelepiped field at a distance of 1 m, per ISO 3746.

*** Weight includes pallets and packaging (where provided for), with refrigerant charge, storage tank empty, axial fans.

The electrical data refer to cos φ = 0.8.

Correction factors for calculating the cooling power													
Water outlet temperature	Fw	°C					8	10	15	20	25		
		factor					0.69	0.77	1	1.22	1.44		
Ambient Temperature	Fa	°C					15	20	25	32	35	40	45
		factor					1.26	1.2	1.11	1	0.95	0.87	0.80
Percentage glycol by weight	Fg	%	0	10	15	20	25	30	35	40			
		factor	1	0.96	0.95	0.94	0.93	0.91	0.90	0.88			
Cooling power = Nominal cooling power x Fw x Fa x Fg													

C-Next TAL29÷A0 Size 1 Three-phase

Industrial water chillers

COOLING CAPACITY

2900 - 3600 - 4550 - 6000 - 8100 - 9550 - 10900 W



STRUCTURE

In powder-coated steel sheet, RAL 7035 textured finish. Easily removed panels

COMPRESSOR

Hermetic Reciprocating or Scroll compressor, cooled by the refrigerant, complete with thermal cut-out.

REFRIGERATION CIRCUIT

Complete with charging port, drier filter, expansion or thermostatic valve, high-pressure pressure switch, R134a refrigerant.

EVAPORATOR

Brazed stainless-steel plate model.

AIR CONDENSER

Microchannel condensing coil, complete with safety grille.

AXIAL FAN

Axial fan, complete with thermal cut-out and safety grille.

LIQUID CIRCUIT

Non-ferrous liquid circuit composed of centrifugal electric pump, storage tank made of plastic material complete with integrated visual level indicator, 0–10 bar pressure gauge, protective flow switch, regulation sensor.

ELECTRICAL PANEL

With main disconnect switch, relay motor protection, phase sequence relays.

MANAGEMENT AND CONTROL

The TX110 control unit manages the chiller's operation, providing warnings including high/low temperature alarms and a general serious fault alarm, with the display indicating if this refers to the refrigeration or liquid circuit. An on-off contact allows the machine to be switched on remotely (pump included). Control disconnect switch for switching on the machine.

PAINT/COATING

Standard colour: RAL 7035 textured.

MAIN OPTIONS

BA - Mechanical bypass valve protecting the pump

LTA - Operation at low ambient temperatures

FP - Polyurethane air filter

RU - Castors

TD - Differential fluid temperature management (two sensors)

BGC - Hot gas bypass for +/-1 K temperature precision

BGP - Hot gas bypass for +/-0.5 K temperature precision

LS - Liquid circuit for laser application

UL1 - Electrical panel and UL-certified components

LTW - Water temperature range -10/+5°C

- HIGH-pressure pump version "H" - 5 bar, version "R" - 7 bar.
- Outdoor installation options

DIMENSIONS

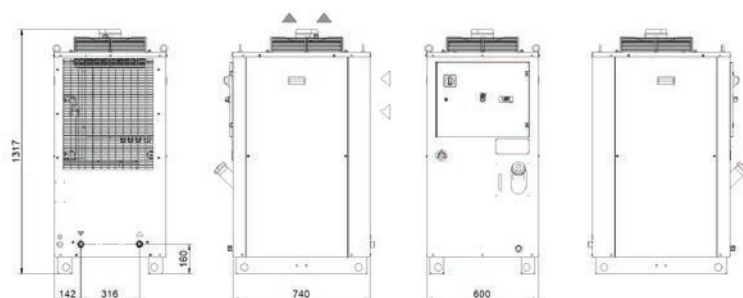



Model		TAL29	TAL37	TAL46	TAL57	TAL76	TAL93	TALAO	
Rated Cooling Capacity*	W	2900	3600	4550	6000	8100	9550	10900	
Ambient temperature operating limits	°C	+15 - +45							
Settable fluid temperature range	°C	+8 - +25							
Fluid type		Water							
Temperature precision	K	+/-2							
Refrigerant gas	HFC	R134a							
Power supply									
Supply voltage	V ph Hz	400 V (+/-10%) 3 ph 50 Hz							
Secondary supply voltage	V	230 V AC							
Digital thermostat		TX110							
Compressor									
Compressor type		Reciprocating				Scroll			
Quantity - Number of circuits	no.	1 - 1							
Nominal power draw	kW	0.78	1.16	1.42	2.42	2.21	2.60	2.73	
Axial Fan									
Fan type		Axial							
Quantity	no.	1							
Air flow rate	m³/h	1550	1550	1800	1800	3150	3350	4400	
Centrifugal Fan (optional)									
Fan type		Centrifugal							
Quantity	no.	1							
Air flow rate	m³/h	2100 - 2400	2100 - 2400	2100 - 2400	2100 - 2400	2100 - 2400	2100 - 2400	2100 - 2400	
Available head	Pa	250							
Standard Pump									
Pump type		Centrifugal							
Quantity	no.	1							
Nominal/max fluid flow rate	l/min	8 - 40	10 - 40	12.5 - 40	16 - 40	21 - 70	26 - 70	31.5 - 70	
Nominal available head	bar	3	2.9	2.8	2.7	3.1	3	2.8	
High-Pressure Pump (optional)									
Pump type		Centrifugal							
Quantity	no.	1							
Nominal available head	bar	5.1	4.9	4.8	4.6	5.5	5.3	5.1	
Storage tank capacity	l	50							
IN/OUT liquid connections	inch	3/4"							
Net weight (approximate)***	kg	151	153	155	160	165	170	175	
Width - Depth - Height	mm	600 - 740 - 1317							
Sound pressure level**	dB (A)	57	57	57	57	57	57	57	

* Data relates to operation under the following conditions: inlet/outlet temp. 20/15°C, water without glycol, ambient temperature 32°C.

** Sound pressure level, measured in a free parallelepiped field at a distance of 1 m, per ISO 3746.

*** Weight includes pallets and packaging (where provided for), with refrigerant charge, storage tank empty, axial fans.

The electrical data refer to cos φ = 0.8.

Correction factors for calculating the cooling power													
Water outlet temperature	Fw	°C					8	10	15	20	25		
		factor					0.69	0.77	1	1.22	1.44		
Ambient Temperature	Fa	°C					15	20	25	32	35	40	45
		factor					1.26	1.2	1.11	1	0.95	0.87	0.80
Percentage glycol by weight	Fg	%	0	10	15	20	25	30	35	40			
		factor	1	0.96	0.95	0.94	0.93	0.91	0.90	0.88			
Cooling power = Nominal cooling power x Fw x Fa x Fg													

C-Next TALA1÷A8 Size 2

Industrial water chillers

COOLING CAPACITY

11400 - 12400 - 17800 - 20100 W



STRUCTURE

In powder-coated steel sheet, RAL 7035 textured finish. Easily removed panels

COMPRESSOR

Hermetic scroll compressor, cooled by the refrigerant, complete with thermal cut-out.

REFRIGERATION CIRCUIT

Complete with charging port, liquid receiver, drier filter, thermostatic valve, high- and low-pressure pressure switch, R410A refrigerant.

EVAPORATOR

Brazed stainless-steel plate model.

AIR CONDENSER

Microchannel condensing coil, complete with safety grille.

AXIAL FAN

Axial fan, complete with thermal cut-out and safety grille.

LIQUID CIRCUIT

Non-ferrous liquid circuit composed of stainless steel centrifugal electric pump, storage tank made of plastic material complete with integrated visual level indicator, electrical level indicator, 0-10 bar pressure gauge, differential pressure switch protecting the water flow, regulation sensor.

ELECTRICAL PANEL

With main disconnect switch, relay motor protection, phase sequence relays.

MANAGEMENT AND CONTROL

The TX200 control unit manages the operation of the chiller and provides complete operator alarm diagnostics. An on-off contact allows the machine to be switched on remotely. Illuminated control selector. Possibility of remote display for machine regulation.

PAINT/COATING

Standard colour: RAL 7035 textured.

MAIN OPTIONS

BA - Mechanical bypass valve protecting the pump

FL - Flow switch with alarm contact

FP - Polyurethane air filter

RU - Castors

TD - Differential fluid temperature management (two sensors)

BGC - Hot gas bypass for +/-1 K temperature precision

LS - Liquid circuit for laser application

HP/HS - Harting-type connector

- HIGH-pressure pump version "H" - 5 bar, version "R" - 7 bar.
- Outdoor installation options

DIMENSIONS

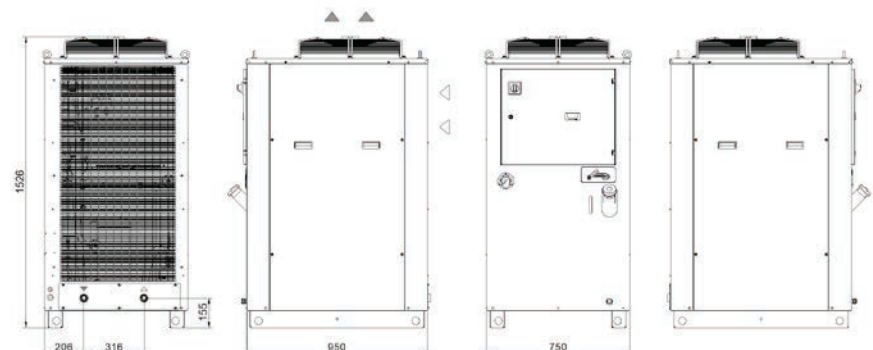



Model		TALA1	TALA3	TALA5	TALA8
Rated Cooling Capacity*	W	11400	12400	17800	20100
Ambient temperature operating limits	°C	+15 - +45			
Settable fluid temperature range	°C	+8 - +25			
Fluid type		Water			
Temperature precision	K	+/-2			
Refrigerant gas	HFC	R410A			
Power supply					
Supply voltage	V ph Hz	400 V (+/-10%) 3 ph 50 Hz			
Secondary supply voltage	V	24 V AC			
Digital thermostat		TX200			
Compressor					
Compressor type		Scroll			
Quantity - Number of circuits	no.	1 - 1			
Nominal power draw	kW	3.03	3.12	4.08	4.91
Axial Fan					
Fan type		Axial			
Quantity	no.	1			
Air flow rate	m³/h	6500	6500	6500	6500
Centrifugal Fan (optional)					
Fan type		Centrifugal			
Quantity	no.	1			
Air flow rate	m³/h	6500	6500	6500	6500
Available head	Pa	250			
Standard Pump					
Pump type		Centrifugal			
Quantity	no.	1			
Nominal/max fluid flow rate	l/min	31 - 70	35 - 70	50 - 70	58 - 70
Nominal available head	bar	3.7	3.5	2.8	2.5
High-Pressure Pump (optional)					
Pump type		Centrifugal			
Quantity	no.	1			
Nominal available head	bar	5.2	5	5	4.2
Storage tank capacity					
Storage tank capacity	l	130			
IN/OUT liquid connections	inch	1"			
Net weight (approximate)***	kg	200	200	235	235
Width - Depth - Height	mm	750 - 950 - 1526			
Sound pressure level**	dB (A)	67	67	67	67

* Data relates to operation under the following conditions: inlet/outlet temp. 20/15°C, water without glycol, ambient temperature 32°C.

** Sound pressure level, measured in a free parallelepiped field at a distance of 1 m, per ISO 3746.

*** Weight includes pallets and packaging (where provided for), with refrigerant charge, storage tank empty, axial fans.

The electrical data refer to cos φ = 0.8.

Correction factors for calculating the cooling power													
Water outlet temperature	Fw	°C					8	10	15	20	25		
		factor					0.76	0.82	1	1.22	1.43		
Ambient Temperature	Fa	°C					15	20	25	32	35	40	45
		factor					1.26	1.2	1.12	1	0.95	0.87	0.80
Percentage glycol by weight	Fg	%	0	10	15	20	25	30	35	40			
		factor	1	0.96	0.95	0.94	0.93	0.91	0.90	0.88			
Cooling power = Nominal cooling power x Fw x Fa x Fg													

C-Next TALB5÷C5 Size 3

Industrial water chillers

COOLING CAPACITY

24800 - 29000 - 35800 W



STRUCTURE

In powder-coated steel sheet, RAL 7035 textured finish. Easily removed panels

COMPRESSOR

Hermetic scroll compressor, cooled by the refrigerant, complete with thermal cut-out.

REFRIGERATION CIRCUIT

Complete with charging port, liquid receiver, drier filter, thermostatic valve, high- and low-pressure pressure switch, R410A refrigerant.

EVAPORATOR

Brazed stainless-steel plate model.

AIR CONDENSER

Microchannel condensing coil, complete with safety grille.

AXIAL FAN

Axial fan, complete with thermal cut-out and safety grille.

LIQUID CIRCUIT

Non-ferrous liquid circuit composed of stainless steel centrifugal electric pump, storage tank made of plastic material complete with integrated visual level indicator, electrical level indicator, 0-10 bar pressure gauge, differential pressure switch protecting the water flow, automatic by-pass and regulation sensor.

ELECTRICAL PANEL

With main disconnect switch, relay motor protection, phase sequence relays.

MANAGEMENT AND CONTROL

The TX200 control unit manages the operation of the chiller and provides complete operator alarm diagnostics. An on-off contact allows the machine to be switched on remotely. Illuminated control selector. Possibility of remote display for machine regulation.

PAINT/COATING

Standard colour: RAL 7035 textured.

MAIN OPTIONS

FL - Flow switch with alarm contact

FP - Polyurethane air filter

RU - Castors

TD - Differential fluid temperature management (two sensors)

BGC - Hot gas bypass for +/-1 K temperature precision

LS - Liquid circuit for laser application

HP/HS - Harting-type connector

- HIGH-pressure pump version "H" - 5 bar, version "R" - 7 bar.
- Outdoor installation options

DIMENSIONS

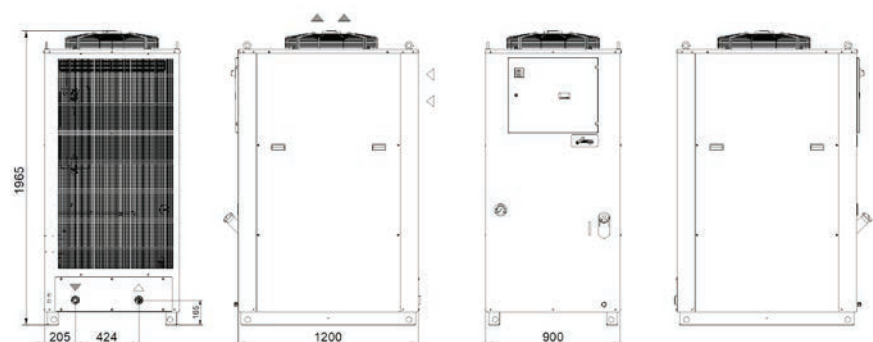



Model		TALB5	TALB9	TALC5
Rated Cooling Capacity*	W	24800	29000	35800
Ambient temperature operating limits	°C	+15 - +45		
Settable fluid temperature range	°C	+8 - +25		
Fluid type		Water		
Temperature precision	K	+/-2		
Refrigerant gas	HFC	R410A		
Power supply				
Supply voltage	V ph Hz	400 V (+/-10%) 3 ph 50 Hz		
Secondary supply voltage	V	24 V AC		
Digital thermostat		TX200		
Compressor				
Compressor type		Scroll		
Quantity - Number of circuits	no.	1 - 1		
Nominal power draw	kW	6.4	7.4	8.6
Axial Fan				
Fan type		Axial		
Quantity	no.	1		
Air flow rate	m³/h	8300	9700	11500
Centrifugal Fan (optional)				
Fan type		Centrifugal		
Quantity	no.	1		
Air flow rate	m³/h	8300	9700	11500
Available head	Pa	370	180	100
Standard Pump				
Pump type		Centrifugal		
Quantity	no.	1		
Nominal/max fluid flow rate	l/min	79 - 150	92 - 150	100 - 150
Nominal available head	bar	3.5	3.2	3.0
High-Pressure Pump (optional)				
Pump type		Centrifugal		
Quantity	no.	1		
Nominal available head	bar	5.4	5.1	4.9
Storage tank capacity				
Storage tank capacity	l	130		
IN/OUT liquid connections	inch	1 1/2"		
Net weight (approximate)***	kg	260	260	260
Width - Depth - Height	mm	900 - 1200 - 1965		
Sound pressure level**	dB (A)	67	67	67

* Data relates to operation under the following conditions: inlet/outlet temp. 20/15°C, water without glycol, ambient temperature 32°C.

** Sound pressure level, measured in a free parallelepiped field at a distance of 1 m, per ISO 3746.

*** Weight includes pallets and packaging (where provided for), with refrigerant charge, storage tank empty, axial fans.

The electrical data refer to cos φ = 0.8.

Correction factors for calculating the cooling power													
Water outlet temperature	Fw	°C					8	10	15	20	25		
		factor					0.79	0.84	1	1.18	1.37		
Ambient Temperature	Fa	°C					15	20	25	32	35	40	45
		factor					1.25	1.2	1.09	1	0.97	0.91	0.87
Percentage glycol by weight	Fg	%	0	10	15	20	25	30	35	40			
		factor	1	0.96	0.95	0.94	0.93	0.91	0.90	0.88			
Cooling power = Nominal cooling power x Fw x Fa x Fg													

C-Next TALD0÷F8 Size 4

Industrial water chillers

COOLING CAPACITY

40000 - 47000 - 55000 - 67000 W



STRUCTURE

In powder-coated steel sheet, RAL 7035 textured finish. Easily removed panels

COMPRESSOR

Hermetic scroll compressor, cooled by the refrigerant, complete with thermal cut-out.

REFRIGERATION CIRCUIT

Complete with charging port, liquid receiver, drier filter, thermostatic valve, high- and low-pressure pressure switch, R410A refrigerant. Optional 2-step cooling power regulation (standard on TALF8).

EVAPORATOR

Brazed stainless-steel plate model.

AIR CONDENSER

Microchannel condensing coil, complete with safety grille.

AXIAL FAN

Axial fan, complete with thermal cut-out and safety grille.

LIQUID CIRCUIT

Non-ferrous liquid circuit composed of stainless steel centrifugal electric pump, storage tank made of plastic material complete with drain valve, electrical level indicator, 0-10 bar pressure gauge, differential pressure switch protecting the water flow, automatic by-pass and regulation sensor.

ELECTRICAL PANEL

With main disconnect switch, relay motor protection, phase sequence relays.

MANAGEMENT AND CONTROL

The TX350C control unit manages the operation of the chiller and provides complete operator alarm diagnostics. An on-off contact allows the machine to be switched on remotely. Illuminated control selector. RS485 connection. Possibility of remote display for machine regulation.

PAINT/COATING

Standard colour: RAL 7035 textured.

MAIN OPTIONS

FL - Flow switch with alarm contact

HR - Fluid heating element

OM - Unit built for outdoor operation down to -10°C ambient temp.

OML - Unit built for outdoor operation down to -20°C ambient temp.

FP - Polyurethane air filter

TD - Differential fluid temperature management (two sensors)

BGC - Hot gas bypass for $\pm 1\text{ K}$ temperature precision

LS - Liquid circuit for laser application

- HIGH-pressure pump version "H" - 5 bar

DIMENSIONS

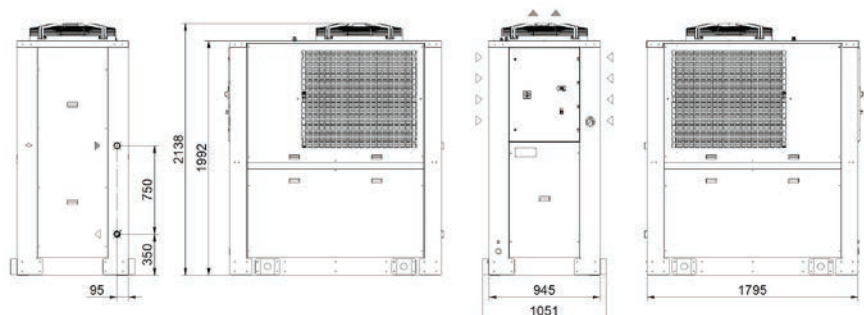



Model		TALD0	TALD9	TALE6	TALF8
Rated Cooling Capacity*	W	40000	47000	55000	67000
Ambient temperature operating limits	°C	+15 - +45			
Settable fluid temperature range	°C	+8 - +25			
Fluid type		Water			
Temperature precision	K	+/-2			
Refrigerant gas	HFC	R410A			
Power supply					
Supply voltage	V ph Hz	400 V (+/-10%) 3 ph 50 Hz			
Secondary supply voltage	V	24 V AC			
Digital thermostat		TX350C			
Compressor					
Compressor type		Scroll			
Quantity - Number of circuits	no.	1 - 1			2 - 1
Max. power draw	kW	9.4	10.4	12.1	25.0
Axial Fan					
Fan type		Axial			
Quantity	no.	1	1	1	1
Air flow rate	m³/h	12600	14400	16000	24000
Centrifugal Fan (optional)					
Fan type		Centrifugal			
Quantity	no.	1	1	1	1
Air flow rate	m³/h	12600	14400	16000	24000
Available head	Pa	570	350	200	150
Standard Pump					
Pump type		Centrifugal			
Quantity	no.	1	1	1	1
Nominal/max fluid flow rate	l/min	115 - 230	135 - 230	158 - 230	200 - 230
Nominal available head	bar	3.8	3.6	4.6	3.8
High Pressure Pump					
Pump type		Centrifugal			
Quantity	no.	1	1	1	1
Nominal available head	bar	6.5	6.2	6.7	5.7
Storage tank capacity					
Storage tank capacity	l	200			
IN/OUT liquid connections	inch	1 1/2"			
Net weight (approximate)***	kg	580	600	600	600
Width - Depth - Height	mm	945 - 1795 - 2138			
Sound pressure level**	dB (A)	75	75	75	78

* Data relates to operation under the following conditions: inlet/outlet temp. 20/15°C, water without glycol, ambient temperature 32°C.

** Sound pressure level, measured in a free parallelepiped field at a distance of 1 m, per ISO 3746.

*** Weight includes pallets and packaging (where provided for), with refrigerant charge, storage tank empty, axial fans.

The electrical data refer to $\cos \varphi = 0.8$.

Correction factors for calculating the cooling power													
Water outlet temperature	Fw	°C					8	10	15	20	25		
		factor					0.77	0.83	1	1.20	1.41		
Ambient Temperature	Fa	°C					15	20	25	32	35	40	45
		factor					1.27	1.2	1.13	1	0.95	0.86	0.80
Percentage glycol by weight	Fg	%	0	10	15	20	25	30	35	40			
		factor	1	0.96	0.95	0.94	0.93	0.91	0.90	0.88			
Cooling power = Nominal cooling power x Fw x Fa x Fg													

C-Next TALG9÷06 Size 5

Industrial water chillers

COOLING CAPACITY

80000 - 94000 - 110000 - 134000 W



STRUCTURE

In powder-coated steel sheet, RAL 7035 textured finish. Easily removed panels

COMPRESSOR

Hermetic scroll compressor, cooled by the refrigerant, complete with thermal cut-out.

REFRIGERATION CIRCUIT

Complete with charging port, liquid receiver, drier filter, thermostatic valve, high- and low-pressure pressure switch, R410A refrigerant. Stepped cooling power regulation - 2 steps standard / 4 steps optional (standard on TAL06).

EVAPORATOR

Brazed stainless-steel plate model.

AIR CONDENSER

Microchannel condensing coil, complete with safety grille.

AXIAL FAN

Axial fan, complete with thermal cut-out and safety grille.

LIQUID CIRCUIT

Non-ferrous liquid circuit composed of stainless steel centrifugal electric pump, storage tank made of plastic material complete with drain valve, electrical level indicator, 0-10 bar pressure gauge, differential pressure switch protecting the water flow, automatic by-pass and regulation sensor.

ELECTRICAL PANEL

With main disconnect switch, relay motor protection, phase sequence relays.

MANAGEMENT AND CONTROL

The TX350C control unit manages the operation of the chiller and provides complete operator alarm diagnostics. An on-off contact allows the machine to be switched on remotely. Illuminated control selector. RS485 connection. Possibility of remote display for machine regulation.

PAINT/COATING

Standard colour: RAL 7035 textured.

MAIN OPTIONS

FL - Flow switch with alarm contact

HR - Fluid heating element

OM - Unit built for outdoor operation down to -10°C ambient temp.

OML - Unit built for outdoor operation down to -20°C ambient temp.

FP - Polyurethane air filter

TD - Differential fluid temperature management (two sensors)

BGC - Hot gas bypass for $\pm 1\text{ K}$ temperature precision

LS - Liquid circuit for laser application

- HIGH-pressure pump version "H" - 5 bar

DIMENSIONS

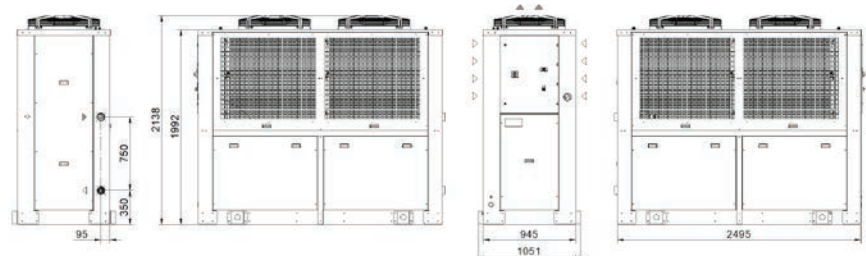



Model		TALG9	TALI4	TALM0	TALO6
Rated Cooling Capacity*	W	80000	94000	110000	134000
Ambient temperature operating limits	°C	+15 - +45			
Settable fluid temperature range	°C	+8 - +25			
Fluid type		Water			
Temperature precision	K	+/-2			
Refrigerant gas	HFC	R410A			
Power supply					
Supply voltage	V ph Hz	400 V (+/-10%) 3 ph 50 Hz			
Secondary supply voltage	V	24 V AC			
Digital thermostat		TX350C			
Compressor					
Compressor type		Scroll			
Quantity - Number of circuits	no.	2 - 2			4 - 2
Max. power draw	kW	18.8	20.8	24.2	50.0
Axial Fan					
Fan type		Axial			
Quantity	no.	2	2	2	2
Air flow rate	m³/h	25200	28800	32000	48000
Centrifugal Fan (optional)					
Fan type		Centrifugal			
Quantity	no.	2	2	2	2
Air flow rate	m³/h	25200	28800	32000	48000
Available head	Pa	570	350	200	150
Standard Pump					
Pump type		Centrifugal			
Quantity	no.	1	1	1	1
Nominal/max fluid flow rate	l/min	230 - 400	270 - 400	316 - 400	400 - 400
Nominal available head	bar	4.7	4.4	4	3.6
High Pressure Pump					
Pump type		Centrifugal			
Quantity	no.	1	1	1	1
Nominal available head	bar	6	5.5	5	5
Storage tank capacity					
Storage tank capacity	l	300			
IN/OUT liquid connections	inch	2"1/2			
Net weight (approximate)***	kg	730	750	750	750
Width - Depth - Height	mm	945 - 2495 - 2139			
Sound pressure level**	dB (A)	75	75	75	78

* Data relates to operation under the following conditions: inlet/outlet temp. 20/15°C, water without glycol, ambient temperature 32°C.

** Sound pressure level, measured in a free parallelepiped field at a distance of 1 m, per ISO 3746.

*** Weight includes pallets and packaging (where provided for), with refrigerant charge, storage tank empty, axial fans.

The electrical data refer to cos φ = 0.8.

Correction factors for calculating the cooling power													
Water outlet temperature	Fw	°C					8	10	15	20	25		
		factor					0.77	0.83	1	1.20	1.41		
Ambient Temperature	Fa	°C					15	20	25	32	35	40	45
		factor					1.27	1.2	1.13	1	0.95	0.86	0.80
Percentage glycol by weight	Fg	%	0	10	15	20	25	30	35	40			
		factor	1	0.96	0.95	0.94	0.93	0.91	0.90	0.88			
Cooling power = Nominal cooling power x Fw x Fa x Fg													



TCO - TAO

Industrial oil chillers

TCO-TAO oil chillers provide precision and reliability in a compact and modular design. With outputs from 800 W up to 67 kW.



TC008÷19 Minichiller

Industrial oil chillers

COOLING CAPACITY

900-1100 - 1600-1900 - 2200-2550 W



STRUCTURE

In powder-coated steel sheet, RAL 7035 textured finish. Easily removed panels

COMPRESSOR

Hermetic reciprocating compressor, cooled by the refrigerant, complete with thermal cut-out.

REFRIGERATION CIRCUIT

Complete with charging port, drier filter, expansion valve, high- and low-pressure safety pressure switch, R134a refrigerant.

EVAPORATOR

Brazed stainless-steel plate model.

AIR CONDENSER

Finned high-efficiency copper tube condensing coil, complete with safety grille.

AXIAL FAN

Axial fan, complete with electrical protection and safety grille.

HYDRAULIC CIRCUIT

Hydraulic circuit with gear pump without tank, with maximum available pressure 20 bar, 0–25 bar pressure gauge, regulation temperature sensor. Hydraulic safety with safety low- and high-pressure pressure switch.

ELECTRICAL PANEL

With main breaker, fused motor protection with LED visual fault indicator, voltage presence light.

MANAGEMENT AND CONTROL

The TX110 control unit manages the chiller's operation, providing warnings including high/low temperature alarms and a general serious fault alarm, with the display indicating if this refers to the refrigeration or hydraulic circuit. An on-off contact allows the machine to be switched on remotely. Control disconnect switch for switching on the machine.

PAINT/COATING

Standard colour: RAL 7035 textured.

MAIN OPTIONS

LTA - Operation at low ambient temperatures

FP - Polyurethane air filter

RU - Castors

TD - Differential fluid temperature management (two sensors)

BGC - Hot gas bypass for ± 1 K temperature precision

FL - Customer flow switch

- Non-standard paint/coating
- Satin AISI 304 stainless steel framework

DIMENSIONS

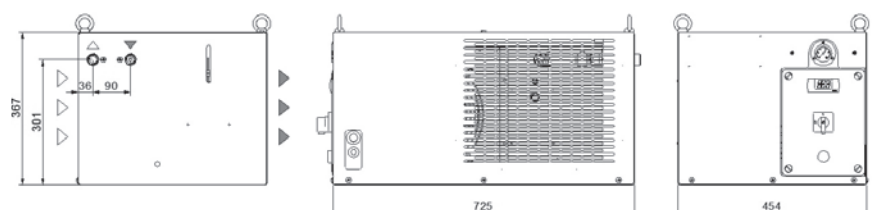



Model		TC008		TC012		TC019	
		50 Hz	60 Hz	50 Hz	60 Hz	50 Hz	60 Hz
Rated Cooling Capacity*	W	900	1100	1600	1900	2200	2550
Ambient temperature operating limits	°C	+15 - +45					
Settable oil temperature range	°C	+25 - +40					
Fluid type		ISO VG 32					
Temperature precision	K	+/-2					
Refrigerant gas	HFC	R134a					
Power supply							
Supply voltage	V ph Hz	230 V (+/-10%) 1 ph 50/60 Hz					
Secondary supply voltage	V AC	230					
Digital thermostat		TX110					
Compressor							
Compressor type		Reciprocating					
Quantity - Number of circuits	no.	1 - 1					
Max. power draw	kW	0.5	0.6	0.7	1.1	1.0	1.15
Max. current draw	A	2.8	3.1	4.1	4.3	6.0	6.5
Axial Fan							
Fan type		Axial					
Quantity	no.	1		1		1	
Air flow rate	m³/h	1000		1000		1000	
Max. power draw	W	150	190	150	190	150	190
Max. current draw	A	0.66	0.85	0.66	0.85	0.66	0.85
Standard Pump							
Pump type		Gear pump					
Quantity	no.	1		1		1	
Nominal fluid flow rate	l/min	10		10		10	
Nominal available head	bar	20		20		20	
Max. power draw	kW	0.55		0.55		0.55	
Max. current draw	A	4.0	4.2	4.0	4.2	4.0	4.2
Storage tank capacity (optional)	l	10					
IN/OUT liquid connections	inch	1/2"					
Net weight (approximate)**	kg	59		61		63	
Width - Depth - Height	mm	725 - 454 - 367					
Sound pressure level**	dB (A)	56		56		56	
IP rating	IP	44					

* Data relating to operation under the following conditions: intake/outlet temperature 40/30°C, ISO VG 32 oil, ambient temperature 32°C. Cooling power refers to the evaporator unit.

** Sound pressure level at 50 Hz, measured in a free hemispherical field at a distance of 1 m from the machine and 1.5 metres from the ground, per ISO 3746.

*** Weight includes pallets and packaging (where provided for), with refrigerant charge, without storage tank and axial fans.

The electrical data refer to cos φ = 0.8.

Correction factors for calculating the cooling power												
Oil outlet temperature	Fo	°C	20	25	30	35						
		factor	0.82	0.92	1	1.05						
Ambient Temperature	Fa	°C				15	20	25	32	35	40	45
		factor				1.16	1.1	1.05	1	0.97	0.91	0.84
Oil type	Ft	type	ISO VG 10		ISO VG 22		ISO VG 32		ISO VG 46		ISO VG 68	
		factor	1.15		1.1		1		0.9		0.82	

Cooling power = Nominal cooling power x Fo x Fa x Ft

TCO31-41 Minichiller HP

Industrial oil chillers

COOLING CAPACITY

3000-3450 - 3900-4450 W



STRUCTURE

In powder-coated steel sheet, RAL 7035 textured finish. Easily removed panels

COMPRESSOR

Hermetic reciprocating compressor, cooled by the refrigerant, complete with thermal cut-out.

REFRIGERATION CIRCUIT

Complete with charging port, drier filter, expansion valve, high- and low-pressure safety pressure switch, R134a refrigerant.

EVAPORATOR

Brazed stainless-steel plate model.

AIR CONDENSER

Finned high-efficiency copper tube condensing coil, complete with safety grille.

AXIAL FAN

Axial fan, complete with electrical protection and safety grille.

HYDRAULIC CIRCUIT

Hydraulic circuit with gear pump without tank, with maximum available pressure 20 bar, 0–25 bar pressure gauge, regulation temperature sensor. Hydraulic safety with safety low- and high-pressure pressure switch.

ELECTRICAL PANEL

With main breaker, fused motor protection with LED visual fault indicator, voltage presence light.

MANAGEMENT AND CONTROL

The TX110 control unit manages the chiller's operation, providing warnings including high/low temperature alarms and a general serious fault alarm, with the display indicating if this refers to the refrigeration or hydraulic circuit. An on-off contact allows the machine to be switched on remotely. Control disconnect switch for switching on the machine.

PAINT/COATING

Standard colour: RAL 7035 textured.

MAIN OPTIONS

LTA - Operation at low ambient temperatures

FP - Polyurethane air filter

RU - Castors

TD - Differential fluid temperature management (two sensors)

BGC - Hot gas bypass for +/-1 K temperature precision

FL - Customer flow switch

- Non-standard paint/coating
- Satin AISI 304 stainless steel framework

DIMENSIONS

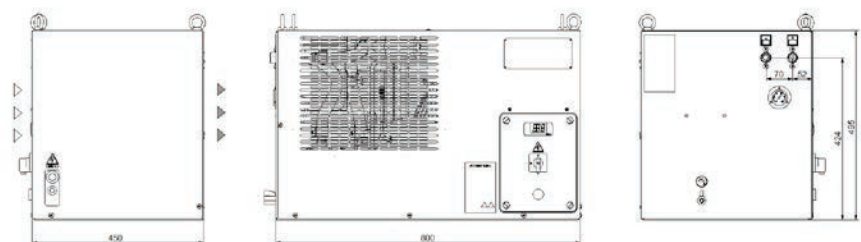



Model		TC031		TC041	
		50 Hz	60 Hz	50 Hz	60 Hz
Rated Cooling Capacity*	W	3000	3450	3900	4450
Ambient temperature operating limits	°C	+15 - +45			
Settable oil temperature range	°C	+25 - +40			
Fluid type		ISO VG 32			
Temperature precision	K	+/-2			
Refrigerant gas	HFC	R134a			
Power supply					
Supply voltage	V ph Hz	230 V (+/-10%) 1 ph 50/60 Hz			
Secondary supply voltage	V AC	230			
Digital thermostat		TX110			
Compressor					
Compressor type		Reciprocating			
Quantity - Number of circuits	no.	1 - 1			
Max. power draw	kW	1.15	1.5	1.6	1.92
Max. current draw	A	6.1	8.1	7.2	8.4
Axial Fan					
Fan type		Axial			
Quantity	no.	1		1	
Air flow rate	m³/h	2300	2650	2300	2650
Max. power draw	W	180	250	180	250
Max. current draw	A	0.81	1.1	0.81	1.1
Standard Pump					
Pump type		Gear pump			
Quantity	no.	1			
Nominal fluid flow rate	l/min	10		10	
Nominal available head	bar	20		20	
Max. power draw	kW	0.55		0.55	
Max. current draw	A	4.0	4.2	4.0	4.2
IN/OUT liquid connections	inch	1/2"			
Net weight (approximate)***	kg	74		75	
Width - Depth - Height	mm	800 - 450 - 495			
Sound pressure level**	dB (A)	57	60	57	60
IP rating	IP	44			

* Data relating to operation under the following conditions: intake/outlet temperature 40/30°C, ISO VG 32 oil, ambient temperature 32°C. Cooling power refers to the evaporator unit.

** Sound pressure level at 50 Hz, measured in a free hemispherical field at a distance of 1 m from the machine and 1.5 metres from the ground, per ISO 3746.

*** Weight includes pallets and packaging (where provided for), with refrigerant charge, without storage tank and axial fans.

The electrical data refer to cos φ = 0.8.

Correction factors for calculating the cooling power												
Oil outlet temperature	Fo	°C	20	25	30	35						
		factor	0.82	0.92	1	1.05						
Ambient Temperature	Fa	°C				15	20	25	32	35	40	45
		factor				1.16	1.1	1.05	1	0.97	0.91	0.84
Oil type	Ft	type	ISO VG 10		ISO VG 22		ISO VG 32		ISO VG 46		ISO VG 68	
		factor	1.15		1.1		1		0.9		0.82	
Cooling power = Nominal cooling power x Fo x Fa x Ft												

C-NEXT TAO24-37 Size 1

Industrial oil chillers

COOLING CAPACITY

2300-2700 - 3600-4200 W



STRUCTURE

In powder-coated steel sheet, RAL 7035 textured finish. Easily removed panels

COMPRESSOR

Hermetic scroll compressor, cooled by the refrigerant, complete with thermal cut-out.

REFRIGERATION CIRCUIT

Complete with charging port, liquid receiver, drier filter, thermostatic valve, high- and low-pressure pressure switch, R410A refrigerant. Stepped cooling power regulation - 2 steps standard / 4 steps optional (standard on TAL06).

EVAPORATOR

Brazed stainless-steel plate model.

AIR CONDENSER

Microchannel condensing coil, complete with safety grille.

AXIAL FAN

Axial fan, complete with thermal cut-out and safety grille.

LIQUID CIRCUIT

Non-ferrous liquid circuit composed of stainless steel centrifugal electric pump, storage tank made of plastic material complete with drain valve, electrical level indicator, 0–10 bar pressure gauge, differential pressure switch protecting the water flow, automatic by-pass and regulation sensor.

ELECTRICAL PANEL

With main disconnect switch, relay motor protection, phase sequence relays.

MANAGEMENT AND CONTROL

The TX350C control unit manages the operation of the chiller and provides complete operator alarm diagnostics. An on-off contact allows the machine to be switched on remotely. Illuminated control selector. RS485 connection. Possibility of remote display for machine regulation.

PAINT/COATING

Standard colour: RAL 7035 textured.

MAIN OPTIONS

FL - Flow switch with alarm contact

HR - Fluid heating element

OM - Unit built for outdoor operation down to -10°C ambient temp.

OML - Unit built for outdoor operation down to -20°C ambient temp.

FP - Polyurethane air filter

TD - Differential fluid temperature management (two sensors)

BGC - Hot gas bypass for $\pm 1\text{ K}$ temperature precision

LS - Liquid circuit for laser application

- HIGH-pressure pump version "H" - 5 bar

DIMENSIONS

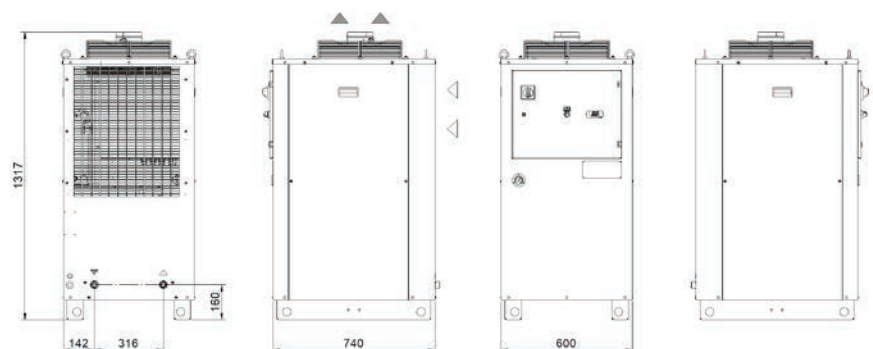



Model		TA024		TA037	
		50 Hz	60 Hz	50 Hz	60 Hz
Rated Cooling Capacity*	W	2300	2700	3600	4200
Ambient temperature operating limits	°C	+15 - +45			
Settable fluid temperature range	°C	+25 - +40			
Fluid type		ISO VG 32			
Temperature precision	K	+/-2			
Refrigerant gas	HFC	R134a			
Power supply					
Supply voltage	V ph Hz	230 V (+/-10%) 1 ph 50/60 Hz			
Secondary supply voltage	V	230 V AC			
Digital thermostat		TX110			
Compressor					
Compressor type		Reciprocating			
Quantity - Number of circuits	no.	1 - 1			
Nominal power draw	kW	0.84	1.04	1.16	1.5
Axial Fan					
Fan type		Axial			
Quantity	no.	1			
Air flow rate	m³/h	1250 - 1650		1550 - 2050	
Centrifugal Fan (optional)					
Fan type		Centrifugal			
Quantity	no.	1			
Air flow rate	m³/h	2100 - 2400		2100 - 2400	
Available head	Pa	250			
Standard Pump					
Pump type		Gear pump			
Quantity	no.	1			
Nominal/max fluid flow rate	l/min	10		20	
Nominal available head	bar	10		10	
Storage tank capacity (optional)					
Storage tank capacity (optional)	l	50			
IN/OUT liquid connections	inch	3/4"			
Net weight (approximate)**	kg	151		153	
Width - Depth - Height	mm	600 - 740 - 1317			
Height with tank and pump	mm	1790			
Sound pressure level**	dB (A)	57	60	57	60

* Data relates to operation under the following conditions: inlet/outlet oil temp. 40/30°C, ISO VG 32 oil, ambient temperature 32°C.

** Sound pressure level, measured in a free parallelepiped field at a distance of 1 m, per ISO 3746.

*** Weight includes pallets and packaging (where provided for), with refrigerant charge, without storage tank and axial fans.

The electrical data refer to cos φ = 0.8.

Correction factors for calculating the cooling power												
Oil outlet temperature	Fo	°C	20	25	30	35						
		factor	0.59	0.77	1	1.22						
Ambient Temperature	Fa	°C				15	20	25	32	35	40	45
		factor				1.26	1.2	1.11	1	0.95	0.87	0.80
Oil type	Ft	type	ISO VG 10		ISO VG 22		ISO VG 32		ISO VG 46		ISO VG 68	
		factor	1.15		1.1		1		0.9		0.82	
Cooling power = Nominal cooling power x Fo x Fa x Ft												



C-NEXT TAO29÷A0 Size 1 Three-phase

Industrial oil chillers

COOLING CAPACITY

2900 - 3600 - 4550 - 6000 - 8100 - 9550 - 10900 W



STRUCTURE

In powder-coated steel sheet, RAL 7035 textured finish. Easily removed panels

COMPRESSOR

Hermetic Reciprocating or Scroll compressor, cooled by the refrigerant, complete with thermal cut-out.

REFRIGERATION CIRCUIT

Complete with charging port, drier filter, expansion or thermostatic valve, high-pressure pressure switch, R134a refrigerant.

EVAPORATOR

Brazed stainless-steel plate model.

AIR CONDENSER

Finned high-efficiency copper tube condensing coil, complete with safety grille.

AXIAL FAN

Axial fan, complete with thermal cut-out and safety grille.

HYDRAULIC CIRCUIT

Hydraulic circuit with gear pump without tank, with maximum available pressure 10 bar, 0–25 bar pressure gauge, regulation temperature sensor. Hydraulic safety with low-pressure safety pressure switch.

ELECTRICAL PANEL

With main disconnect switch, relay motor protection, phase sequence relays.

MANAGEMENT AND CONTROL

The TX110 control unit manages the chiller's operation, providing warnings including high/low temperature alarms and a general serious fault alarm, with the display indicating if this refers to the refrigeration or hydraulic circuit. An on-off contact allows the machine to be switched on remotely (pump included). Control disconnect switch for switching on the machine.

PAINT/COATING

Standard colour: RAL 7035 textured.

MAIN OPTIONS

BA - Mechanical bypass valve protecting the pump

LTA - Operation at low ambient temperatures

FP - Polyurethane air filter

RU - Castors

TD - Differential fluid temperature management (two sensors)

BGC - Hot gas bypass for +/-1 K temperature precision

BGP - Hot gas bypass for +/-0.5 K temperature precision

UL1 - Electrical panel and UL-certified components

- Outdoor installation options

DIMENSIONS

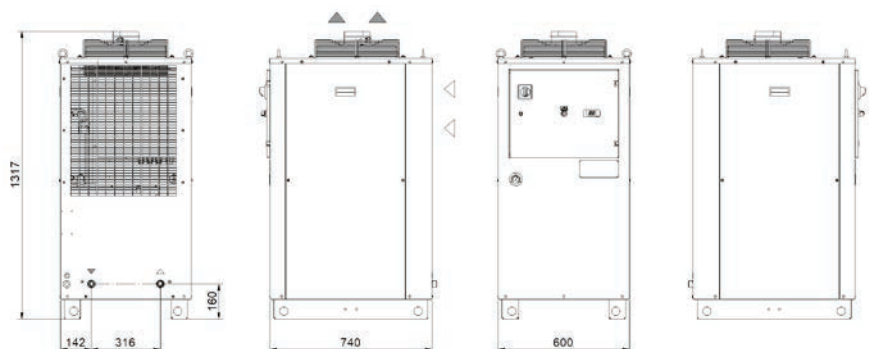



Model		TA029	TA037	TA046	TA057	TA076	TA093	TA0A0	
Rated Cooling Capacity*	W	2900	3600	4550	6000	8100	9550	10900	
Ambient temperature operating limits	°C	+15 - +45							
Settable fluid temperature range	°C	+25 - +40							
Fluid type		ISO VG 32							
Temperature precision	K	+/-2							
Refrigerant gas	HFC	R134a							
Power supply									
Supply voltage	V ph Hz	400 V (+/-10%) 3 ph 50 Hz							
Secondary supply voltage	V	230 V AC							
Digital thermostat		TX110							
Compressor									
Compressor type		Reciprocating				Scroll			
Quantity - Number of circuits	no.	1 - 1							
Nominal power draw	kW	0.78	1.16	1.42	2.42	2.21	2.60	2.73	
Axial Fan									
Fan type		Axial							
Quantity	no.	1							
Air flow rate	m³/h	1550	1550	1800	1800	3150	3350	4400	
Centrifugal Fan (optional)									
Fan type		Centrifugal							
Quantity	no.	1							
Air flow rate	m³/h	2100 - 2400	2100 - 2400	2100 - 2400	2100 - 2400	2100 - 2400	2100 - 2400	2100 - 2400	
Available head	Pa	250							
Standard Pump									
Pump type		Gear pump							
Quantity	no.	1							
Nominal fluid flow rate	l/min	10	20	20	20	30	40	40	
Nominal available head	bar	10	10	10	10	10	10	10	
Storage tank capacity (optional)									
Storage tank capacity (optional)	l	50							
IN/OUT liquid connections	inch	3/4"							
Net weight (approximate)***	kg	151	153	155	160	165	170	175	
Width - Depth - Height	mm	600 - 740 - 1317							
Height with tank and pump	mm	1790							
Sound pressure level**	dB (A)	57	57	57	57	57	57	57	

* Data relates to operation under the following conditions: inlet/outlet oil temp. 40/30°C, ISO VG 32 oil, ambient temperature 32°C.

** Sound pressure level, measured in a free parallelepiped field at a distance of 1 m, per ISO 3746.

*** Weight includes pallets and packaging (where provided for), with refrigerant charge, without storage tank and axial fans.

The electrical data refer to $\cos \varphi = 0.8$.

Correction factors for calculating the cooling power												
Oil outlet temperature	Fo	°C	20	25	30	35						
		factor	0.59	0.77	1	1.22						
Ambient Temperature	Fa	°C				15	20	25	32	35	40	45
		factor				1.26	1.2	1.11	1	0.95	0.87	0.80
Oil type	Ft	type	ISO VG 10		ISO VG 22		ISO VG 32		ISO VG 46		ISO VG 68	
		factor	1.15		1.1		1		0.9		0.82	
Cooling power = Nominal cooling power x Fo x Fa x Ft												

C-NEXT TAOA1÷A8 Size 2

Industrial oil chillers

COOLING CAPACITY

11400 - 12400 - 17800 - 20100 W



STRUCTURE

In powder-coated steel sheet, RAL 7035 textured finish. Easily removed panels

COMPRESSOR

Hermetic scroll compressor, cooled by the refrigerant, complete with thermal cut-out.

REFRIGERATION CIRCUIT

Complete with charging port, liquid receiver, drier filter, thermostatic valve, high- and low-pressure pressure switch, R410A refrigerant.

EVAPORATOR

Brazed stainless-steel plate model.

AIR CONDENSER

Microchannel condensing coil, complete with safety grille.

AXIAL FAN

Axial fan, complete with thermal cut-out and safety grille.

HYDRAULIC CIRCUIT

Hydraulic circuit with screw pump without tank, with maximum available pressure 10 bar, high- and low-pressure safety pressure switch, 0–25 bar oil pressure gauge, regulation sensor.

ELECTRICAL PANEL

With main disconnect switch, relay motor protection, phase sequence relays.

MANAGEMENT AND CONTROL

The TX200 control unit manages the operation of the chiller and provides complete operator alarm diagnostics. An on-off contact allows the machine to be switched on remotely. Illuminated control selector. Possibility of remote display for machine regulation.

PAINT/COATING

Standard colour: RAL 7035 textured.

MAIN OPTIONS

BA - Mechanical bypass valve protecting the pump

LTA - Operation at low ambient temperatures

FP - Polyurethane air filter

RU - Castors

TD - Differential fluid temperature management (two sensors)

BGC - Hot gas bypass for ± 1 K temperature precision

BGP - Hot gas bypass for ± 0.5 K temperature precision

UL1 - Electrical panel and UL-certified components

HP/HS - Harting-type connector

- Outdoor installation options

DIMENSIONS

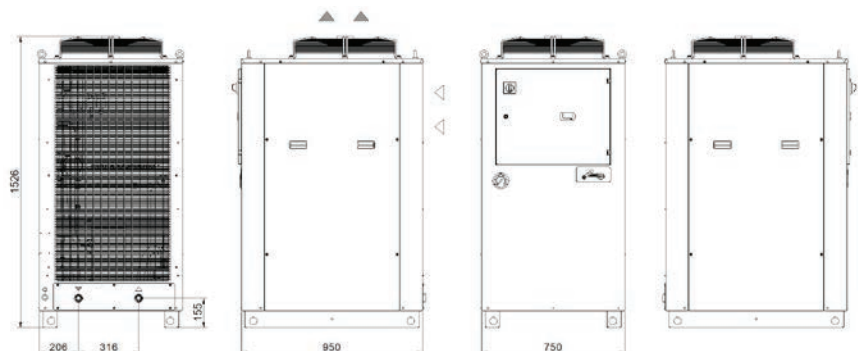



Model		TAOA1	TAOA3	TAOA5	TAOA8
Rated Cooling Capacity*	W	11400	12400	17800	20100
Ambient temperature operating limits	°C	+15 - +45			
Settable fluid temperature range	°C	+25 - +40			
Fluid type		ISO VG 32			
Temperature precision	K	+/-2			
Refrigerant gas	HFC	R410A			
Power supply					
Supply voltage	V ph Hz	400 V (+/-10%) 3 ph 50 Hz			
Secondary supply voltage	V	24 V AC			
Digital thermostat		TX200			
Compressor					
Compressor type		Scroll			
Quantity - Number of circuits	no.	1 - 1			
Nominal power draw	kW	3.03	3.12	4.08	4.91
Axial Fan					
Fan type		Axial			
Quantity	no.	1			
Air flow rate	m³/h	6500	6500	6500	6500
Centrifugal Fan (optional)					
Fan type		Centrifugal			
Quantity	no.	1			
Air flow rate	m³/h	6500	6500	6500	6500
Available head	Pa	250			
Standard Pump					
Pump type		Screw pump			
Quantity	no.	1			
Nominal/max fluid flow rate	l/min	70	70	70	70
Nominal available head	bar	10	10	10	10
Storage tank capacity (optional)					
Storage tank capacity (optional)	l	130			
IN/OUT liquid connections	inch	1"			
Net weight (approximate)***	kg	200	200	235	235
Width - Depth - Height	mm	750 - 950 - 1526			
Height with tank and pump	mm	1998			
Sound pressure level**	dB (A)	67	67	67	67

* Data relates to operation under the following conditions: inlet/outlet oil temp. 40/30°C, ISO VG 32 oil, ambient temperature 32°C.

** Sound pressure level, measured in a free parallelepiped field at a distance of 1 m, per ISO 3746.

*** Weight includes pallets and packaging (where provided for), with refrigerant charge, without storage tank and axial fans.

The electrical data refer to cos φ = 0.8.

Correction factors for calculating the cooling power												
Oil outlet temperature	Fo	°C	20	25	30	35						
		factor	0.74	0.82	1	1.22						
Ambient Temperature	Fa	°C				15	20	25	32	35	40	45
		factor				1.26	1.2	1.12	1	0.95	0.87	0.80
Oil type	Ft	type	ISO VG 10		ISO VG 22		ISO VG 32		ISO VG 46		ISO VG 68	
		factor	1.15		1.1		1		0.9		0.82	
Cooling power = Nominal cooling power x Fo x Fa x Ft												

C-NEXT TAOB5÷C5 Size 3

Industrial oil chillers

COOLING CAPACITY

24800 - 29000 - 35800 W



STRUCTURE

In powder-coated steel sheet, RAL 7035 textured finish. Easily removed panels

COMPRESSOR

Hermetic scroll compressor, cooled by the refrigerant, complete with thermal cut-out.

REFRIGERATION CIRCUIT

Complete with charging port, liquid receiver, drier filter, thermostatic valve, high- and low-pressure pressure switch, R410A refrigerant.

EVAPORATOR

Brazed stainless-steel plate model.

AIR CONDENSER

Microchannel condensing coil, complete with safety grille.

AXIAL FAN

Axial fan, complete with thermal cut-out and safety grille.

HYDRAULIC CIRCUIT

Hydraulic circuit with screw pump without tank, with maximum available pressure 10 bar, high- and low-pressure safety pressure switch, 0–25 bar oil pressure gauge, regulation sensor.

ELECTRICAL PANEL

With main disconnect switch, relay motor protection, phase sequence relays.

MANAGEMENT AND CONTROL

The TX200 control unit manages the operation of the chiller and provides complete operator alarm diagnostics. An on-off contact allows the machine to be switched on remotely. Illuminated control selector. Possibility of remote display for machine regulation.

PAINT/COATING

Standard colour: RAL 7035 textured.

MAIN OPTIONS

BA - Mechanical bypass valve protecting the pump

LTA - Operation at low ambient temperatures

FP - Polyurethane air filter

RU - Castors

TD - Differential fluid temperature management (two sensors)

BGC - Hot gas bypass for ± 1 K temperature precision

BGP - Hot gas bypass for ± 0.5 K temperature precision

UL1 - Electrical panel and UL-certified components

HP/HS - Harting-type connector

- Outdoor installation options

DIMENSIONS

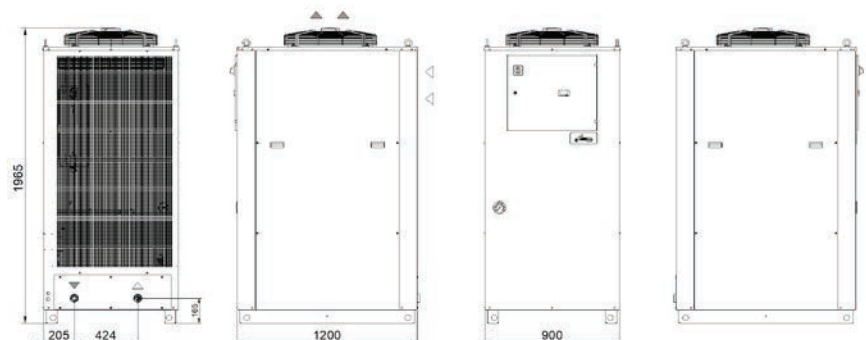

Model		TAOB5	TAOB9	TAOC5
Rated Cooling Capacity*	W	24800	29000	35800
Ambient temperature operating limits	°C	+15 - +45		
Settable fluid temperature range	°C	+25 - +40		
Fluid type		ISO VG 32		
Temperature precision	K	+/-2		
Refrigerant gas	HFC	R410A		
Power supply				
Supply voltage	V ph Hz	400 V (+/-10%) 3 ph 50 Hz		
Secondary supply voltage	V	24 V AC		
Digital thermostat		TX200		
Compressor				
Compressor type		Scroll		
Quantity - Number of circuits	no.	1 - 1		
Nominal power draw	kW	6.4	7.4	8.6
Axial Fan				
Fan type		Axial		
Quantity	no.	1		
Air flow rate	m³/h	8300	9700	11500
Centrifugal Fan (optional)				
Fan type		Centrifugal		
Quantity	no.	1		
Air flow rate	m³/h	8300	9700	11500
Available head	Pa	370	180	100
Standard Pump				
Pump type		Screw pump		
Quantity	no.	1		
Nominal/max fluid flow rate	l/min	120	120	120
Nominal available head	bar	10	10	10
Storage tank capacity (optional)				
Storage tank capacity (optional)	l	130		
IN/OUT liquid connections	inch	1 1/2"		
Net weight (approximate)***	kg	260	260	260
Width - Depth - Height	mm	900 - 1200 - 1965		
Sound pressure level**	dB (A)	67	67	67

* Data relates to operation under the following conditions: inlet/outlet oil temp. 40/30°C, ISO VG 32 oil, ambient temperature 32°C.

** Sound pressure level, measured in a free parallelepiped field at a distance of 1 m, per ISO 3746.

*** Weight includes pallets and packaging (where provided for), with refrigerant charge, without storage tank and axial fans.

The electrical data refer to $\cos \varphi = 0.8$.

Correction factors for calculating the cooling power												
Oil outlet temperature	Fo	°C	20	25	30	35						
		factor	0.71	0.84	1	1.18						
Ambient Temperature	Fa	°C				15	20	25	32	35	40	45
		factor				1.25	1.2	1.09	1	0.97	0.91	0.87
Oil type	Ft	type	ISO VG 10		ISO VG 22		ISO VG 32		ISO VG 46		ISO VG 68	
		factor	1.15		1.1		1		0.9		0.82	
Cooling power = Nominal cooling power x Fo x Fa x Ft												

C-NEXT TAOD0÷F8 Size 4

Industrial oil chillers

COOLING CAPACITY

40000 - 47000 - 55000 - 67000 W



STRUCTURE

In powder-coated steel sheet, RAL 7035 textured finish. Easily removed panels.

COMPRESSOR

Hermetic scroll compressor, cooled by the refrigerant, complete with thermal cut-out.

REFRIGERATION CIRCUIT

Complete with charging port, liquid receiver, drier filter, thermostatic valve, high- and low-pressure pressure switch, R410A refrigerant. Optional 2-step cooling power regulation (standard on TAOF8).

EVAPORATOR

Brazed stainless-steel plate model.

AIR CONDENSER

Microchannel condensing coil, complete with safety grille.

AXIAL FAN

Axial fan, complete with thermal cut-out and safety grille..

HYDRAULIC CIRCUIT

Hydraulic circuit with screw pump without tank, with maximum available pressure 10 bar, 0–25 bar pressure gauge, regulation temperature sensor. Hydraulic safety with protective flow switch.

ELECTRICAL PANEL

With main disconnect switch, relay motor protection, phase sequence relays.

MANAGEMENT AND CONTROL

The TX350C control unit manages the operation of the chiller and provides complete operator alarm diagnostics. An on-off contact allows the machine to be switched on remotely. Illuminated control selector. RS485 connection. Possibility of remote display for machine regulation.

PAINT/COATING

Standard colour: RAL 7035 textured.

MAIN OPTIONS

- BA - Mechanical bypass valve protecting the pump
- LTA - Operation at low ambient temperatures
- OM - Unit built for outdoor operation down to -10°C ambient temp.
- FP - Polyurethane air filter
- TD - Differential fluid temperature management (two sensors)
- BGC - Hot gas bypass for $\pm 1\text{ K}$ temperature precision
- UL1 - Electrical panel and UL-certified components
- Outdoor installation options

DIMENSIONS

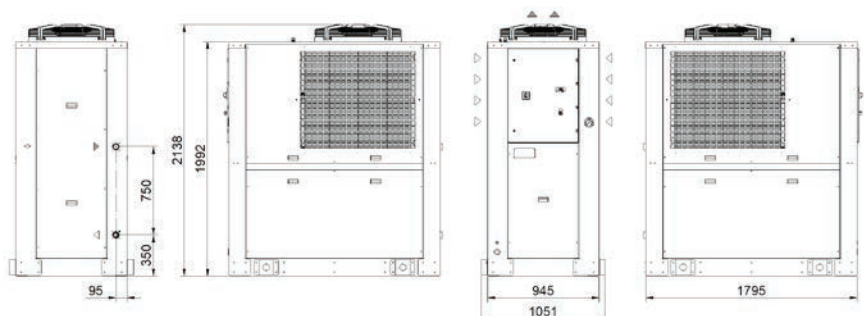



Model		TAOD0	TAOD9	TAOE6	TAOF8
Rated Cooling Capacity*	W	40000	47000	55000	67000
Ambient temperature operating limits	°C	+15 - +45			
Settable fluid temperature range	°C	+25 - +40			
Fluid type		ISO VG 32			
Temperature precision	K	+/-2			
Refrigerant gas	HFC	R410A			
Power supply					
Supply voltage	V ph Hz	400 V (+/-10%) 3 ph 50 Hz			
Secondary supply voltage	V	24 V AC			
Digital thermostat		TX350C			
Compressor					
Compressor type		Scroll			
Quantity - Number of circuits	no.	1 - 1			2 - 1
Max. power draw	kW	9.4	10.4	12.1	25.0
Axial Fan					
Fan type		Axial			
Quantity	no.	1	1	1	1
Air flow rate	m³/h	12600	14400	16000	24000
Centrifugal Fan (optional)					
Fan type		Centrifugal			
Quantity	no.	1	1	1	1
Air flow rate	m³/h	12600	14400	16000	24000
Available head	Pa	570	350	200	150
Standard Pump					
Pump type		Screw pump			
Quantity	no.	1	1	1	1
Nominal/max fluid flow rate	l/min	135	160	190	230
Nominal available head	bar	10	10	10	10
Storage tank capacity (optional)					
Storage tank capacity (optional)	l	200			
IN/OUT liquid connections	inch	1 1/2"			
Net weight (approximate)***	kg	580	600	600	600
Width - Depth - Height	mm	945 - 1795 - 2138			
Sound pressure level**	dB (A)	75	75	75	78

* Data relates to operation under the following conditions: inlet/outlet oil temp. 40/30°C, ISO VG 32 oil, ambient temperature 32°C.

** Sound pressure level, measured in a free parallelepiped field at a distance of 1 m, per ISO 3746.

*** Weight includes pallets and packaging (where provided for), with refrigerant charge, without storage tank and axial fans.

The electrical data refer to cos φ = 0.8.

Correction factors for calculating the cooling power												
Oil outlet temperature	Fo	°C	20	25	30	35						
		factor	0.75	0.83	1	1.20						
Ambient Temperature	Fa	°C				15	20	25	32	35	40	45
		factor				1.27	1.2	1.13	1	0.95	0.86	0.80
Oil type	Ft	type	ISO VG 10		ISO VG 22		ISO VG 32		ISO VG 46		ISO VG 68	
		factor	1.15		1.1		1		0.9		0.82	
Cooling power = Nominal cooling power x Fo x Fa x Ft												

TCI

Immersion coil chillers

The new TCI range of chillers from nVent, featuring immersion coil evaporators, is nVent's answer to any oil/water cooling requirements for industrial applications.



TCI56÷91 Size 2

Immersion coil chillers

COOLING CAPACITY

6000 - 7100 - 8100 - 9650 - 9200 - 11000 W



STRUCTURE

In powder-coated steel sheet, RAL 7035 textured finish. Easily removed panels

COMPRESSOR

Hermetic SCROLL compressor, cooled by the refrigerant, complete with thermal cut-out.

REFRIGERATION CIRCUIT

Complete with charging port, drier filter, thermostatic valve, high- and low-pressure pressure switch, refrigerant gas.

EVAPORATOR

Dual concentric coil in AISI 304 stainless steel. Resin-covered stainless-steel regulation sensor, IP67 rated.

AIR CONDENSER

Finned high-efficiency copper tube condensing coil, complete with safety grille.

AXIAL FAN

Axial fan, complete with thermal cut-out and safety grille. On request, centrifugal fan for air expulsion ducting

ELECTRICAL PANEL

With main disconnect switch, fused motor protection.

MANAGEMENT AND CONTROL

The TX110 control unit manages the chiller's operation, providing warnings including high/low temperature alarms and a general serious fault alarm, with the display indicating if this refers to the refrigeration circuit or protection of the immersion coils. An on-off contact allows the machine to be switched on remotely. Control disconnect switch for switching on the machine.

PAINT/COATING

Standard colour: RAL 7035 textured.

MAIN OPTIONS

FP - Polyurethane air filter

TD - Differential fluid temperature management (two sensors)

BGP - Hot gas bypass for ± 0.5 K temperature precision

- Agitator for fluid movement
- Non-standard paint/coating
- Satin AISI 304 stainless steel framework
- Design of higher cooling powers with dedicated framework
- Centrifugal fans for condensation air ducting

DIMENSIONS

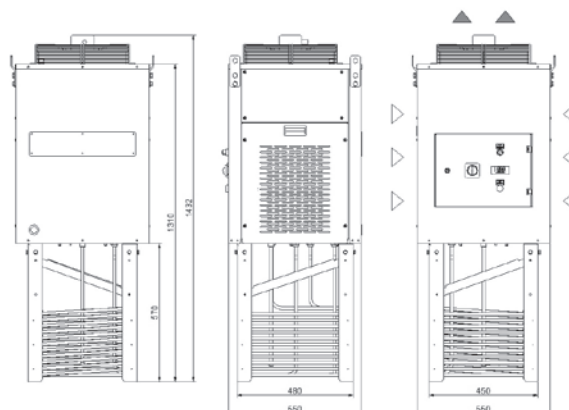



Model		TCI56		TCI70		TCI91	
		50 Hz	60 Hz	50 Hz	60 Hz	50 Hz	60 Hz
Rated Cooling Capacity*	W	6000	7100	8100	9650	9200	11000
Ambient temperature operating limits	°C	-5 - +45					
Settable fluid temperature range	°C	+15 / +25 water or emulsion max 5 cSt -40°C +20 / +30 mineral oil 32 cSt -40°C					
Temperature precision	K	+/- 1					
Refrigerant gas	HFC	R134a					
Minimum fluid flow rate (emulsion/oil)	l/min	40 - 60					
Minimum volume in tank (emulsion/oil)	l.	60 - 100					
Power supply							
Supply voltage	V ph Hz	400/460 V (+/-10%) 3 ph 50/60 Hz					
Secondary supply voltage	V	230 V - 24 V AC					
Digital thermostat		TX110					
Compressor							
Compressor type		Scroll					
Quantity - Number of circuits	no.	1 - 1					
Max. power draw	kW	3	3.6	3.5	4.2	4.1	4.9
Max. current draw	A	5.6	6.7	6.4	7.7	7.1	8.5
Axial Fan							
Fan type		Axial					
Quantity	no.	1					
Air flow rate	m³/h	2000					
Max. power draw	kW	0.18	0.25	0.18	0.25	0.18	0.25
Max. current draw	A	0.81	1.1	0.81	1.1	0.81	1.1
Dimensions							
Net weight (approximate)***	kg	145		147		150	
Width - Depth - Height	mm	550 - 550 - 1432					
Sound pressure level**	dB (A)	57		57		57	
IP rating	IP	44					

* Data relates to operation under the following conditions: Ambient temperature 32°C.

** Sound pressure level at 50 Hz, measured in a free hemispherical field at a distance of 1 m from the machine and 1.5 metres from the ground, per ISO 3746.

*** Weight includes pallets and packaging (where provided for), with refrigerant charge and axial fans.

The electrical data refer to $\cos \varphi = 0.8$.

Correction factors for calculating the cooling power								
Ambient Temperature	Emulsion	Oil	Cooling capacity					
			32	15	20	4620	5467	6237
	20	25	5460	6461	7371	8782	8372	10010
	25	30	6000	7100	8100	9650	9200	11000
37	15	20	4332	5126	5848	6967	6642	7942
	20	25	5187	6138	7002	8342	7953	9510
	25	30	5700	6745	7695	9168	8740	10450
42	15	20	4066	4811	5489	6539	6234	7454
	20	25	4805	5686	6486	7728	7367	8809
	25	30	5280	6248	7128	8492	8096	9680

TCIA2÷A7 Size 3

Immersion coil chillers

COOLING CAPACITY

12300 - 14600 - 16400 - 19400 - 17800 - 20450 W



STRUCTURE

In powder-coated steel sheet, RAL 7035 textured finish. Easily removed panels

COMPRESSOR

Hermetic SCROLL compressor, cooled by the refrigerant, complete with thermal cut-out.

REFRIGERATION CIRCUIT

Complete with charging port, drier filter, thermostatic valve, high- and low-pressure pressure switch, refrigerant gas.

EVAPORATOR

Dual concentric coil in AISI 304 stainless steel. Resin-covered stainless-steel regulation sensor, IP67 rated.

AIR CONDENSER

Finned high-efficiency copper tube condensing coil, complete with safety grille.

AXIAL FAN

Axial fan, complete with thermal cut-out and safety grille. On request, centrifugal fan for air expulsion ducting

ELECTRICAL PANEL

With main disconnect switch, fused motor protection.

MANAGEMENT AND CONTROL

The TX110 control unit manages the chiller's operation, providing warnings including high/low temperature alarms and a general serious fault alarm, with the display indicating if this refers to the refrigeration circuit or protection of the immersion coils. An on-off contact allows the machine to be switched on remotely. Control disconnect switch for switching on the machine.

PAINT/COATING

Standard colour: RAL 7035 textured.

MAIN OPTIONS

FP - Polyurethane air filter

TD - Differential fluid temperature management (two sensors)

BGP - Hot gas bypass for +/-0.5 K temperature precision

- Agitator for fluid movement
- Non-standard paint/coating
- Satin AISI 304 stainless steel framework
- Design of higher cooling powers with dedicated framework
- Centrifugal fans for condensation air ducting

DIMENSIONS

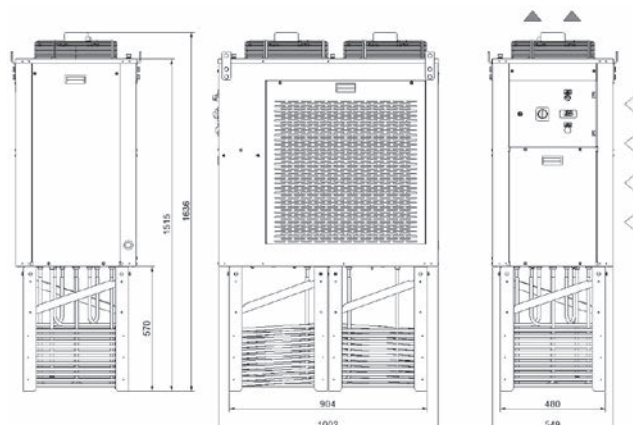



Model		TCIA2		TCIA4		TCIA7	
		50 Hz	60 Hz	50 Hz	60 Hz	50 Hz	60 Hz
Rated Cooling Capacity*	W	12300	14600	16400	19400	17800	20450
Ambient temperature operating limits	°C	-5 - +45					
Settable fluid temperature range	°C	+15 / +25 water or emulsion max 5 cSt -40°C +20 / +30 mineral oil 32 cSt -40°C					
Temperature precision	K	+/- 1					
Refrigerant gas	HFC	R410A					
Minimum fluid flow rate (emulsion/oil)	l/min	80 - 120					
Minimum volume in tank (emulsion/oil)	l.	150 - 250					
Power supply							
Supply voltage	V ph Hz	400/460 V (+/-10%) 3 ph 50/60 Hz					
Secondary supply voltage	V	230 V - 24 V AC					
Digital thermostat		TX110					
Compressor							
Compressor type		Scroll					
Quantity - Number of circuits	no.	1 - 1					
Max. power draw	kW	3.1	3.5	4.0	4.3	4.1	4.7
Max. current draw	A	9.8	9.6	12.1	11.8	12.5	12.1
Axial Fan							
Fan type		Axial					
Quantity	no.	2					
Air flow rate	m³/h	4300					
Max. power draw	kW	0.4	0.55	0.4	0.55	0.4	0.55
Max. current draw	A	1.7	2.2	1.7	2.2	1.7	2.2
Dimensions							
Net weight (approximate)***	kg	215		215		215	
Width - Depth - Height	mm	549 - 1002 - 1636					
Sound pressure level**	dB (A)	60		60		60	
IP rating	IP	44					

* Data relates to operation under the following conditions: Ambient temperature 32°C.

** Sound pressure level at 50 Hz, measured in a free hemispherical field at a distance of 1 m from the machine and 1.5 metres from the ground, per ISO 3746.

*** Weight includes pallets and packaging (where provided for), with refrigerant charge and axial fans.

The electrical data refer to $\cos \varphi = 0.8$.

Correction factors for calculating the cooling power								
Ambient Temperature	Emulsion	Oil	Cooling capacity					
			32	15	20	9471	11242	12628
	20	25	11193	13286	14924	17909	16198	18610
	25	30	12300	14600	16400	19400	17800	20450
37	15	20	8881	10541	11841	14209	12852	14765
	20	25	10633	12622	14178	17014	15388	17679
	25	30	11685	13870	15580	18696	16910	19428
42	15	20	8334	9893	11113	13336	12061	13857
	20	25	9850	11692	13133	15760	14254	16376
	25	30	10824	12848	14432	17318	15664	17996

TAU

Industrial chillers for contaminated or dirty fluids

Thanks to the tube bundle heat exchanger, the TAU range allows dirty fluids to be cooled while guaranteeing the highest levels of performance and the lowest maintenance costs



C-NEXT TAU24-37 Size 1

Industrial chillers for contaminated or dirty fluids

COOLING CAPACITY

2300/2700 - 3600/4200 W



STRUCTURE

In powder-coated steel sheet, RAL 7035 textured finish. Easily removed panels.

COMPRESSOR

Hermetic reciprocating compressor, cooled by the refrigerant, complete with thermal cut-out.

REFRIGERATION CIRCUIT

Complete with charging port, drier filter, expansion valve, high-pressure pressure switch, R134a refrigerant.

EVAPORATOR

Tube bundle heat exchanger (allows for inspection).

AIR CONDENSER

Microchannel condensing coil, complete with safety grille.

AXIAL FAN

Axial fan, complete with thermal cut-out and safety grille.

LIQUID CIRCUIT

Non-ferrous liquid circuit composed of peripheral electric pump, or, 0–10 bar pressure gauge, protective flow switch, regulation sensor.

ELECTRICAL PANEL

With main disconnect switch, fused motor protection.

MANAGEMENT AND CONTROL

The TX110 control unit manages the chiller's operation, providing warnings including high/low temperature alarms and a general serious fault alarm, with the display indicating if this refers to the refrigeration or liquid circuit. An on-off contact allows the machine to be switched on remotely (pump included). Control disconnect switch for switching on the machine.

PAINT/COATING

Standard colour: RAL 7035 textured.

MAIN OPTIONS

- BA - Mechanical bypass valve protecting the pump
- LTA - Operation at low ambient temperatures
- FP - Polyurethane air filter
- RU - Castors
- TD - Differential fluid temperature management (two sensors)
- BGC - Hot gas bypass for ± 1 K temperature precision
- BGP - Hot gas bypass for ± 0.5 K temperature precision
- UL1 - Electrical panel and UL-certified components
- HIGH-pressure pump version "H" - 5 bar, version "R" - 7 bar.
- Outdoor installation options

DIMENSIONS

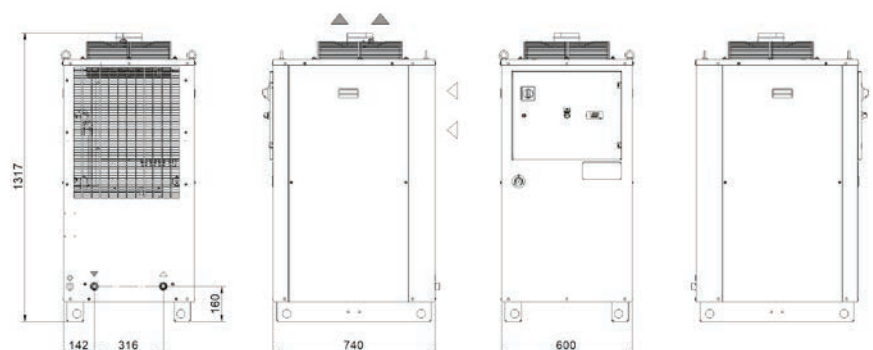



Model		TAU24		TAU37	
		50 Hz	60 Hz	50 Hz	60 Hz
Rated Cooling Capacity*	W	2300	2700	3600	4200
Ambient temperature operating limits	°C	+15 - +45			
Settable fluid temperature range	°C	+25 - +40			
Fluid type		Emulsion 90% water - 10% oil			
Temperature precision	K	+/-2			
Refrigerant gas	HFC	R134a			
Power supply					
Supply voltage	V ph Hz	230 V (+/-10%) 1 ph 50 or 60 Hz			
Secondary supply voltage	V	230 V AC			
Digital thermostat		TX110			
Compressor					
Compressor type		Reciprocating			
Quantity - Number of circuits	no.	1 - 1			
Nominal power draw	kW	0.84	1.04	1.16	1.5
Axial Fan					
Fan type		Axial			
Quantity	no.	1			
Air flow rate	m³/h	1250 - 1650		1550 - 2050	
Centrifugal Fan (optional)					
Fan type		Centrifugal			
Quantity	no.	1			
Air flow rate	m³/h	2100 - 2400		2100 - 2400	
Available head	Pa	250			
Standard Pump					
Pump type		Centrifugal			
Quantity	no.	1			
Nominal/max fluid flow rate	l/min	5		8	
Nominal available head	bar	3	3	3	3
Storage tank capacity	l	50			
IN/OUT liquid connections	inch	3/4"			
Net weight (approximate)**	kg	151		153	
Width - Depth - Height	mm	600 - 740 - 1317			
Sound pressure level**	dB (A)	57	60	57	60

* Data relates to operation under the following conditions: inlet/outlet temp. 37/30°C, 90% water - 10% oil emulsion, ambient temperature 32°C.

** Sound pressure level, measured in a free parallelepiped field at a distance of 1 m, per ISO 3746.

*** Weight includes pallets and packaging (where provided for), with refrigerant charge, storage tank empty, axial fans.

The electrical data refer to cos φ = 0.8.

Correction factors for calculating the cooling power												
90% water - 10% ISO VG 32 oil emulsion outlet temperature	Fo	°C	20	25	30	35						
		factor	0.59	0.77	1	1.22						
Ambient Temperature	Fa	°C				15	20	25	32	32	40	45
		factor				1.26	1.2	1.11	1	0.95	0.87	0.8
Oil type	Ft	%	water		90% water - 10% ISO VG 32 oil		70% water - 30% ISO VG 32 oil		40% water - 60% ISO VG 32 oil		100% ISO VG 32	
		factor	1.05		1		0.9		0.74		0.53	
Cooling Power = Nominal Cooling Power x Fo x Fa x Ft												

C-NEXT TAU29÷A0 Size 1 Three-phase

Industrial chillers for contaminated or dirty fluids

COOLING CAPACITY

2900 - 3600 - 4550 - 6000 - 8100 - 9550 - 10900 W



STRUCTURE

In powder-coated steel sheet, RAL 7035 textured finish. Easily removed panels.

COMPRESSOR

Hermetic reciprocating compressor, cooled by the refrigerant, complete with thermal cut-out.

REFRIGERATION CIRCUIT

Complete with charging port, drier filter, expansion valve, high-pressure pressure switch, R134a refrigerant.

EVAPORATOR

Tube bundle heat exchanger (allows for inspection).

AIR CONDENSER

Microchannel condensing coil, complete with safety grille.

AXIAL FAN

Axial fan, complete with thermal cut-out and safety grille.

LIQUID CIRCUIT

Non-ferrous liquid circuit composed of peripheral electric pump, storage tank made of plastic material complete with integrated visual level indicator, 0–10 bar pressure gauge, protective flow switch, regulation sensor.

ELECTRICAL PANEL

With main disconnect switch, fused motor protection.

MANAGEMENT AND CONTROL

The TX110 control unit manages the chiller's operation, providing warnings including high/low temperature alarms and a general serious fault alarm, with the display indicating if this refers to the refrigeration or liquid circuit. An on-off contact allows the machine to be switched on remotely (pump included). Control disconnect switch for switching on the machine.

PAINT/COATING

Standard colour: RAL 7035 textured.

MAIN OPTIONS

BA - Mechanical bypass valve protecting the pump

LTA - Operation at low ambient temperatures

FP - Polyurethane air filter

RU - Castors

TD - Differential fluid temperature management (two sensors)

BGC - Hot gas bypass for +/-1 K temperature precision

BGP - Hot gas bypass for +/-0.5 K temperature precision

UL1 - Electrical panel and UL-certified components

- HIGH-pressure pump version "H" - 5 bar, version "R" - 7 bar.
- Outdoor installation options

DIMENSIONS

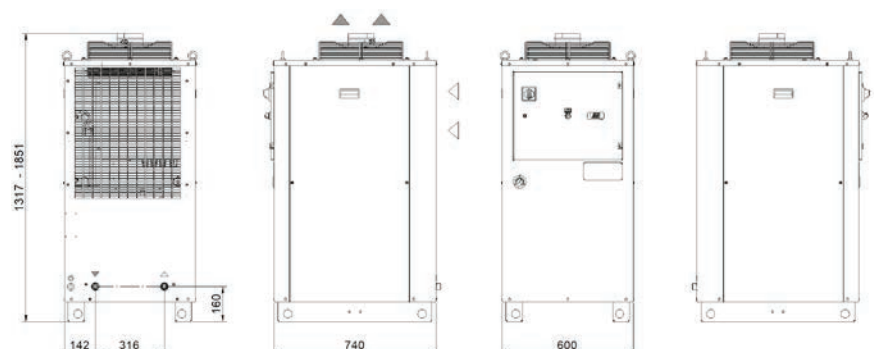



Model		TAU29	TAU37	TAU46	TAU57	TAU76	TAU93	TAUA0	
Rated Cooling Capacity*	W	2900	3600	4550	6000	8100	9550	10900	
Ambient temperature operating limits	°C	+15 - +45							
Settable fluid temperature range	°C	+25 - +40							
Fluid type		Emulsion 90% water - 10% oil							
Temperature precision	K	+/-2							
Refrigerant gas	HFC	R134a							
Power supply									
Supply voltage	V ph Hz	400 V (+/-10%) 3 ph 50 Hz							
Secondary supply voltage	V	230 V AC							
Digital thermostat		TX110							
Compressor									
Compressor type		Reciprocating				Scroll			
Quantity - Number of circuits	no.	1 - 1							
Nominal power draw	kW	0.78	1.16	1.42	2.42	2.21	2.60	2.73	
Axial Fan									
Fan type		Axial							
Quantity	no.	1							
Air flow rate	m³/h	1550	1550	1800	1800	3150	3350	4400	
Centrifugal Fan (optional)									
Fan type		Centrifugal							
Quantity	no.	1							
Air flow rate	m³/h	2100 - 2400	2100 - 2400	2100 - 2400	2100 - 2400	2100 - 2400	2100 - 2400	2100 - 2400	
Available head	Pa	250							
Standard Pump									
Pump type		Centrifugal							
Quantity	no.	1							
Nominal/max fluid flow rate	l/min	6.5	8	10	13.5	18	21	24	
Nominal available head	bar	3	2.9	2.8	2.7	3.1	3	2.8	
Storage tank									
Storage tank capacity	l	50							
IN/OUT liquid connections	inch	3/4"							
Net weight (approximate)***	kg	151	153	155	160	165	170	175	
Width - Depth	mm	600 - 740							
Height	mm	1317				1851			
Sound pressure level**	dB (A)	57	57	57	57	57	57	57	

* Data relates to operation under the following conditions: inlet/outlet temp. 37/30°C, 90% water - 10% oil emulsion, ambient temperature 32°C.

** Sound pressure level, measured in a free parallelepiped field at a distance of 1 m, per ISO 3746.

*** Weight includes pallets and packaging (where provided for), with refrigerant charge, storage tank empty, axial fans.

The electrical data refer to cos φ = 0.8.

Correction factors for calculating the cooling power												
90% water - 10% ISO VG 32 oil emulsion outlet temperature	Fo	°C	20	25	30	35						
		factor	0.59	0.77	1	1.22						
Ambient Temperature	Fa	°C				15	20	25	32	32	40	45
		factor				1.26	1.2	1.11	1	0.95	0.87	0.8
Oil type	Ft	%	water		90% water - 10% ISO VG 32 oil	70% water - 30% ISO VG 32 oil	40% water - 60% ISO VG 32 oil		100% ISO VG 32			
		factor	1.05		1	0.9	0.74		0.53			
Cooling Power = Nominal Cooling Power x Fo x Fa x Ft												



SAW

Water-air heat exchangers

The most simple and cost-effective system for cooling of fluids in industrial processes through the ambient air.



SAW50

Water-air heat exchangers

COOLING CAPACITY

5000-5650 W



STRUCTURE

in polyester powder-coated steel sheet.

AXIAL FAN

Aluminium axial fan, diameter 250 mm.

LIQUID CIRCUIT

Liquid circuit composed entirely of non-ferrous material in contact with the liquid to prevent contamination. Brass electric pump with 3 bar available head with thermal cut-out. Storage tank, complete with filling.

Protective water flow switch.

COOLING COIL

Dual finned aluminium cooling coil with copper tubes.

MANAGEMENT AND CONTROL

Power supply cable: 1.5 m.

PAINT/COATING

Standard colour: RAL 7035 textured.

MAIN OPTIONS

LE - Electrical level indicator

FP - Polyurethane air filter

TR - Digital regulation thermostat, temperature display complete with NTC sensor

RU - Castors

AV - Vibration damper supports

Others on customer request

DIMENSIONS

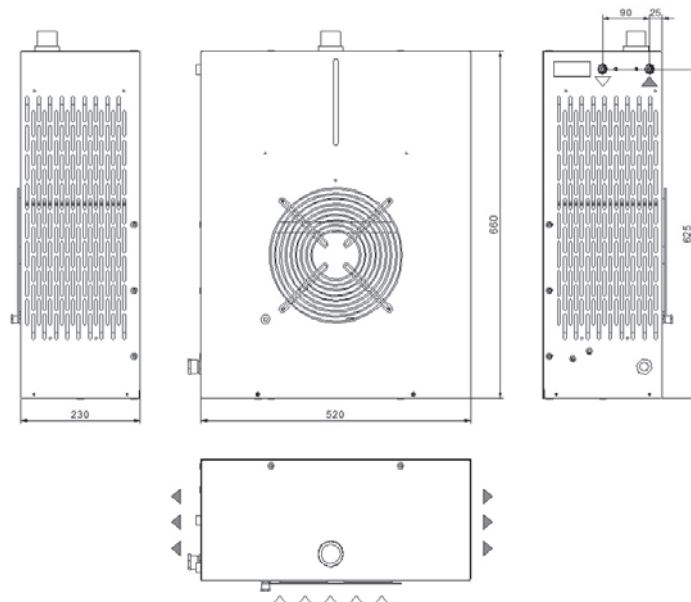

Model		SAW50	
		50 Hz	60 Hz
Rated Cooling Capacity*	W	5000	5650
Max. ambient operating temp.	°C	50	
Fluid type		Water	
Power supply			
Supply voltage	V ph Hz	230 V (+/-10%) 1 ph 50/60 Hz	
Axial Fan			
Fan type		Axial	
Quantity	no.	1 x d.250 mm	
Air flow rate	m³/h	1500 - 1725	
Standard Pump			
Pump type		Peripheral	
Quantity	no.	1	
Nominal/max fluid flow rate	l/min	10.0 - 16.0	13.5 - 18.0
Nominal available head	bar	2.8	
Max. power draw	kW	0.65	0.70
Max. current draw	A	3.4	4.6
Storage tank capacity			
Storage tank capacity	l	5	
Net weight (approximate)***	kg	19	
Width - Depth - Height	mm	520 - 230 - 660	
Sound pressure level**	dB (A)	38	
IP rating	IP	34	

* Data relates to operation under the following conditions: outlet temp. 50°C water, ambient temperature 35°C.

** Sound pressure level at 50 Hz, measured in a free hemispherical field at a distance of 1 m from the machine and 1.5 metres from the ground, per ISO 3746.

*** Weights with storage tank empty and all packaging removed.

The electrical data refer to cos φ = 0.8.

Correction factors for calculating the cooling power												
T water- T ambient ΔT	Fw	°C	5	10	15	20	25	30	35	40		
		factor	0.38	0.67	1.00	1.30	1.67	1.91	2.32	2.55		
Percentage glycol by weight	Fg	%	0	10	15	20	25	30	35	40		
		factor	1.00	0.97	0.96	0.95	0.94	0.93	0.91	0.90		
Cooling power = Nominal cooling power x Fo x Fa x Ft												

SAWA0

Water-air heat exchangers

COOLING CAPACITY

10000 W



STRUCTURE

In polyester powder-coated steel sheet.

AXIAL FAN

Axial fan in aluminium.

LIQUID CIRCUIT

Liquid circuit composed entirely of non-ferrous material in contact with the liquid to prevent contamination. Stainless-steel electric pump with available head of over 3.5 bar, with thermal cut-out. Storage tank, complete with filling.

COOLING COIL

Microchannel heat exchanger.

MANAGEMENT AND CONTROL

Power supply cable: 1.5 m.

PAINT/COATING

Standard colour: RAL 7035 textured.

MAIN OPTIONS

LE - Electrical level indicator

FP - Polyurethane air filter

TR - Digital regulation thermostat, temperature display complete with NTC sensor

RU - Castors

AV - Vibration damper supports

Others on customer request

DIMENSIONS

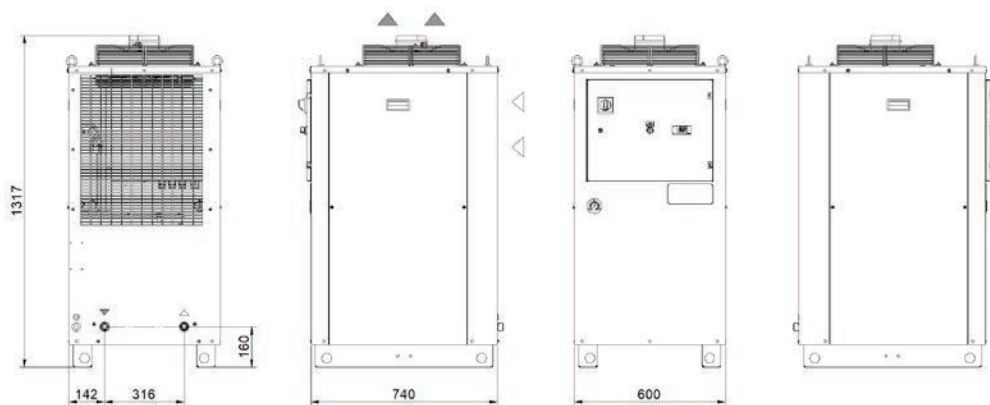

Model		SAWA0	
Rated Cooling Capacity*	W	10000	
Max. ambient operating temp.	°C	50	
Fluid type		Water	
Power supply			
Supply voltage	V ph Hz	230 V (+/-10%) 1 ph 50 Hz	
Axial Fan			
Fan type		Axial	
Quantity	no.	1	
Air flow rate	m³/h	2500 - 2850	
Standard Pump			
Pump type		Peripheral	
Quantity	no.	1	
Nominal/max fluid flow rate	l/min	32 - 80	
Nominal available head	bar	3.5	
Max. power draw	kW	1.5	
Max. current draw	A	6.5	
Storage tank capacity			
Storage tank capacity	l	50	
IN/OUT liquid connections	inch	3/4"	
Net weight (approximate)***	kg	90	
Width - Depth - Height	mm	600 - 740 - 1317	
Sound pressure level**	dB (A)	38	
IP rating	IP	44	

* Data relates to operation under the following conditions: outlet temp. 50°C water, ambient temperature 35°C.

** Sound pressure level, measured in a free hemispherical field at a distance of 1 m from the machine and 1.5 metres from the ground, per ISO 3746.

*** Weights with storage tank empty and all packaging removed.

The electrical data refer to $\cos \phi = 0.8$.

Correction factors for calculating the cooling power												
T water- T ambient ΔT	Fw	°C		5	10	15	20	25	30	35	40	
		factor		0.38	0.67	1.00	1.30	1.67	1.91	2.32	2.55	
Percentage glycol by weight	Fg	%		0	10	15	20	25	30	35	40	
		factor		1.00	0.97	0.96	0.95	0.94	0.93	0.91	0.90	
Cooling power = Nominal cooling power x Fo x Fa x Ft												

Chiller Fluid

Chemical additives for industrial cooling circuits

INTRODUCTION

nVent, thanks to its experience in manufacturing industrial cooling systems, has developed multiple liquid solutions for industrial systems to be used with or without mixing with water. Whenever water is used as the heat transfer medium in circuits, the use of these liquid solutions offers complete protection of the liquid system, also guaranteeing that the heat transfer capacity is maintained. These products have been designed to limit the onset of problems such as corrosion, the formation of deposits and scale, bacteriological phenomena, reduction in performance, increases in maintenance costs, unexpected stoppages and reduction of the average lifespan of the systems. The phenomenon which causes the greatest number of problems in circuits is CORROSION. The water present in the systems tends to form scale deposits and bacterial slime, and above all encourages corrosion caused by the metal being attacked by the oxygen it contains. The use of high-purity water (demineralised, RO purified and in some cases softened) prevents the formation of scale but significantly increases corrosion issues.

The main causes of corrosion are:

OXIDATION of the metals due to the oxygen dissolved in the water;

ACID produced by the breakdown of glycol over time.

nVent therefore decided to develop multiple solutions to meet customer requirements in order to prevent damage to industrial systems, particularly closed circuits (at atmospheric and other pressures).

WARNING: For detailed information on the toxicity and other safety factors relating to any type of fluid, refer to the MSDS provided by nVent.



FLUID 903-TX

Product code: C15001209-25 kg can - C15002650-10 kg can

This is a liquid solution based on 93% ethylene glycol with the addition of inhibitors and biocides. The product is compatible with all the most common metals (iron, steel, copper and its alloys, aluminium and its alloys), as well as plastic and rubber. Designed to protect liquid circuits in industrial machines, machine tools and all those systems where the recirculation of cold or hot water in multi-metal circuits is necessary. It is formulated with substances which provide three key actions to protect the system:

ANTIFREEZE ACTION: prevents the formation of ice at temperatures around zero;

CORROSION INHIBITION: prevents corrosion by forming a protective film on metal surfaces.

BIOCIDAL ACTION: inhibits growth of fungi, moulds and bacteria, preventing slime build-up.

Do not mix with softened, demineralised and RO purified water.



FLUID 903-TX-MIXED

Product code: C15001218-25 kg can

This is a liquid solution based on 30% ethylene glycol with the addition of inhibitors and biocides, and mixed with 70% water. Retains the same chemical characteristics as 903-TX.



FLUID BIOCIDE-ALGICIDE FLUID

Product code: C15003950-25 kg can - C15003930-1 kg can

This is a biocide formulation based on isothiazolinone with an excellent algicidal and biomass dispersion action. It is used to control biological pollution in open recirculated or similar cooling circuits. It penetrates the biological masses thanks to its effective dispersive action, guaranteeing the best possible cleaning of the heat exchange surfaces. This liquid, as well as having a powerful biocidal and algicidal effect, also has low levels of toxicity. The use of this liquid is particularly recommended for softened, demineralised and RO purified water (laser applications).



FLUID CORROSION INHIBITOR

Product code: C15003949-25 kg can - C15003929-1 kg can

This is a highly ecological formulation which prevents corrosion in closed recirculated hot and cold water circuits. The presence of a strong inorganic anodic inhibitor, which is ecologically compatible, together with organic inhibitors and polymer dispersants, provides excellent protection from corrosion for ferrous and cupric metals and alloys and excellent cleaning of the heat exchange surfaces, preventing the formation of any kind of deposits. Also compatible with non-metallic components.



FLUID FOOD

Product code: C15004334-25 kg can

This is a multifunctional diathermic fluid based on FDA approved inhibited mono ethylene glycol. Recommended for use as a diathermic fluid whenever accidental food contact is possible. Not suitable for use as a direct food component or additive. It is compatible with most other diathermic fluids based on mono ethylene glycol. Exclusive use of this product is recommended for optimum protection against corrosion. It must be mixed only with low hardness distilled water.

It protects metals and alloys used in systems against all forms of corrosion. The combination of low toxicity and FDA approved ingredients with a high level of corrosion protection makes this product unique on the market. Competing products often provide insufficient protection for aluminium and copper. Given the frequent use of copper in the food industry, the excellent protection that FLUID FOOD provides for it makes it a particularly suitable product.





Our powerful portfolio of brands:

CADDY ERICO HOFFMAN ILSCO SCHROFF TRACHTE