

Guide Rail Standard Type, PC, 160 mm, 2 mm Groove Width, Red, 10 Pieces

CATALOG NUMBER

24568-361

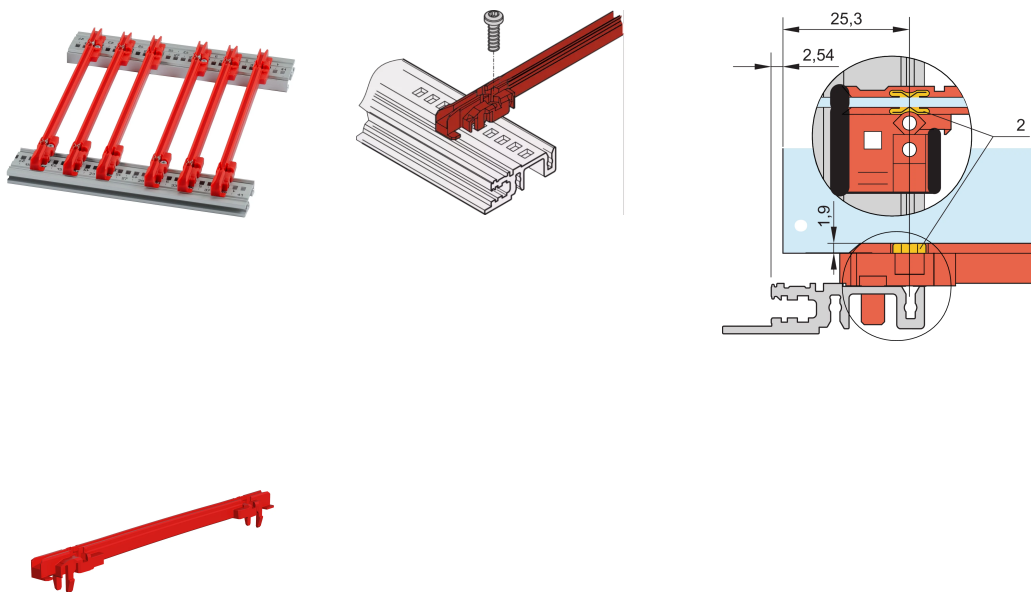

New generation of accessory type guide rails for PCBs or plug-in units. Forms a reliable interface between the subrack mechanics and the sub-assemblies.

CERTIFICATIONS



FEATURES

NEW generation Standard type plastic guide rails for reliable retention of PCBs or plug-in units

Significantly increased stability, due to a optimized design and high quality material (PC)

Improved fire safety properties, fulfills EN 45545-2 requirement sets R22, R23 and R24 with HL3

"Halogen-Free", according to IEC 61249-2-21

Can be clipped into horizontal rails (Al extrusion) or into 1.5 mm thick plates

Can be bolted to the horizontal rails Type H and R for higher shock and vibration requirements

Optional ESD clip for an conductive contact between PCB and horizontal rail available

Storage temperature: from -40 °C ... 130 °C

PRODUCT ATTRIBUTES

Color: Red

Package Quantity: 10

Board Depth: 160mm

Groove Width: 2

Complies With: EN 45545-2

Material: Fiber-Reinforced Plastic

Product Family: EuropacPRO; RatiopacPRO; RatiopacPRO AIR; CompacPRO; PropacPRO; MultipacPRO; Inpac

Product Type: Guide Rail

Type: Standard

Works With: Subracks; Cases; 19" Chassis; Systems

ADDITIONAL PRODUCT DETAILS

Please take into consideration that deliveries may be carried out in the stated SPQs (SPQ, e.g. 5 pieces, 10 pieces, 50 pieces, etc.). Differing order quantities (e.g. 2 pieces) may be changed to the next possible delivery quantity = Standard Pack Quantity.

WARNING

nVent products shall be installed and used only as indicated in nVent's product instruction sheets and training materials. Instruction sheets are available at www.nvent.com and from your nVent customer service representative. Improper installation, misuse, misapplication or other failure to completely follow nVent's instructions and warnings may cause product malfunction, property damage, serious bodily injury and death and/or void your warranty.

North America

All locations

+1.763.422.2661

Chat with us:

nvent.com/schroff

Europe

Straubenhardt, Germany

+49.7082.794.0

Betschdorf, France

+33.3.88.90.64.90

Warsaw, Poland

+48.22.209.98.35

Assago, Italy

+39.02.932.7141

Chat with us:

nvent.com/schroff

Asia

Shanghai, China

+86.21.2412.6943

Qingdao, China

+86.532.8771.6101

Singapore

+65.6768.5800

Shin-Yokohama, Japan

+81.45.476.0271

Chat with us:

nvent.com/schroff

Middle East & India

Dubai, United Arab

Emirates

+971.4.378.1700

Bangalore, India

+91.80.6715.2001

Istanbul, Turkey

+90.216.250.7374

Chat with us:

nvent.com/schroff



Our powerful portfolio of brands:

CADDY

ERICO

HOFFMAN

ILSCO

SCHROFF

TRACHTE