



We connect and protect

nVent Wind Energy Solutions

Grounding and bonding, power connections, surge and lightning protection for wind power generation.



CADDY ERICO ERIFLEX

nVent.com



Table of Contents

Foundation Grounding and Design	4
Introduction.....	6
Blade Components	7
Inside the Nacelle solutions.....	8
Inside tower solutions	10
Foundation Grounding and Construction.....	12
Custom Solutions and Training.....	14

We connect and protect a more sustainable & electrified world

nVent provides solutions that connect and protect critical utility assets, making a significant contribution to the power grid's safety, long-term reliability and modernization efforts.

Long-Term Reliability

As a company

- Trusted, reliable utility industry supplier partner for more than a century.

With respect to products

- Products offer a long service life and are less likely to fail prematurely, exposing critical assets to damage.
- Reliability in the industry has earned nVent spec position with utility companies.

Safety

Our products are critical to the safety of people, utility staff and the public.

- Products contain many features that ensure they function safely in operation.
- nVent products meet and exceed the highest quality and performance standards.

Critical Protection for Valuable Assets

We help protect valuable, mission-critical assets from costly damage.

- Protection for critical assets that are expensive to replace.
- Prevent downtime (electrical outages) – the worst-case scenario for utility companies.
- Innovative features; to add additional layer of protection against several risks, including theft, lightning, and surge.

Expertise and Experience in the Wind Energy Industry

We are positioned to meet the future needs of the power grid, including new infrastructure areas (energy storage, mini-substations) and the significant integration of sensitive mission-critical monitoring and communications systems.

Foundation Grounding and Design

Bonding, Power Connections, Surge Protection and Lightning Protection

nVent ERIFLEX Low Voltage power connections



Power Blocks



Grounding and MJB Braids



Flexibar Advanced



Low-Voltage Insulators

nVent CADDY Cable management support



Cable Ladder



Wire basket tray



Multi-Function C-Clamp



Hammer-On Flange Clip, Side Mount

Enclosures



A wide range of nVent HOFFMAN enclosures ready to install for the gearbox and base

nVent LENTON Mechanical construction supports



Bolt Couplers



Terminator Rebar End Anchors



Standard Couplers and Position Couplers

nVent ERICO lightning protection



Blade Lightning Protection Components and Assemblies



Lightning Strike Counter



Lightning Registration Card

nVent ERICO surge protection



Power and Control Surge Protection



Foundation grounding and construction

nVent ERICO Cadweld Connections



Cable to Rebar



Cable to Cable



Cable to Cable



Cable to Ground Rod

Cable to Rebar Connections



nVent ERICO Ground Enhancement Material (GEM)



nVent offers a holistic range of products for foundation grounding and construction, bonding, power connections, surge protection and lightning protection for the wind energy industry. In addition to our extensive product offering, our engineers and designers are ready to provide design assistance for your facilities worldwide.

Energy Storage
(Wind Hybrid)

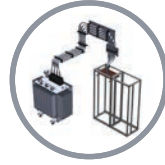

nVent ERIFLEX FlexBus System connection between electrical equipment & transformer



nVent ERIFLEX Flexible Busbar (Flexibar Advanced), & nVent ERIFLEX IBSB Advanced; complete solutions for flexible flat conductors that vary in length & can also be customized solution

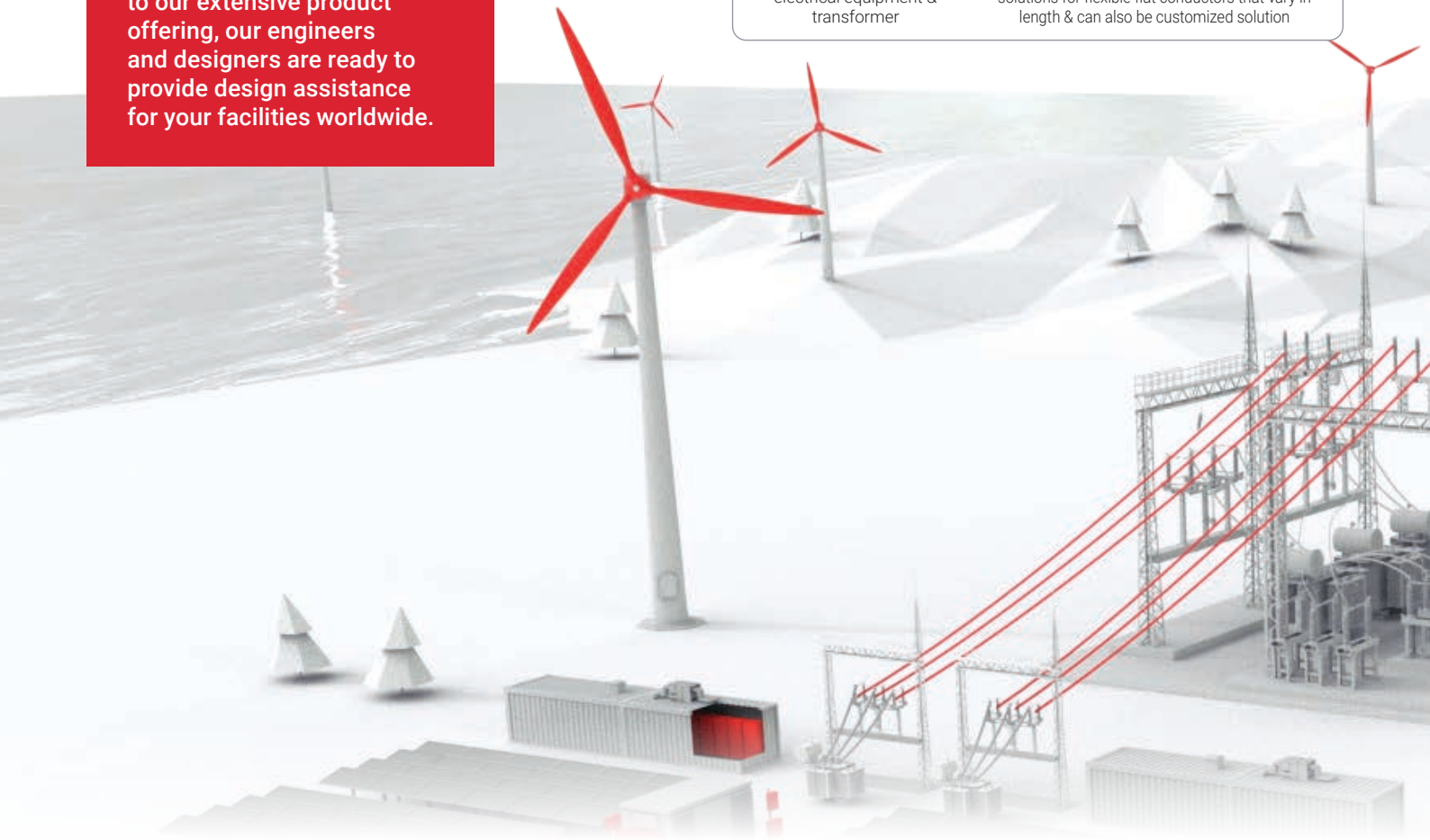

nVent ERICO Foundation grounding and construction

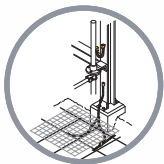

Prefabricated Mesh for Switch Shaft and Operating Handle Grounding

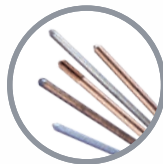

Ground Rods Copper-bonded Steel Galvanized Steel Stainless Steel



Fence and Gate Jumper Assemblies

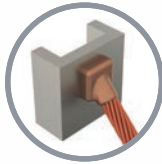

nVent ERICO Cadweld

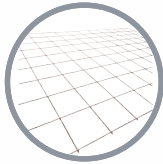

Grounding Mesh

Power connection

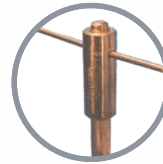

nVent ERICO Hammerlock and Ground Rod

Lightning protection



nVent ERICO complete range of active and passive Systems

nVent ERICO Surge Protection

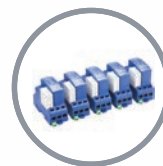

Power and Control Surge Protection for SCADA and Power Connections



Universal Transient Barrier (UTB)

Introduction

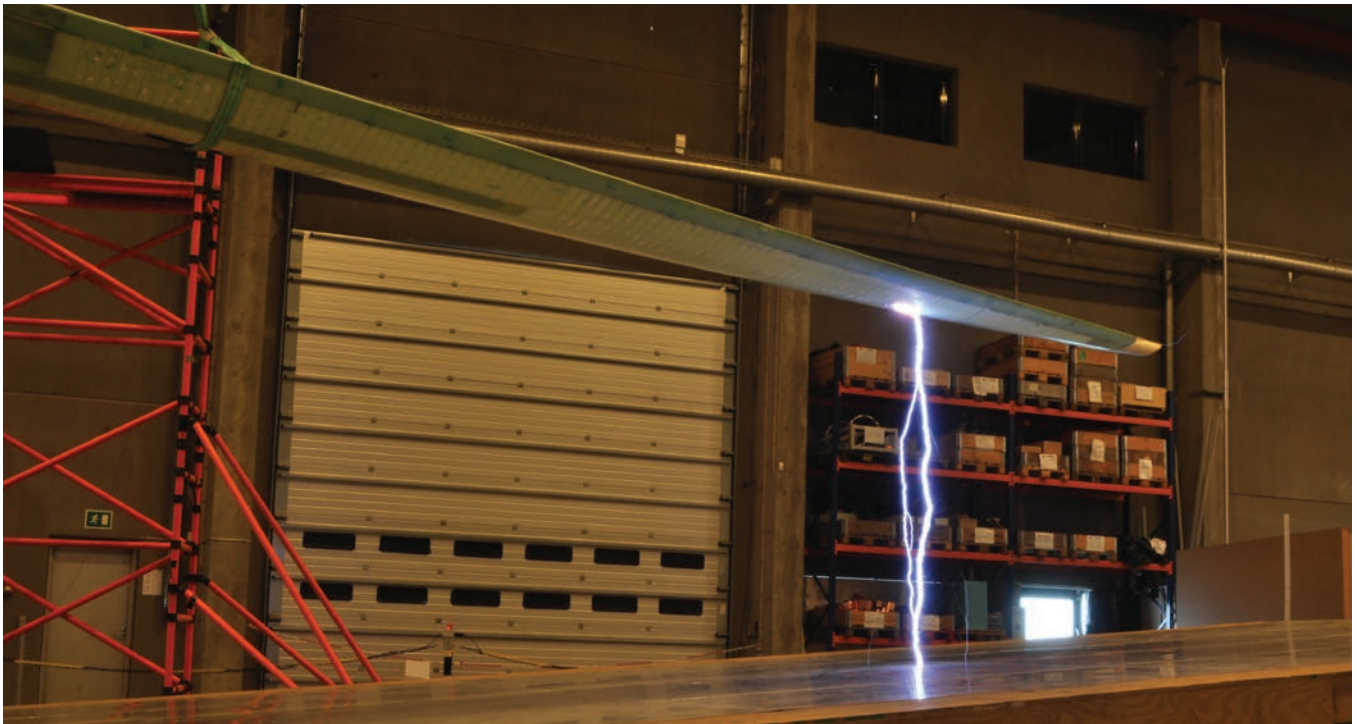

LIGHTNING PROTECTION

nVent offers a wide range of products for lightning protection for the blades, nacelle and tower.

At the outset, our lightning protection assemblies have been installed on thousands of wind turbine blades worldwide. Components cover a range of nVent ERICO products, including receptors, nVent ERICO Cadweld Exothermic Connections, conductors, and lightning event counters/registration systems.

Furthermore, nVent provides tower lightning protection products in addition to assemblies for blades and nacelles. Among them are grounding braids, insulators, conductors, nVent ERIFLEX Flexibar Advanced, and copper busbars.

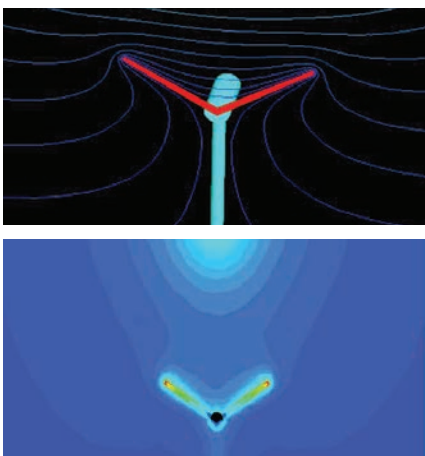

FOUNDATION GROUNDING AND CONSTRUCTION

Grounding products include nVent ERICO Cadweld Exothermic Connections, rebar clamps, ground/earth testers, and nVent ERICO Ground Enhancement Material (GEM) (compliant with IEC standards). Among the foundation construction products are bolt couplers, nVent LENTON Terminator rebar end anchors, and standard couplers.

SURGE PROTECTION

As part of an integrated electrical protection plan, nVent offers a complete line of surge protection devices.

POWER CONNECTIONS

Various splice blocks, power shunts, distribution blocks, nVent ERIFLEX Flexibar Advanced, and busbar supports can be used for power distribution in the nacelle, tower, and power hut.

A comprehensive range of nVent ERIFLEX products, including grounding braids, insulators, nVent ERIFLEX Flexibar Advanced, power blocks, and conductors, can be found within the nacelle to help protect the electrical components.

As a global manufacturer, nVent combines years of experience and expertise in grounding and bonding, lightning protection, low-voltage power distribution, and reinforced concrete construction to provide comprehensive solutions to the wind energy industry.

Whether your wind energy project is onshore, offshore, or hybrid; nVent offers a full range of solutions, including facility electrical protection products, low-voltage power distribution products and concrete reinforcement products.



Download our Whitepaper on Wind Turbine Blade Lightning Protection

Blade Components

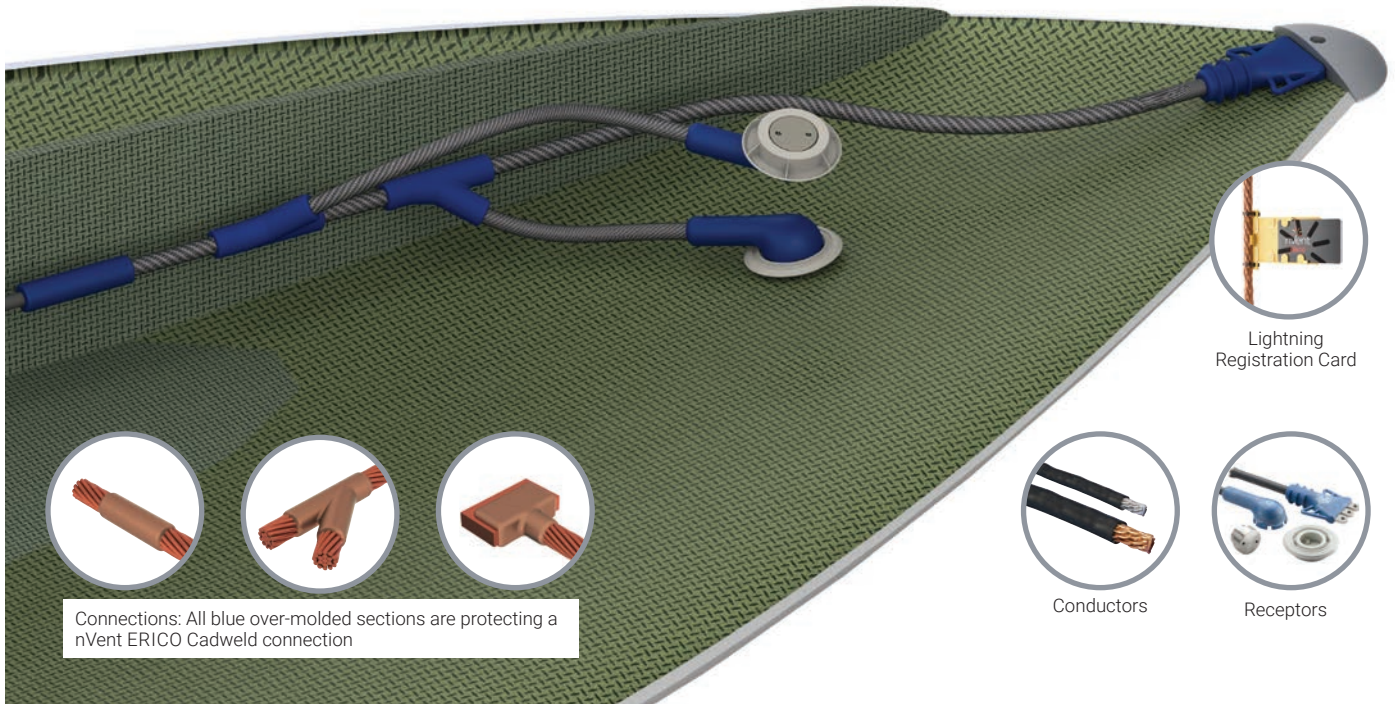

CONDUCTORS

Lightning conductors are designed and manufactured to meet specific criteria to provide effective and reliable conduction:

- Low inductance and surge impedance per unit length
- The capability of current carrying to withstand lightning's thermal and mechanical effects without degradation
- A high level of resistance to environmental effects and mechanical fatigue

Conductors offered include:

- Aluminum, copper and stainless steel
- Insulated and non-insulated
- Solid and woven conductors in both flat and rounded configurations

RECEPTORS

The lightning receptors designed by nVent take advantage of nVent's experience as a world leader in the design of strike termination devices. Among the most important factors are:

- Materials and manufacturing processes for blades
- Ease of installation and insulation requirements for receptors
- Attachment method to lightning protection conductor

- Attracting the lightning strike to a preferred attachment point
- Field serviceability

CONNECTIONS

Various types of lightning protection connections can be used for blades, from nVent ERICO Cadweld welded connections to mechanically bolted connections. Considerations include:

- Lightning protection conductor material
- Resistance to vibration and corrosion
- Material impedance
- National/international standard requirements
- Costs and benefits

LIGHTNING REGISTRATION CARDS & EVENT COUNTERS

nVent provides the ability to collect and monitor data for the analysis of lightning strikes. The lightning registration system is ideal for use on land and offshore turbines.

Lightning event counters provide the ability to collect data for the analysis of lightning strikes. The devices are ideal for both land-based and offshore turbines.

The lightning protection assembly kits manufactured by nVent meet and exceed OEM specifications. Additionally, nVent works closely with OEMs to tailor the level of assurance they need to mitigate risk. As a result, component designs are refined to improve reliability and enhance lightning protection.



Download our whitepaper for wind turbine lightning protection

Inside the Nacelle solutions

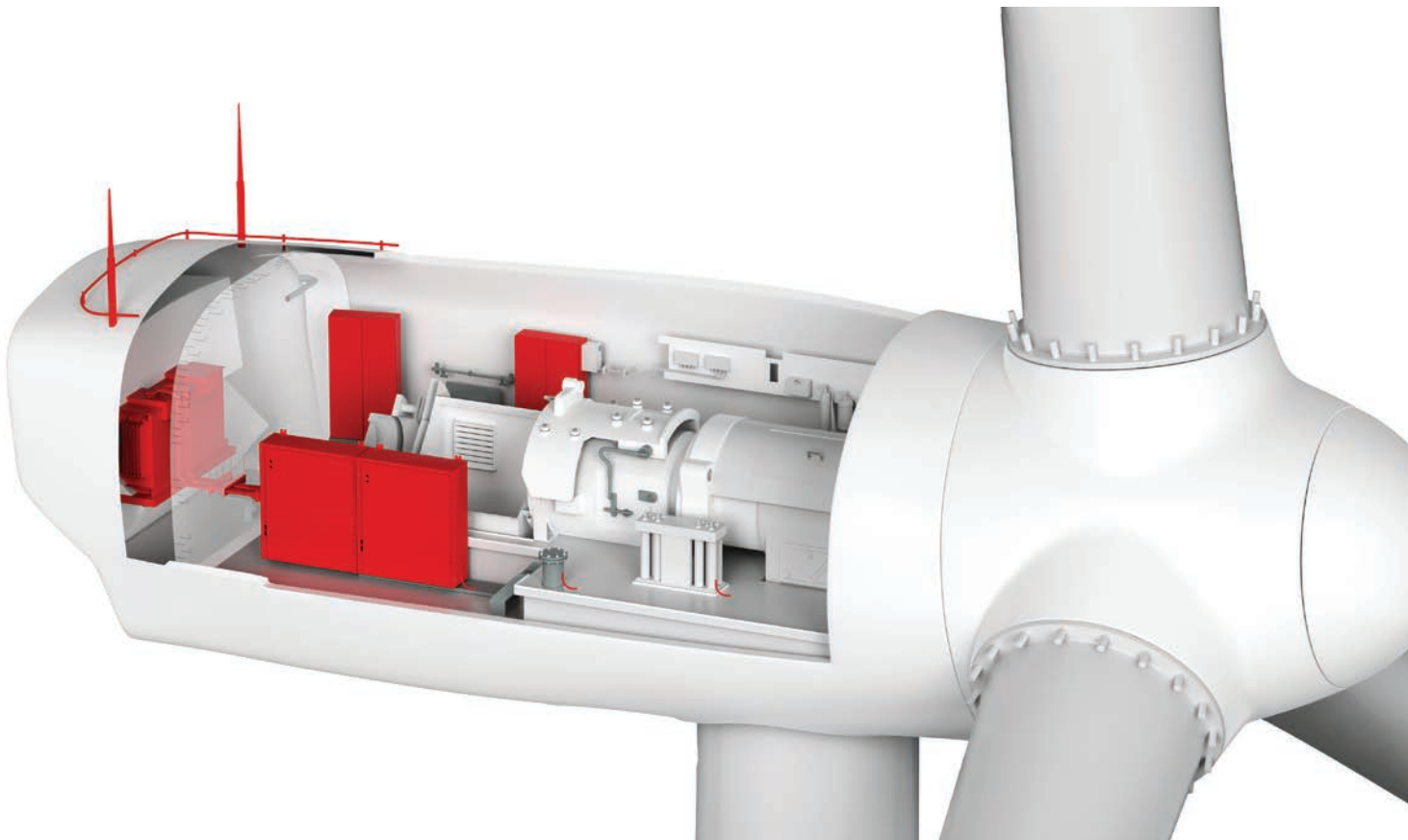

GROUNDING BRAIDS

Grounding braids consist of tinned, electrolytic, woven copper wire. Each braid has solid hole-punched ends for easy connection. Grounding braids are the first cost-effective alternative to grounding cables with crimped lugs.

Braids can be used for grounding and bonding power connections. Because of their low contact resistance, they are particularly effective at reducing EMC problems.

FLEXIBAR ADVANCED

Thanks to its unique and safe Advanced insulation, nVent ERIFLEX Flexibar Advanced is an effective alternative and lugs to improve power density within your nacelle, tower, and to using cables power hut. Compared to conventional transformers, it provides savings of up to 30% in space and weight (improving the power density).

Flexibar Advanced reduces the number of power connections required and

improves the reliability of power connections by eliminating compression lugs. Additionally, it extends the power density within the nacelle, tower and power hut

CONDUCTORS

Designed and manufactured to meet specific criteria for effective and reliable conduction, lightning conductors should have:

- Low inductance per unit length and low surge impedance
- Current-carrying capability to withstand, without degradation, the thermal and mechanical effects of lightning
- Resistance to environmental effects and mechanical fatigue

Conductors offered include:

- Aluminum, copper and stainless steel
- Insulated and non-insulated
- Solid and woven conductors in both flat and rounded configurations

POWER AND DISTRIBUTION BLOCKS

A complete power block range are the entry point for incoming power generated by the wind turbine, carried to the inverter.

SURGE PROTECTION

DIN rail mounted components

- UL and IEC Listed
- Enhanced temporary over voltage (TOV) withstand capability
- Retaining clip ensures enhanced vibration and shock resistance performance

LOW-VOLTAGE INSULATORS

nVent ERIFLEX offers a complete range of low-voltage insulators.

- Manufactured of rugged, polyamide, halogen-free nylon material, which is reinforced with glass fiber
- Low-voltage insulators, from 15 mm to 100 mm height, for indoor use
- Very high resistance to leakage current



Grounding Braids



Flexibar Advanced



Low Voltage Insulators

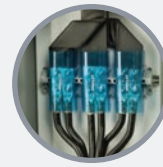

Power Blocks

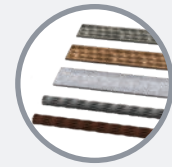

Conductors



Lightning Registration Cards



Transient Discriminating Panel Surge Protection



Isolated Lightning Protection Conductor



Air Terminals

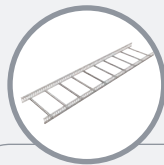

Cable Ladder

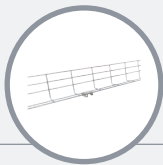

Wire Basket Tray



Multi-Function C-Clamp



Hammer-On Flange Clip, Side Mount

Cable management support

- Great stability of electrical and mechanical parameters
- Meets the requirements of UL 94-V0 for self-extinguishing materials
- Working temperature -40°C to $+130^{\circ}\text{C}$
- UL Recognized

LIGHTNING PROTECTION

Insulated down conductor provides a low impedance insulated path past critical equipment.

nVent also provides a lightning event counter with remote monitoring, which is installed on the down conductor to record the number of lightning strikes.

CABLE MANAGEMENT SUPPORT

As a leader in cable management support solutions, nVent CADDY offers a wide range of products that include wire basket trays, perforated cable trays and cable ladder systems, as well as vertical cable support and the various structural attachments required to run cables from the bottom of the tower to the nacelle and powering different equipment along the way.

Lightning strikes can have devastating effects on electrical components which are housed within a nacelle, which is why nVent offers a full lineup of nVent ERIFLEX low-voltage products. Products include:

- Power blocks designed to provide a safe entry point for incoming power generated by the wind turbine
- Grounding braids for any grounding and bonding power connection

- nVent ERIFLEX Flexibar Advanced to help improve power density within the nacelle, tower and power hut
- Conductors to withstand the electromechanical effects of lightning
- Low-voltage insulators to promote stability of electrical and mechanical parameters



Inside tower solutions



GROUNDING BRAIDS

Grounding braids consist of tinned, electrolytic, woven copper wire. Each braid has solid hole-punched ends for easy connection. Grounding braids are the first cost-effective alternative to grounding cables with crimped lugs.

Grounding braids can be used for any grounding and bonding power connection. Because of their low contact resistance, they are particularly adapted to decrease EMC problems.

nVent can provide (Made-to-Order) Customized Engineering Solutions to your drawing specifications. Copper braids can be made to custom lengths, widths, thicknesses and hole patterns.

COPPER BUSBAR

nVent offers a variety of electrolytic copper bars – plain, punched or threaded. Busbars/connectors are also available.

- Threaded Busbars
- Punched and Plain Busbars
- Busbar Connectors

FLEXIBLE POWER CONNECTIONS

Flexibar Advanced is an effective alternative to cables and lugs to help improve power density within the nacelle, tower and power hut. This flexible insulated busbar offers space and weight savings of up to 70% (improving power density).

Furthermore; nVent provides FlexBus system which is an innovative and patented connection solution between two pieces of electrical equipment (such as a transformer, switchboard or generator). This unique concept brings an alternative solution to the market providing faster installation and reducing total installation cost. FlexBus Advanced maintains a high level of reliability and creates an easy and customizable connection on-site without additional design study, specific specialized workforce or expensive tools. FlexBus Advanced is a complete low-voltage power connection system designed for multiple applications that include connections from transformer to switchgear, interconnection between

transformers, connections from or to generator, switchgear interconnection and machine connection. Advanced Technology insulation sets the standard in the electrical market, with all products being low smoke, halogen-free, flame retardant (LSHFFR) and high temperature.



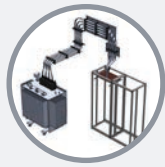

nVent ERIFLEX
FleXbus System



Grounding Braids

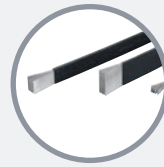

Flexibar Advanced

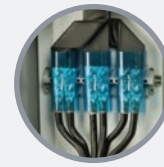

Power Blocks



Braids



Copper Busbars



Electrical Earth Bar

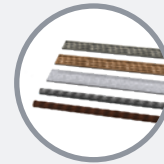

Conductors

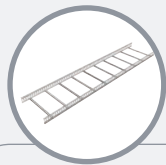

Cable Ladder

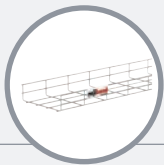

Wire basket tray



Multi-Function
C-Clamp



Hammer-On Flange Clip,
Side Mount

Cable management support

CONDUCTORS

Designed and manufactured to meet specific criteria for effective and reliable conduction, lightning conductors should have:

- Low inductance per unit length and low surge impedance
- Current-carrying capability to withstand, without degradation, the thermal and mechanical effects of lightning
- Resistance to environmental effects and mechanical fatigue

Conductors offered include:

- Aluminum, copper and stainless steel
- Insulated and non-insulated
- Solid and woven conductors in both flat and rounded configurations

POWER BLOCKS

High conductivity tinned copper blocks provide a good solution to interconnect two elements of the tower. They can be mounted directly inside the tower or pre-assembled in junction panels.

CABLE MANAGEMENT SUPPORT

As a leader in cable management support solutions, nVent CADDY offers a wide range of products that include wire basket trays, perforated cable trays and cable ladder systems, as well as vertical cable support and the various structural attachments required to run cables from the bottom of the tower to the nacelle and powering different equipment along the way.

The wide range of Fasteners backed by our extensive application expertise and customer service will help contractors overcome the challenges they can face while installing cables in wind turbines.

It is also important to note that nVent CADDY Armour Coating, applied on spring steel fasteners, carries a 10-year warranty against corrosion. This proprietary coating includes at least 1,000 hours of resistance against red rust when tested per the ASTM B117 / EN ISO 9227 salt spray tests.

A variety of products are available from nVent that enable wind turbine towers to be protected from lightning strikes and to distribute power efficiently. Designed to meet the current IEC®, NFPA® or a proprietary design method, lightning protection and power distribution systems from nVent are ideal for use with the three styles of tower design:

- Tubular steel towers
- Precast concrete towers
- Lattice towers

Foundation Grounding and Construction

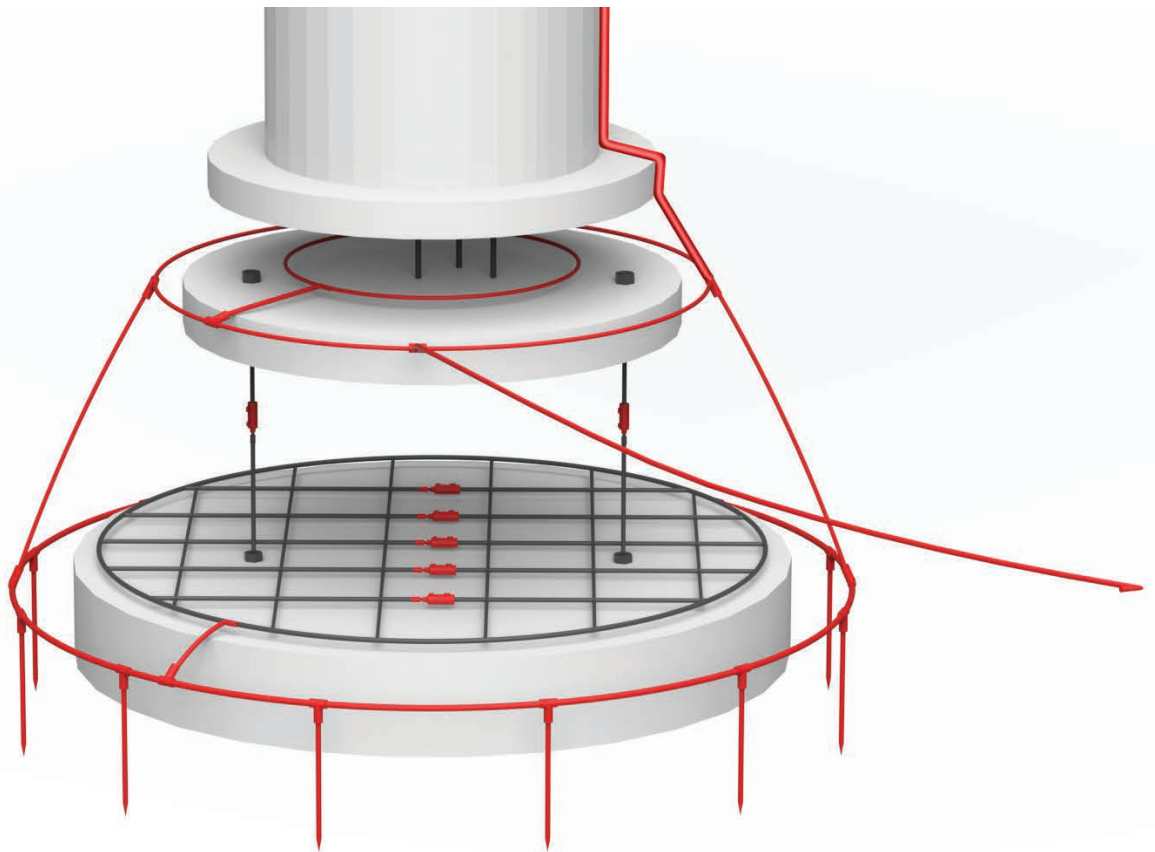

Construction

BOLT COUPLERS

Bolt couplers, part of the nVent LENTON line of concrete products, provide a full strength joint between a reinforcing bar and a standard parallel thread bolt. Both the S4 and S5 couplers are for use in North America and provide continuity between reinforcing bar and imperial UN or UNC all-thread rod or bolts. The S13 couplers provide continuity between reinforcing bar and ISO 965 metric all-thread rod and bolts. The bolt couplers are typically used to tie a pedestal base to the foundation and to anchor miscellaneous equipment to the foundation.

TERMINATOR

The Terminator is an over-sized end anchor that is secured to the end of a length of reinforcing steel, creating anchorage within the concrete. Terminator replaces hooked bars and provides anchorage, and also eases congestion.

STANDARD COUPLERS AND POSITION COUPLERS

Standard couplers are designed to splice the same diameter bars where one bar is free to move and can be rotated. Position couplers are designed to splice two curved, bent or straight bars when neither bar can be rotated.

Grounding

GROUND RODS

Copper-bonded steel ground rods exceed the requirements of ANSI®/UL and IEC. They are also highly corrosion resistant and provide at least a 30-year service life in most soils.

MECHANICAL CONNECTORS

The durable RC70/RC100 rebar clamps provide two connection points to rebar in the wind turbine grounding foundation and meet the NEC® standard requirement for bonding to rebar.

GROUND ENHANCEMENT MATERIAL (GEM)

GEM is a low-resistance carbon concrete that improves grounding effectiveness in areas of poor conductivity. GEM is ideal for wind turbine foundations where limited space makes adequate grounding difficult by conventional methods.

GROUND/EARTH TESTERS

nVent offers a range of ground/earth testers that are lightweight and portable for ease of use in the field. The ground testers are ideal for determining soil resistivity prior to designing the wind turbine foundation ground system and for testing the final resistance of the ground system after installation.

CONDUCTORS

Below grade, nVent ERICO Cu-Bond Round Conductors are ideal as earthing and bonding conductors where copper theft may occur. The conductor can be used as an interconnecting grounding conductor between wind towers or as a grounding grid at the base of a wind tower.

CONSTRUCTION

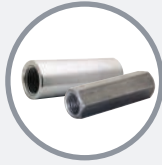

Bolt Couplers



Terminator

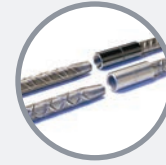

Standard Couplers & Position Couplers

GROUNDING



Ground Rods



Mechanical Connectors



Ground Enhancement Material (GEM)



Cadweld



Ground/Earth Testers

EXOTHERMICALLY WELDED CONNECTIONS

The Cadweld molecular bonding process is superior in performance to any known mechanical or compression-type surface-to-surface contact connector. By virtue of the molecular bond, Cadweld connections provide current-carrying (fusing) capacity equal to that of the conductor and will not deteriorate with age.

Cadweld connections are IEC® certified, UL Listed and satisfy IEEE® Standard (Standard for Permanent Connections Used in Substation Grounding).

For more information, please check: www.cadweld.com

Site location is critical to capture the wind and often involves areas of high soil resistivity. The increasing height of newer wind turbines enhances the threat of lightning strikes. Proper design and integrity of a grounding grid facilitates long-term safety and operation of any wind turbine site during both lightning and fault current events.

Wind turbine grounding system design has to meet three main criteria:

- Satisfy the step-and-touch potential requirements regarding the safety of personnel
- Provide sufficient ground reference potential to assure proper functionality of electrical equipment
- Effectively dissipate the lightning energy

The application engineering team at nVent can analyze and provide grounding system design assistance for tower and power substation grounding using the latest grounding design software. nVent also offers an extensive line of grounding products to meet your specific foundation grounding needs.



Custom Solutions and Training



ENGINEERING AND DESIGN SERVICES

By leveraging nVent solutions and using our engineering expertise, designers and manufacturers can reduce their total installation costs while improving safety and reliability and meeting stringent customer requirements.

Let our in-house experts assist by supporting your system design, providing technical and configuration advice or quoting for complete low-voltage power solutions.

To assist with assembly manufacturing, our nVent team provides:



Design support



Our proprietary interactive panel software



Early involvement



Training and assistance during installation

ELECTRICAL ENGINEERING LAB

nVent has invested in state-of-the-art equipment and expanded the in-house Engineering Electrical Lab to meet evolving regional trends and needs. By increasing capability, nVent can support major development and commercial opportunities. With the lab, nVent can:

- Support the testing of new applications using nVent ERICO brand products
- Participate in the UL Client Test Data Program
- Conduct competitive product testing
- Enhance the internal development of innovative products
- Support key commercial opportunities
- Reduce time to market
- Test and evaluate to IEC standards

TRAINING

nVent application engineers and researchers have decades of domain expertise and continue to develop new products for improved performance and installation efficiency for the ever-evolving wind power industry. We are trusted to deliver cost-effective, long-term solutions through turn-key, rapid-response engineering, design and integration services for the unique demands of the wind energy industry.

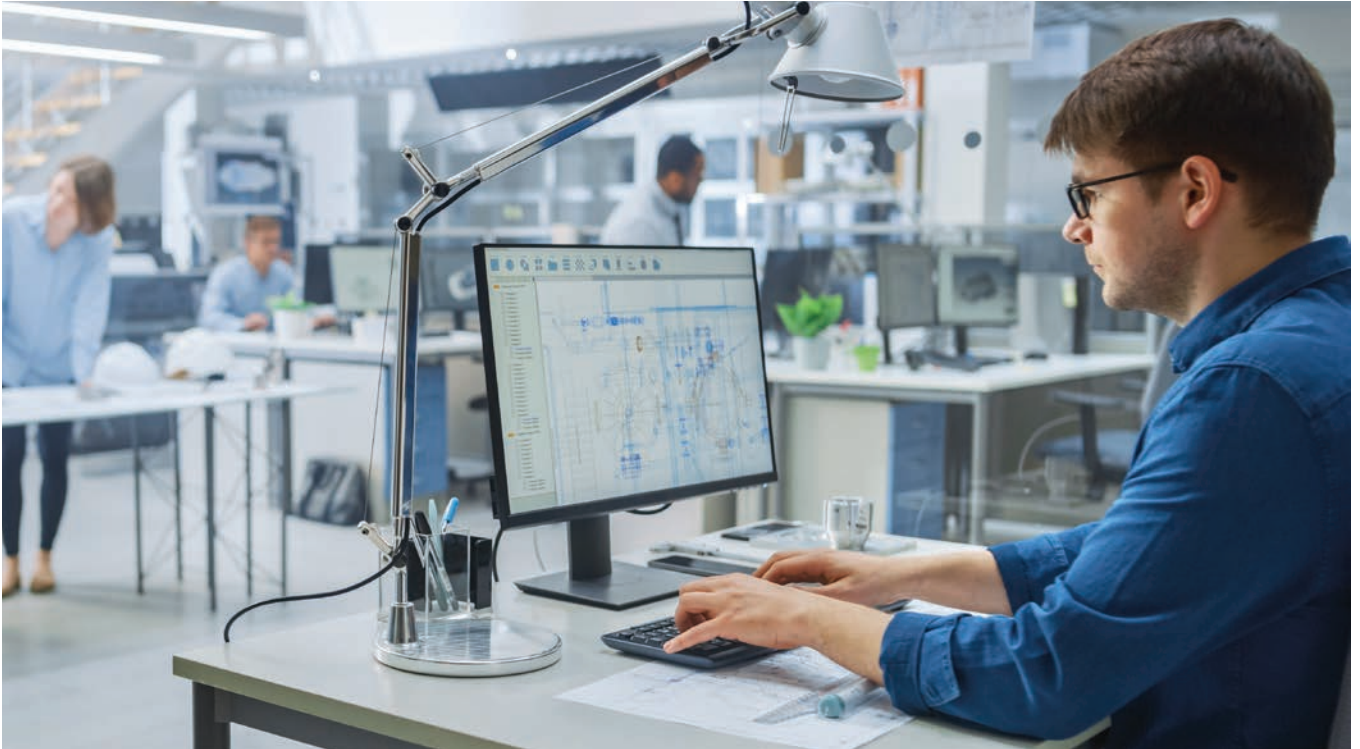

NVENT SPECIALIZES IN:

- Custom design and packaging of lightning protection assemblies for wind turbine blades
- Grounding and bonding applications of the nacelle and tower
- Design and manufacture of lightning protection down conductors and connection systems
- Computer grounding layouts and analysis for the foundation

nVent provides extensive training and consultative services to OEMs, engineers and contractors on our product capabilities and installation techniques to help ensure optimum performance.

CUSTOMIZED ENGINEERING SOLUTIONS

nVent engineering experts can support your system design, provide technical and configuration advice, and help quote your complete grounding, lightning protection or surge solution.

- Design-to-order for your specific job to meet project requirements and code requirements
- Custom product configurations
- Design services

SYSTEM DESIGN ASSISTANCE

nVent experts can assist engineers and designers with selecting the right solutions for their designs and projects.

Lightning protection system design assistance

- Assist in designing and selecting the right lightning protection system for your project
- Import and export 2D and 3D drawings directly into your design submittal
- Add product details in 2D and 3D based on your custom-tailored design

Grounding and bonding system design

- Assist in designing and selecting the right grounding and bonding components for your project
- Import and export 2D drawings directly into your design submittal
- Add product details in 2D based on your custom-tailored design

Resources and Services



Find more resources for understanding wind energy infrastructure electrical and fastening requirements at [nVent.com](https://www.nVent.com).



Interactive Virtual World

See nVent products in action by using our interactive customer maps.



Utility Virtual World



nVent Virtual World



Wind Virtual world

View more about the nVent Wind energy product offering on nVent.com.



Wind Energy Products



Training

nVent Training Center virtual access allowing your teams to learn the complete nVent brand portfolio at their convenience.



[Browse the Catalog](#)



Resources

Follow nVent EFS on social media to stay up-to-date on new products and more.



[Follow Now](#)



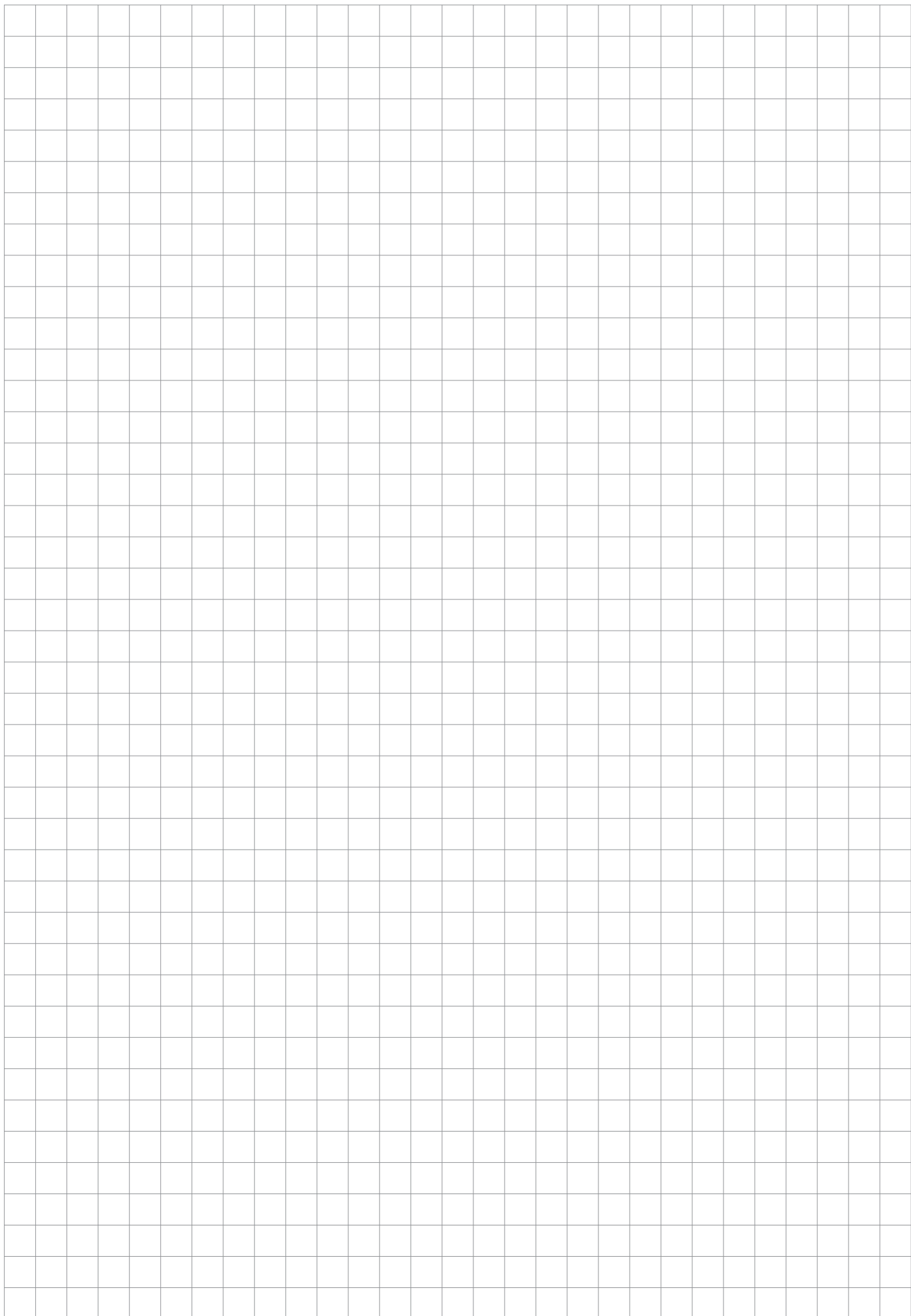

nVent.com



Our powerful portfolio of brands:

CADDY

ERICO

HOFFMAN

ILSCO

RAYCHEM

SCHROFF