

Insertor/Extractor Handle Type IEL, Grey Lever, Black Button, Top, 10 Pieces

CATALOG NUMBER

20817-692

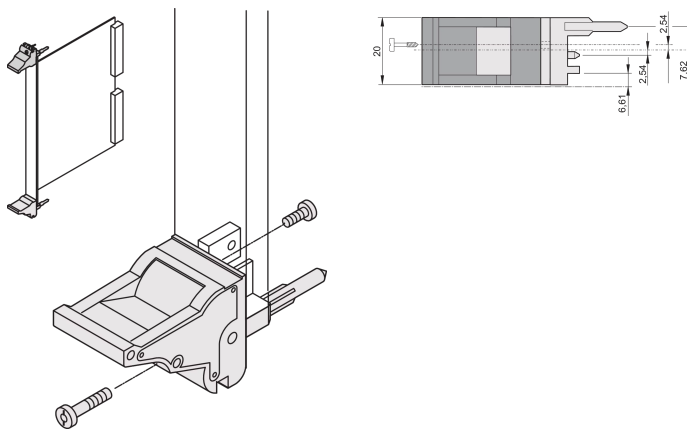

The insertor/extractor handle, type IEL in accordance with IEEE 1101.10. 0,1" offset Two of these handles can overcome a single lever force of 700 N (per pair).

CERTIFICATIONS

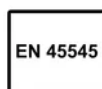

FEATURES

Suitable for insertion and extraction forces up to 700 N (per pair)

In accordance with IEEE 1101.10 and IEC 60297-3-102

A microswitch can be mounted

0.1" offset is used for PSUs with SMD Plus

PRODUCT ATTRIBUTES

Package Quantity: 10

Handle Type: IEL; Top Front

Flammability Rating: UL® 94V-0

Color: Grey

Complies With: EN 45545-2

Material: Polycarbonate

Product Type: Handle

Type: Inserter/Extractor, 0.1" Offset

Works With: Front Panels

ADDITIONAL PRODUCT DETAILS

Please order Coding pegs and Microswitch separately.

DIAGRAMS

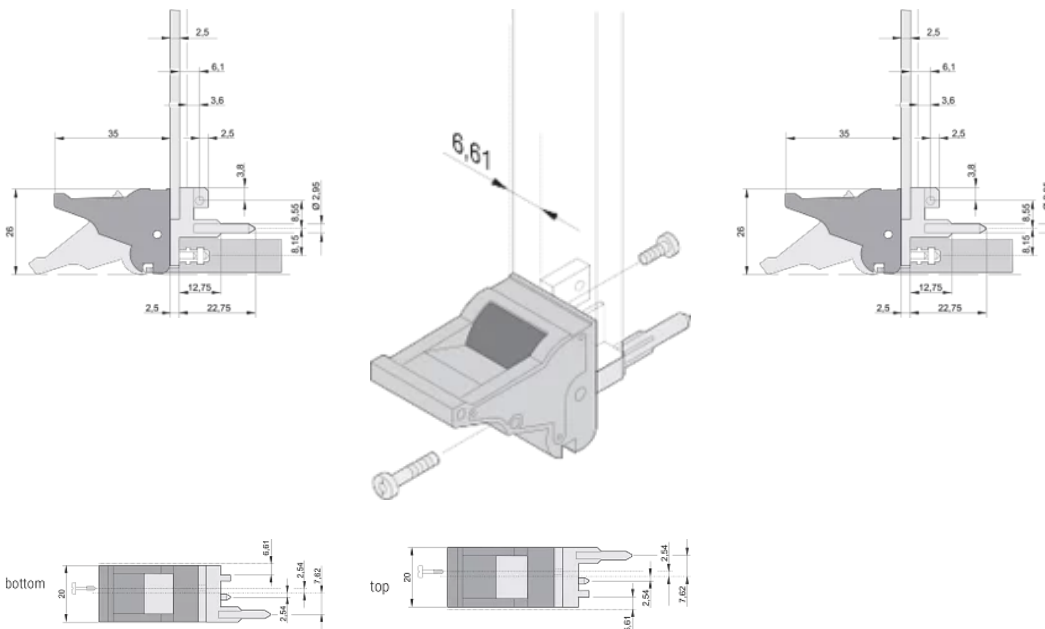

WARNING

nVent products shall be installed and used only as indicated in nVent's product instruction sheets and training materials. Instruction sheets are available at www.nvent.com and from your nVent customer service representative. Improper installation, misuse, misapplication or other failure to completely follow nVent's instructions and warnings may cause product malfunction, property damage, serious bodily injury and death and/or void your warranty.

North America

All locations

+1.763.422.2661

Chat with us:

nvent.com/schroff

Europe

Straubenhardt, Germany

+49.7082.794.0

Betschdorf, France

+33.3.88.90.64.90

Warsaw, Poland

+48.22.209.98.35

Assago, Italy

+39.02.932.7141

Chat with us:

nvent.com/schroff

Asia

Shanghai, China

+86.21.2412.6943

Qingdao, China

+86.532.8771.6101

Singapore

+65.6768.5800

Shin-Yokohama, Japan

+81.45.476.0271

Chat with us:

nvent.com/schroff

Middle East & India

Dubai, United Arab

Emirates

+971.4.378.1700

Bangalore, India

+91.80.6715.2001

Istanbul, Turkey

+90.216.250.7374

Chat with us:

nvent.com/schroff



Our powerful portfolio of brands:

CADDY

ERICO

HOFFMAN

ILSCO

SCHROFF

TRACHTE