

Telescopic Slide Universal, 2 U, 2 U 457L

CATALOG NUMBER

20110-103

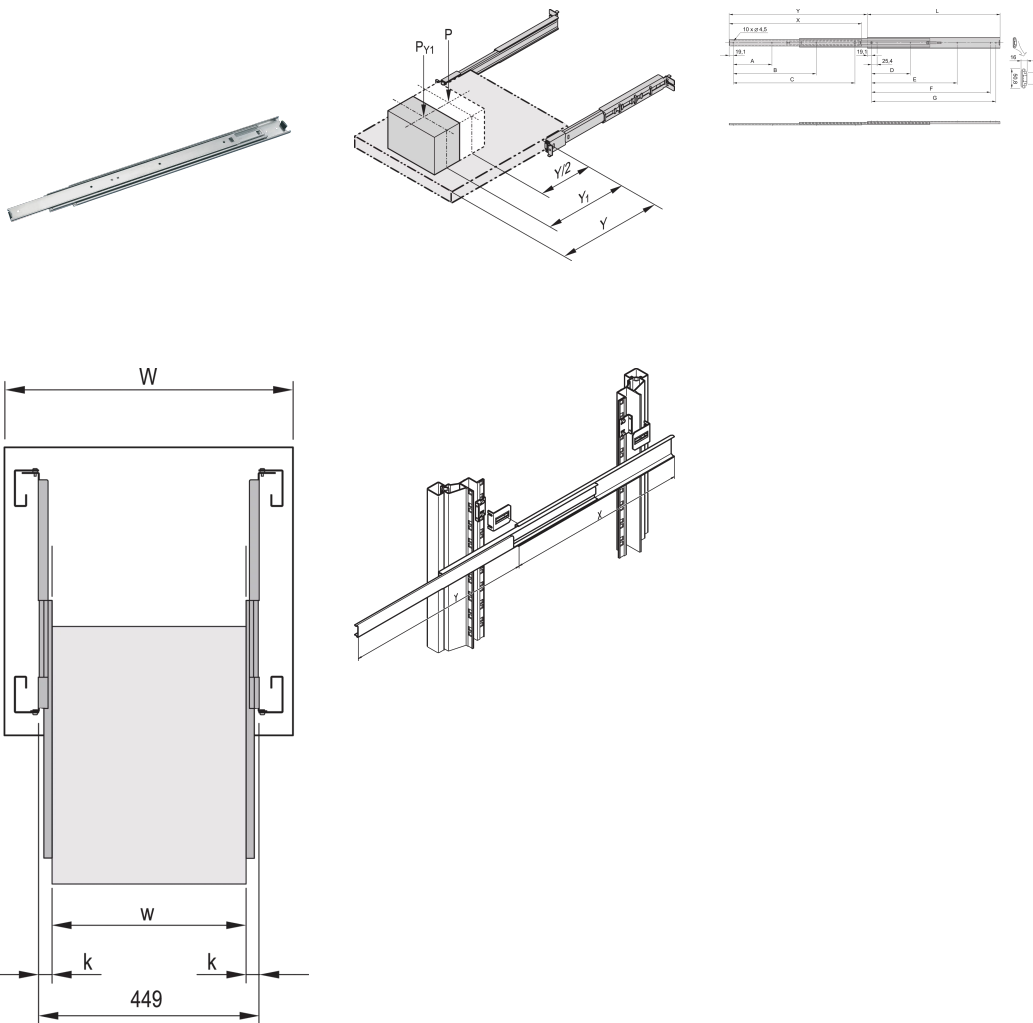

Universal Telescopic Slide with > 100 % extension and up to 61 kg load capacity.

CERTIFICATIONS



FEATURES

Rail width k = 16 mm, max. installation width of extension/drawer w = 417 mm

Lateral mounting on the 19" uprights (19" plane remains free for fixing of the extension/drawer)

Locking at full extension

Extension length > 100 %

Static load-carrying capacity per pair 46 - 61 kg

PRODUCT ATTRIBUTES

Length: 457mm

Package Quantity: 2

Finish: Zinc Plated

Material: Steel

Product Type: Telescopic Slide

Static Load: 57kg

Type: Universal

Net Weight: 2.075kg

ADDITIONAL PRODUCT DETAILS

To mount on 19" plane please order assembly kit separately. Universal telescopic Rails can also be fitted without additional components in non-standard applications, thus also in other than 19" cabinets.

WARNING

nVent products shall be installed and used only as indicated in nVent's product instruction sheets and training materials. Instruction sheets are available at www.nvent.com and from your nVent customer service representative. Improper installation, misuse, misapplication or other failure to completely follow nVent's instructions and warnings may cause

North America

All locations
+1.763.422.2661
Chat with us:
nvent.com/schroff

Europe

Straubenhardt, Germany
+49.7082.794.0
Betschdorf, France
+33.3.88.90.64.90
Warsaw, Poland
+48.22.209.98.35
Assago, Italy
+39.02.932.7141
Chat with us:
nvent.com/schroff

Asia

Shanghai, China
+86.21.2412.6943
Qingdao, China
+86.532.8771.6101
Singapore
+65.6768.5800
Shin-Yokohama, Japan
+81.45.476.0271
Chat with us:
nvent.com/schroff

Middle East & India

Dubai, United Arab
Emirates
+971.4.378.1700
Bangalore, India
+91.80.6715.2001
Istanbul, Turkey
+90.216.250.7374
Chat with us:
nvent.com/schroff



Our powerful portfolio of brands:

CADDY ERICO HOFFMAN ILSCO SCHROFF TRACHTE