

Guide Rail Accessory Type, Strengthened, PC, 280 mm, 2 mm Groove Width, Red

Power Utilities

KATALOGNUMMER

64568-080

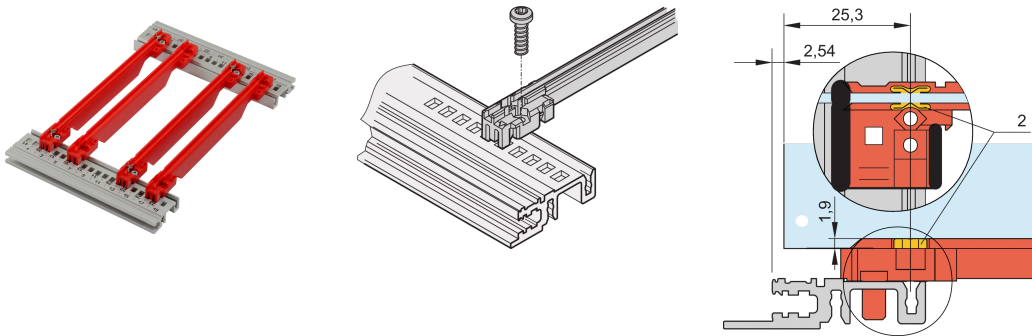

New generation of Strengthened Accessory type guide rails for PCBs or plug-in units. Forms a reliable interface between the subrack mechanics and the sub-assemblies. With the optimized design and the new high quality plastic material not just the stability was significantly increased, but also the fire safety properties improved. Which means the material ensures a low flammability, low smoke toxicity and density and fulfills the EN 45545-2 (Fire Safety in Railway Vehicle) requirements sets R22, R23 and R24 with the highest hazard level HL3. In addition the guide rails are also considered as "Halogen-Free", according to IEC 61249-2-21.

MERKMALE

NEW generation Strengthened Accessory type plastic guide rails for reliable retention of PCBs or plug-in units

Significantly increased stability, due to a high quality material (PC) and an optimized design, which also allows now the usage with rugged horizontal rails

Improved fire safety properties, fulfills EN 45545-2 requirement sets R22, R23 and R24 with HL3

"Halogen-Free", according to IEC 61249-2-21

Can be clipped into horizontal rails (Al extrusion) or into 1.5 mm thick plates

Can be bolted to the horizontal rails Type H and R for higher shock and vibration requirements

Optional ESD clip for an conductive contact between PCB and horizontal rail available

Storage temperature: from -40 °C ... 130 °C

PRODUKTMERKMALE

Produkttyp: Führungsschiene

Typ: Verstärkt

Passt zu: Baugruppenträger; Gehäuse; 19-Zoll-Einschub; Systeme

Leiterplattentiefe: 280 mm

Nutbreite: 2

Material: Polycarbonat

Farbe: Rot

Entspricht: EN 45545-2

Anzahl Verpackungen: 50

ZUSÄTZLICHE PRODUKTDDETAILS

Please take into consideration that deliveries may be carried out in the stated SPQs (SPQ, e.g. 5 pieces, 10 pieces, 50 pieces, etc.). Differing order quantities (e.g. 2 pieces) may be changed to the next possible delivery quantity = Standard Pack Quantity.

WARNUNG

nVent-Produkte müssen in Übereinstimmung mit den Produktinformationsblättern und dem Schulungsmaterial von nVent installiert und verwendet werden. Informationsblätter sind verfügbar unter www.nVent.com sowie bei Ihrem nVent-Kundendienstvertreter. Unsachgemäße Installation, Missbrauch, Fehlanwendung oder andere Handlungen im Widerspruch zu den Anweisungen und Warnungen von nVent können zu Fehlfunktionen, Anlagenschäden, schwerer Körperverletzung sowie zum Tod führen und/oder haben die Annullierung der Garantie zur Folge.



Unser starkes markenportfolio:

CADDY ERICO HOFFMAN ILSCO SCHROFF TRACHTE